

KMB001CEVAL Schematics

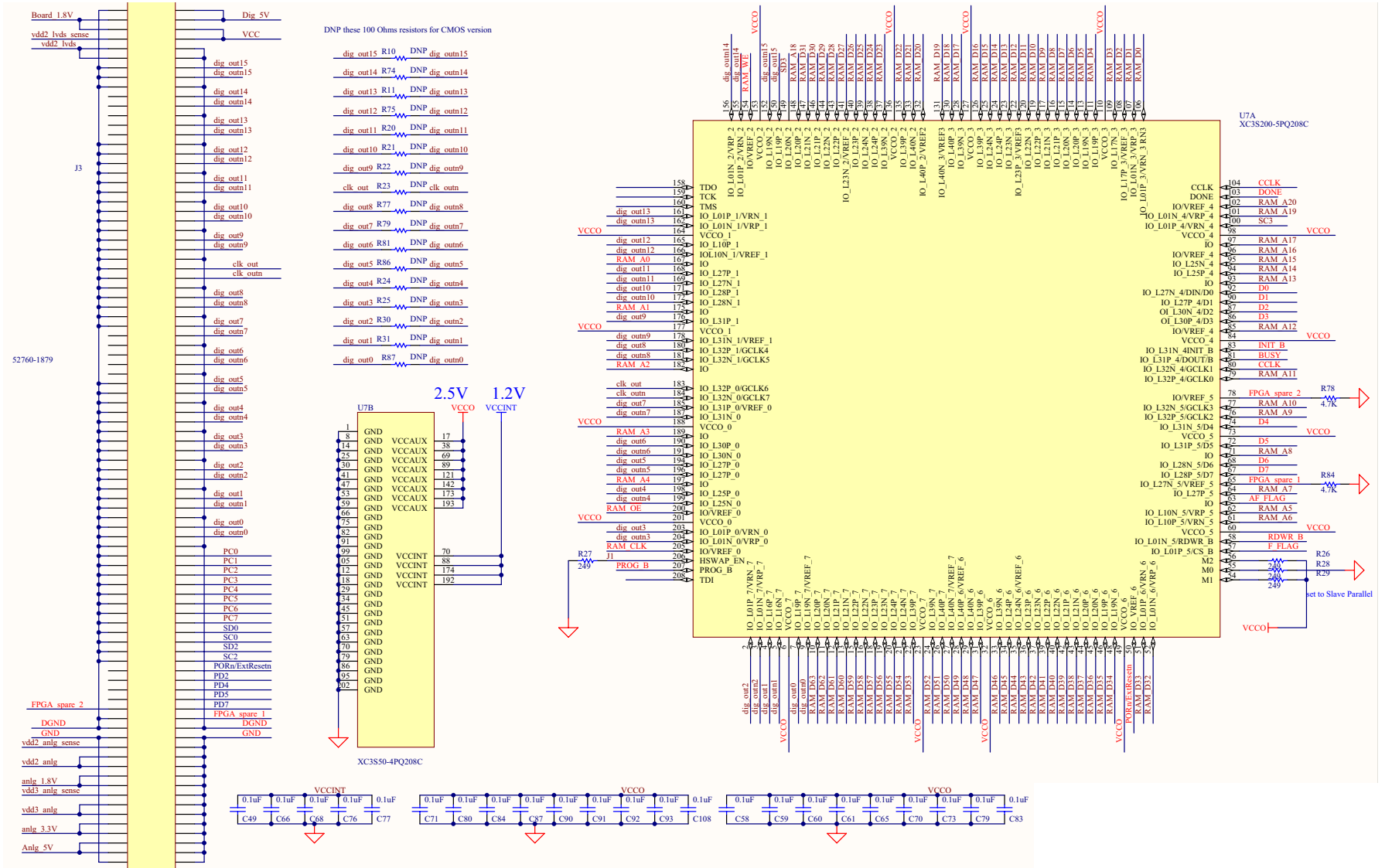

FIGURE 1. FPGA, INPUT/OUTPUT MEZZANINE CONNECTOR

KMB001CEVAL Schematics (Continued)

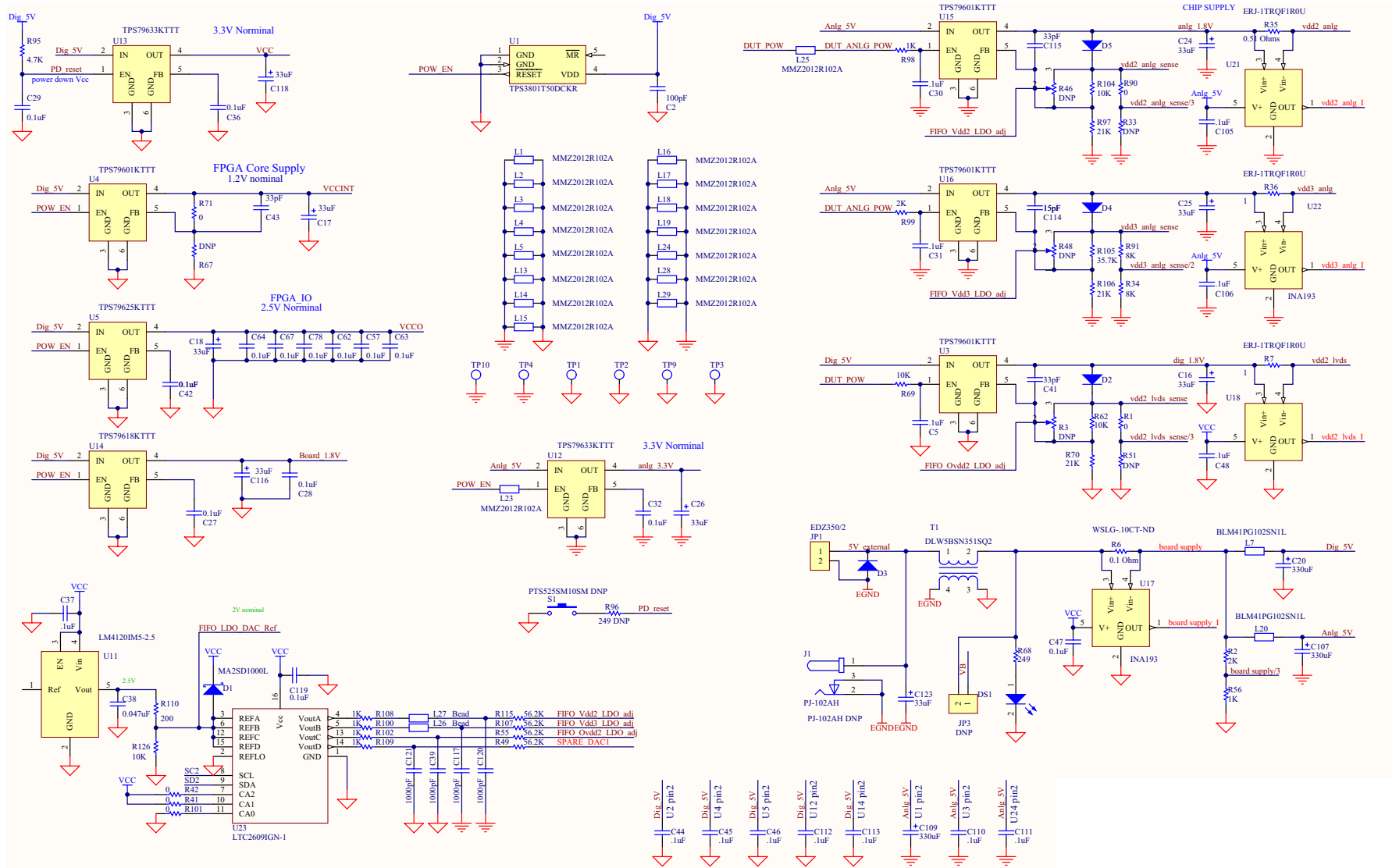

FIGURE 2. POWER

KMB001CEVAL Schematics (Continued)

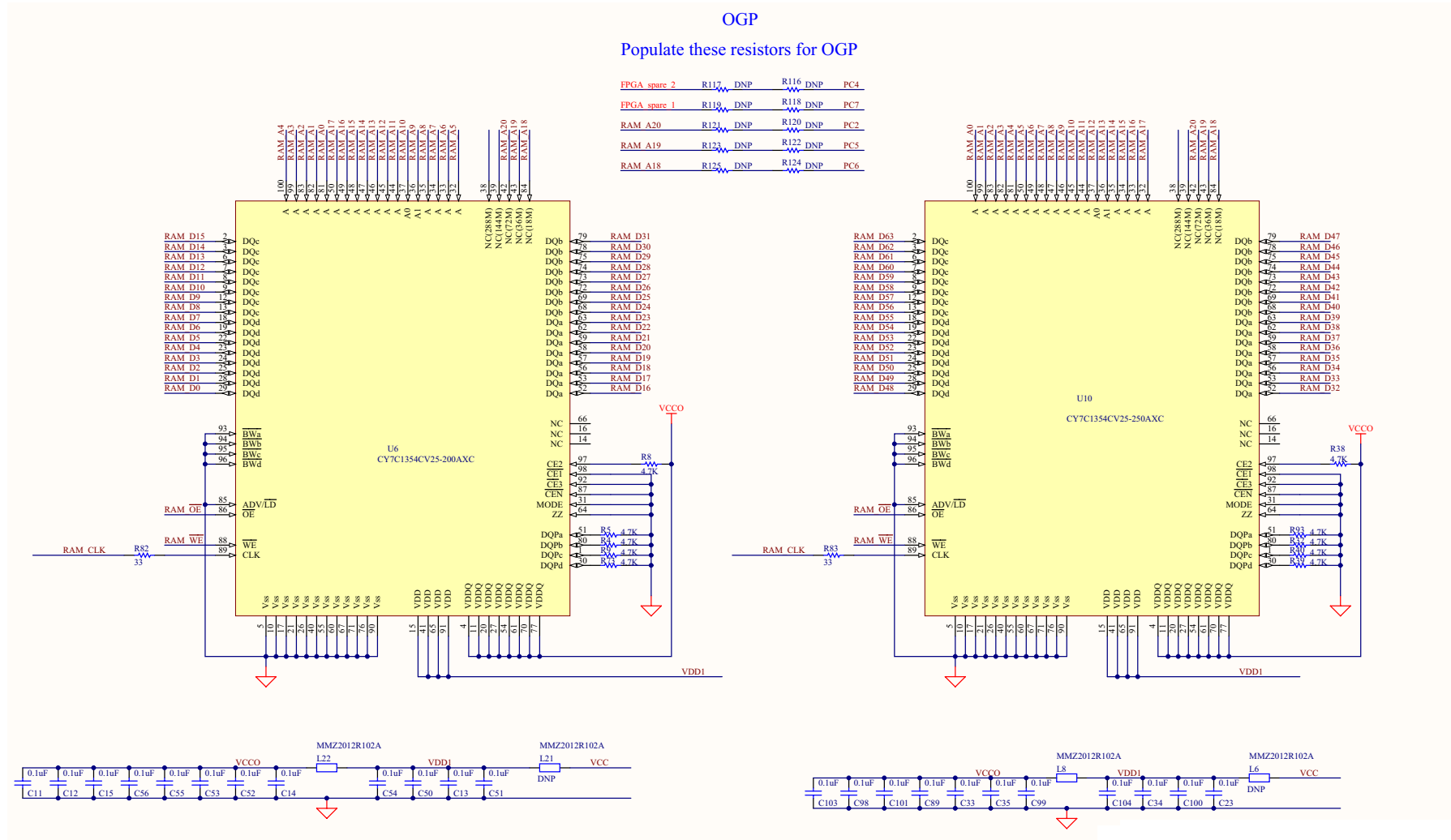

FIGURE 3. MEMORY

KMB001CEVAL Schematics (Continued)

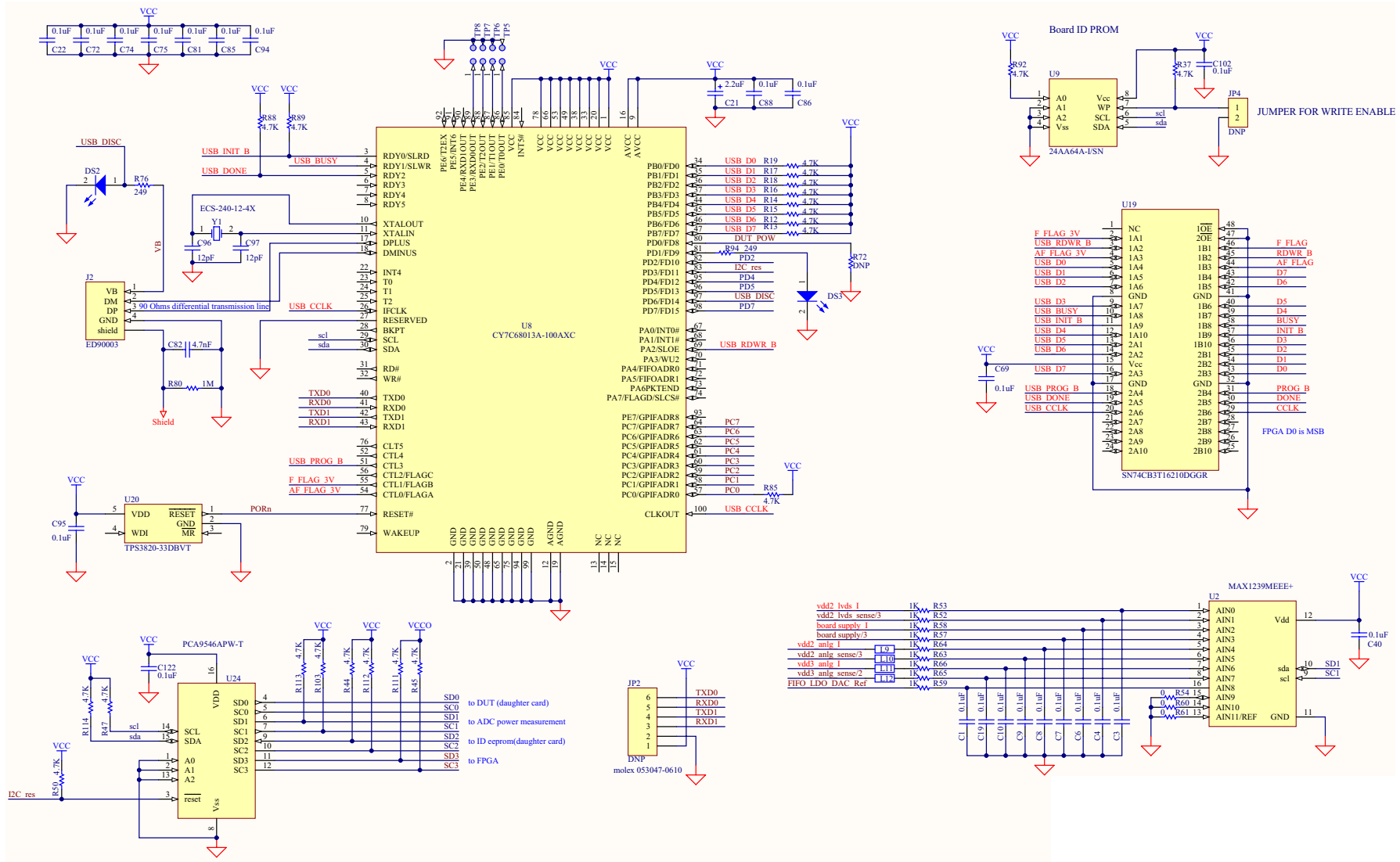

FIGURE 4. USB, MISC.

KMB001LEVAL Schematics

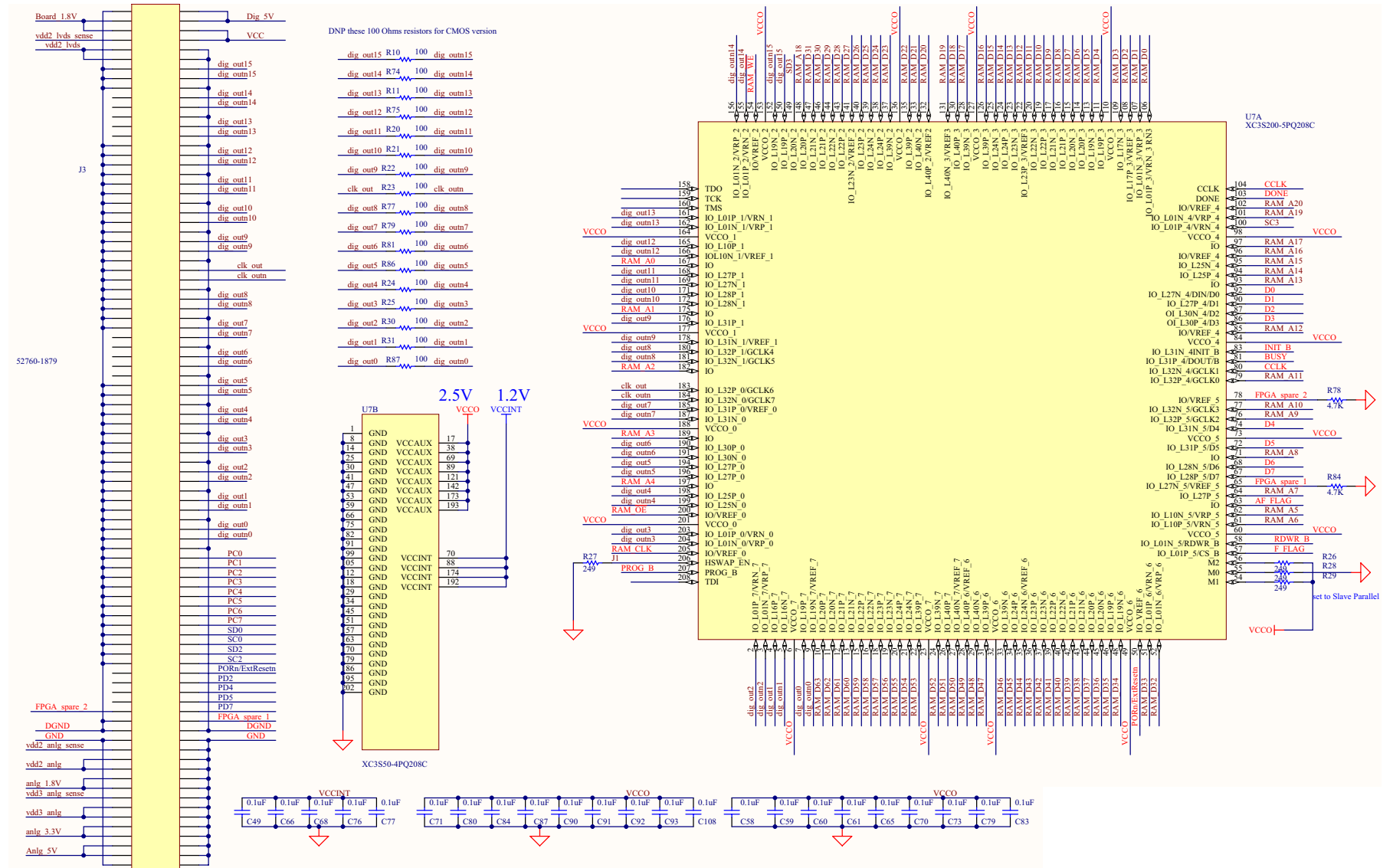

FIGURE 5. FPGA, INPUT/OUTPUT MEZZANINE CONNECTOR

KMB001LEVAL Schematics (Continued)

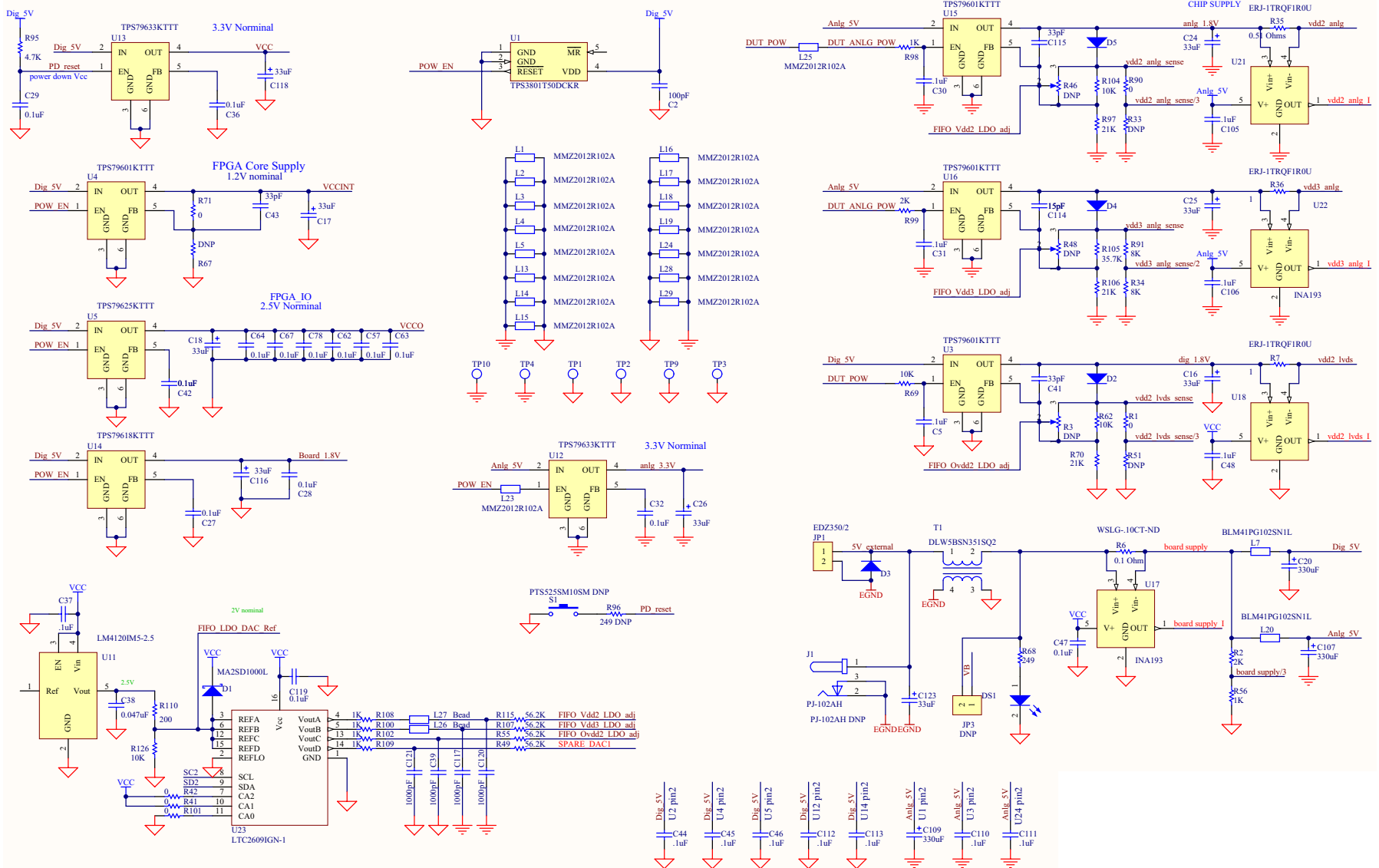
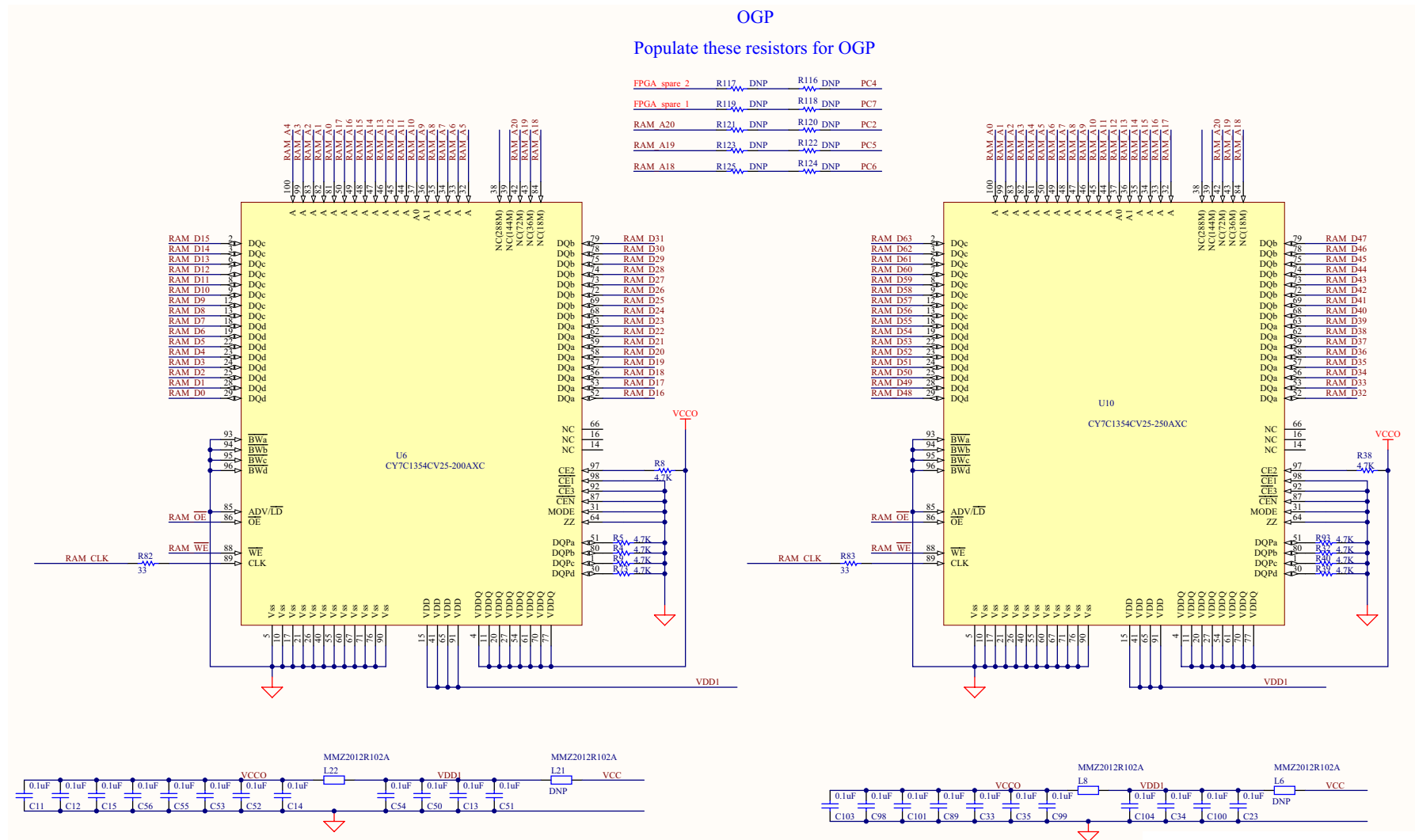

FIGURE 6. POWER

KMB001LEVAL Schematics (Continued)



KMB001LEVAL Schematics (Continued)

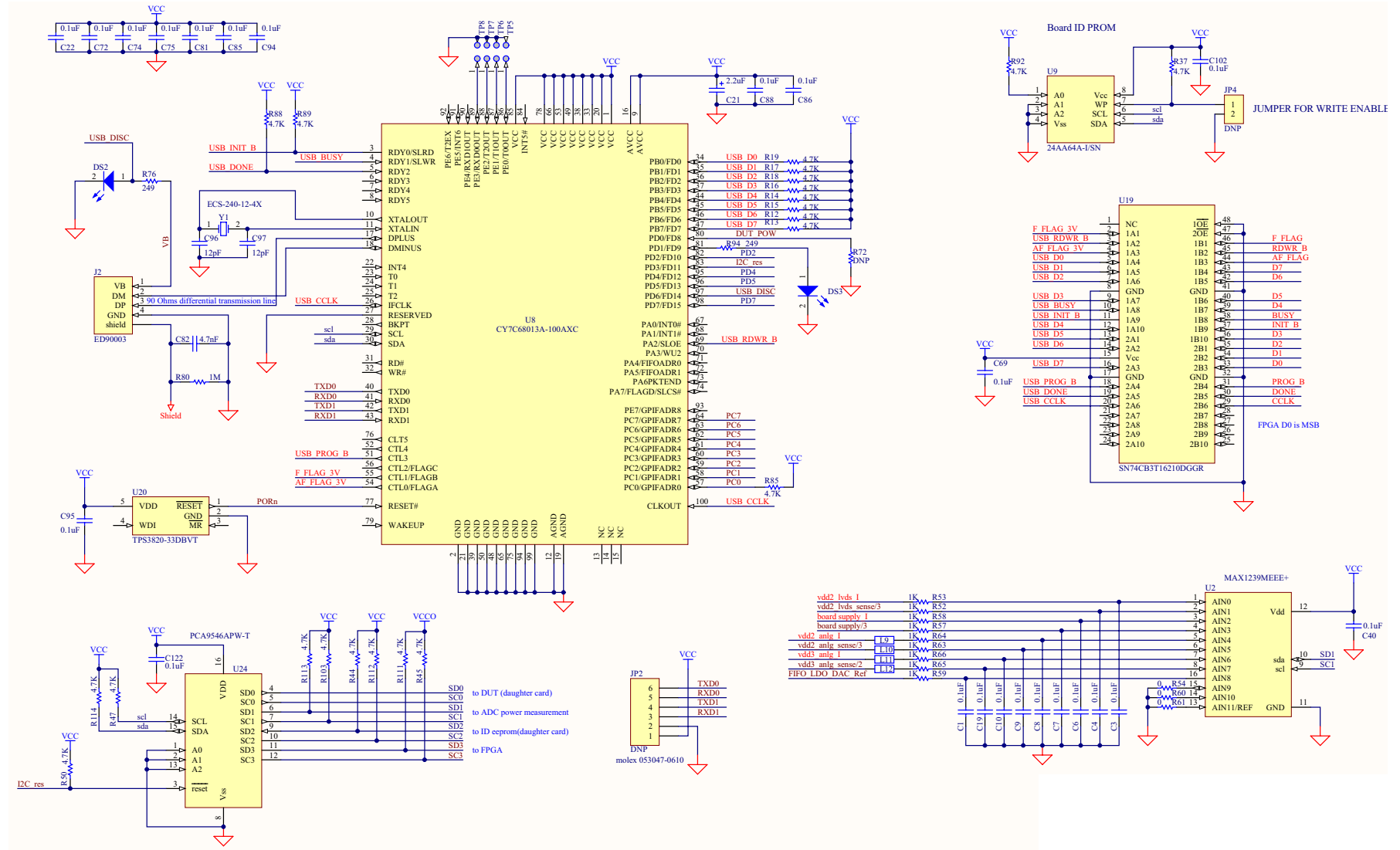

FIGURE 8. USB, MISC.

KMB001CEVAL Layers

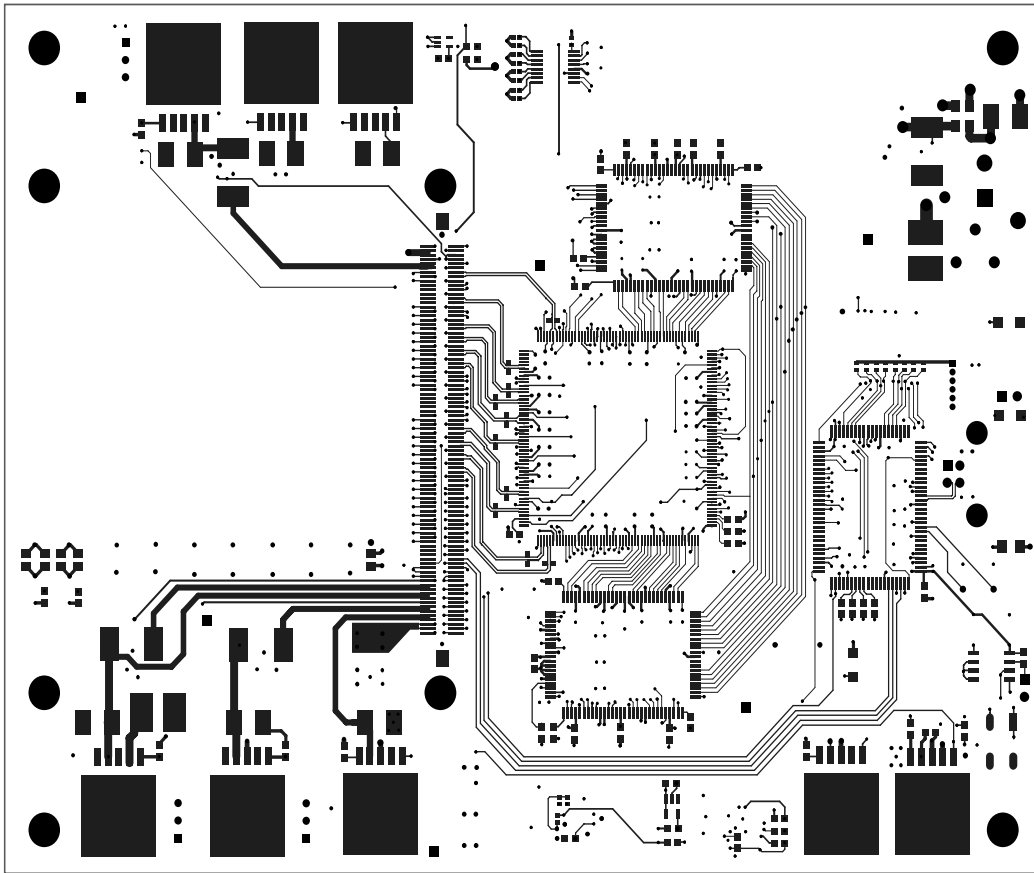

FIGURE 9. TOP LAYER

KMB001CEVAL Layers (Continued)

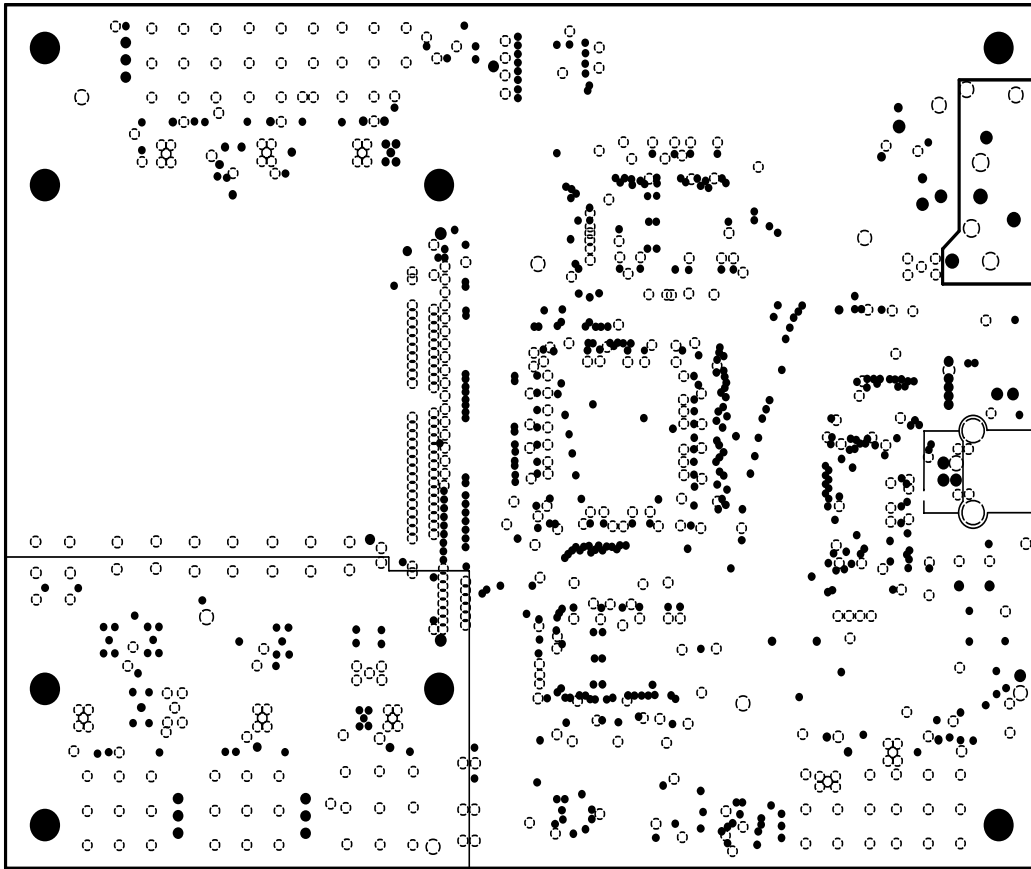

FIGURE 10. GND PLANE

KMB001CEVAL Layers (Continued)

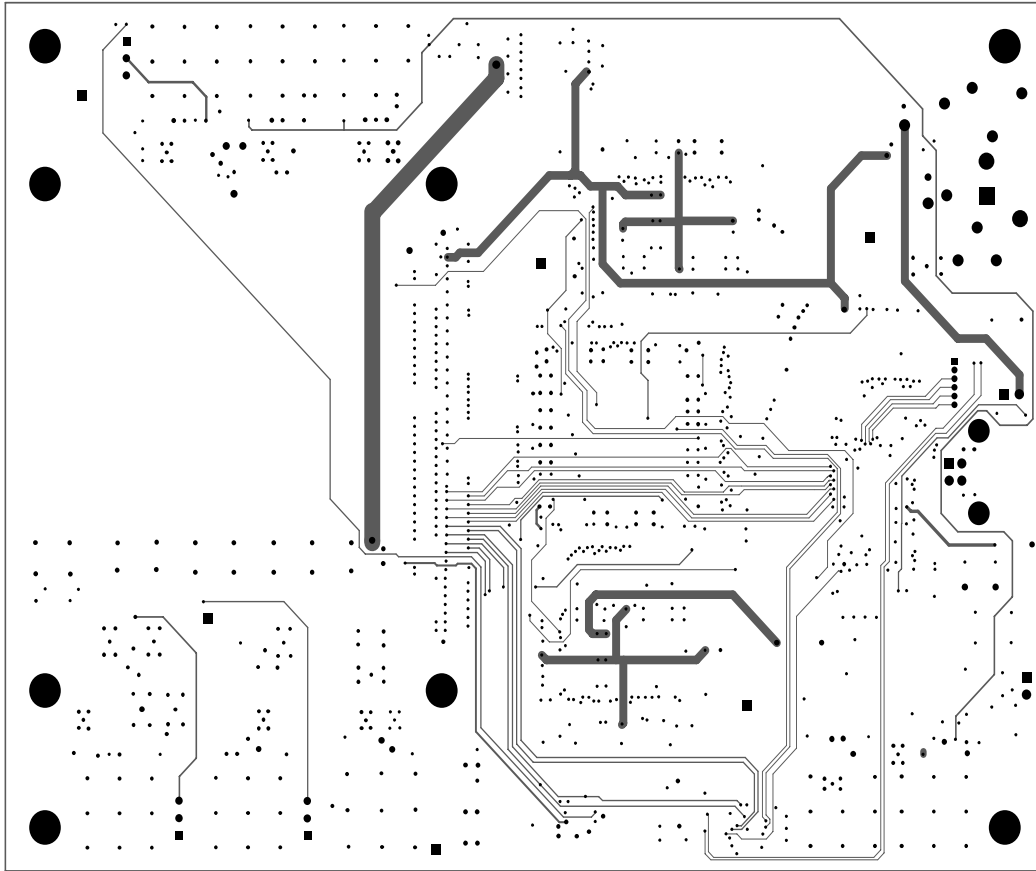

FIGURE 11. MID LAYER 1

KMB001CEVAL Layers (Continued)

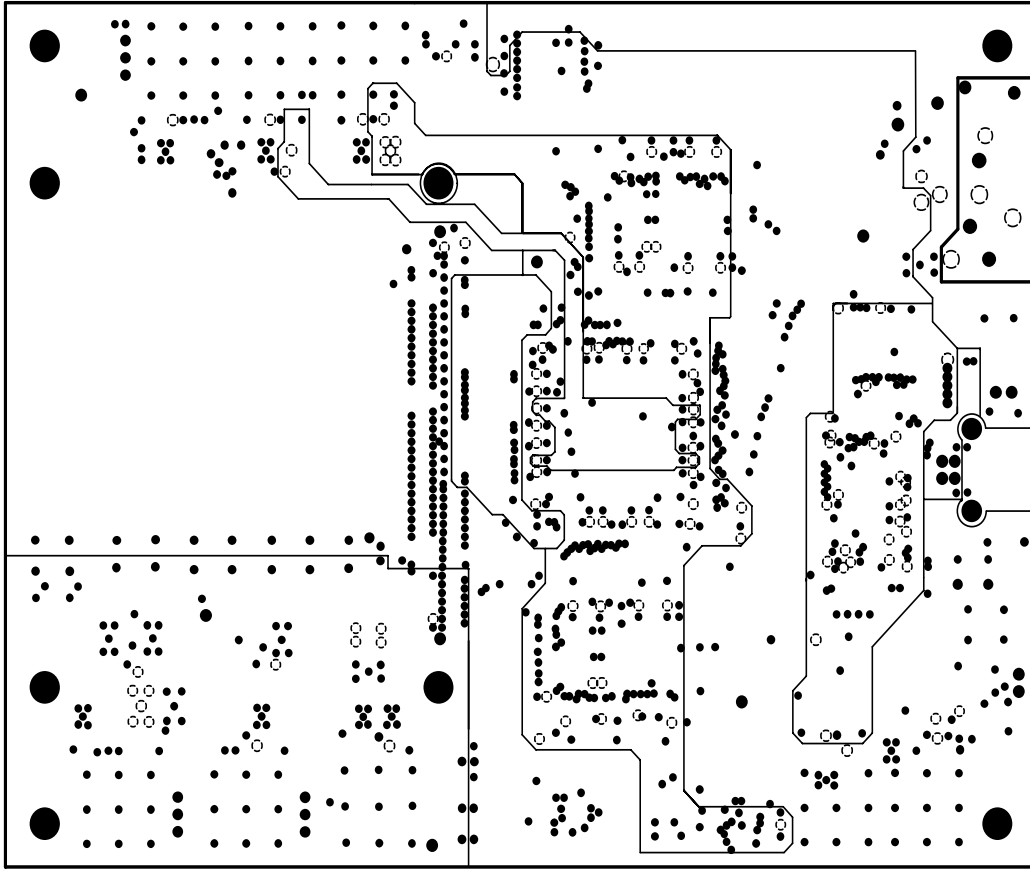

FIGURE 12. POWER PLANE

KMB001CEVAL Layers (Continued)

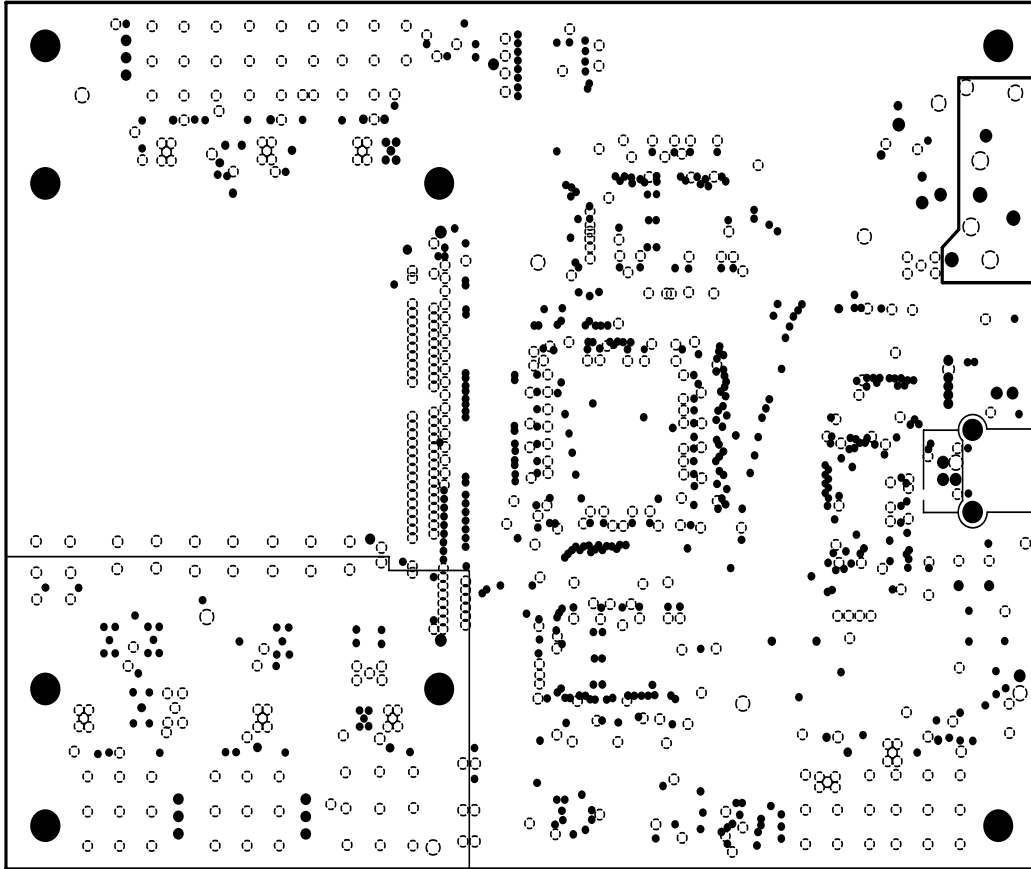

FIGURE 13. GND PLANE 2

KMB001CEVAL Layers (Continued)

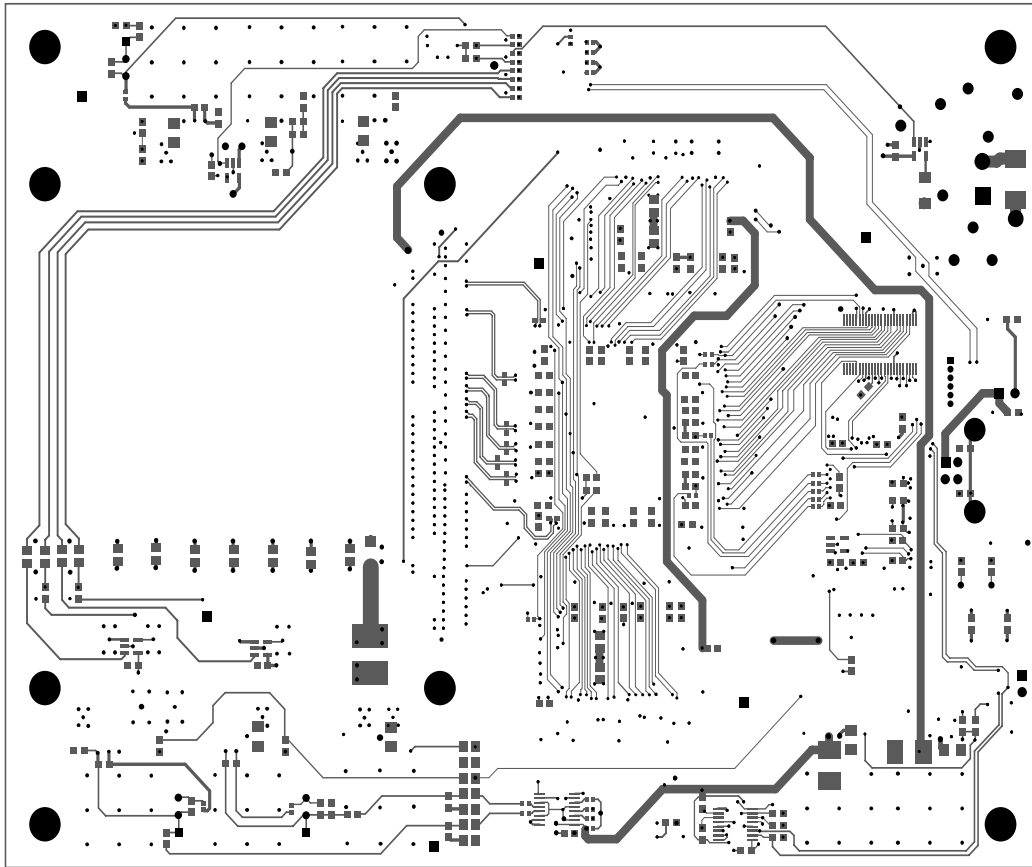

FIGURE 14. BOTTOM LAYER

KMB001CEVAL Layers (Continued)

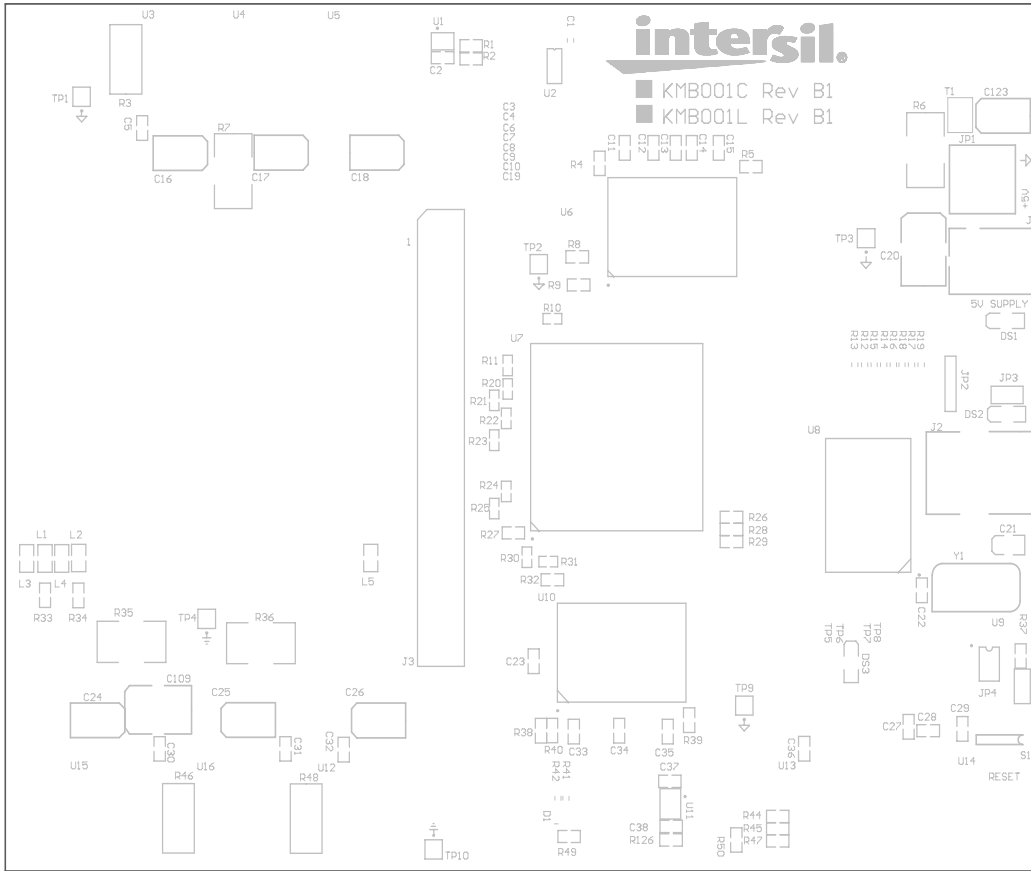

FIGURE 15. TOP OVERLAY

KMB001CEVAL Layers (Continued)

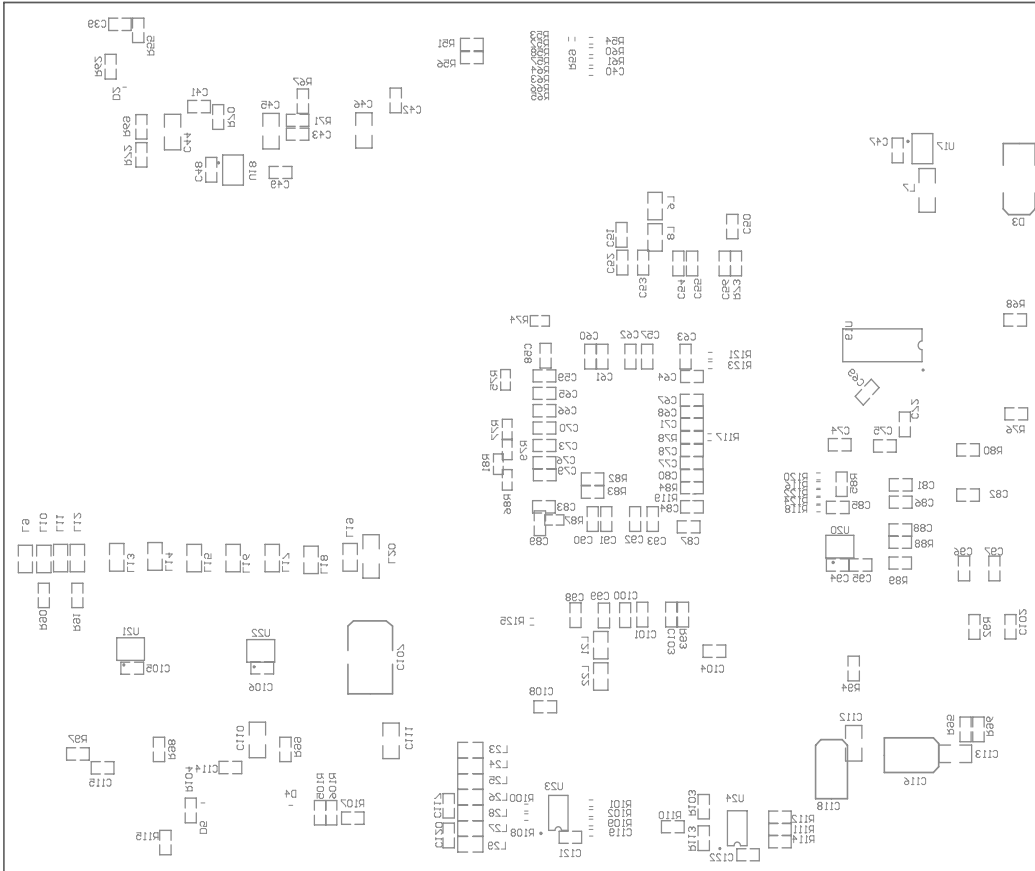

FIGURE 16. BOTTOM OVERLAY

Intersil Corporation reserves the right to make changes in circuit design, software and/or specifications at any time without notice. Accordingly, the reader is cautioned to verify that the Application Note or Technical Brief is current before proceeding.

For information regarding Intersil Corporation and its products, see www.intersil.com