

IND-TOF-1

Compact, rugged Time-of-Flight distance sensor,
6 operating modes and industrial communication protocol

Key features

- Up to 12.5 meter range, Time-of-Flight technology
- IP65 rated enclosure
- 6 operating modes based on distance thresholds
- RS485 (Modbus) interface for distance-to-target feedback
- NO/NC switching output (0-24V) for threshold notification
- Integrated teach-in buttons for quick on-the-field programming
- Compact form-factor, 99 grams

Application examples

- Object presence detection and counting
- Object sorting for size
- Material level monitoring
- Monitoring object position tolerances
- Robot positioning tasks
- Height warning for vehicle entry
- Distance measurement applications



Operation and indicators

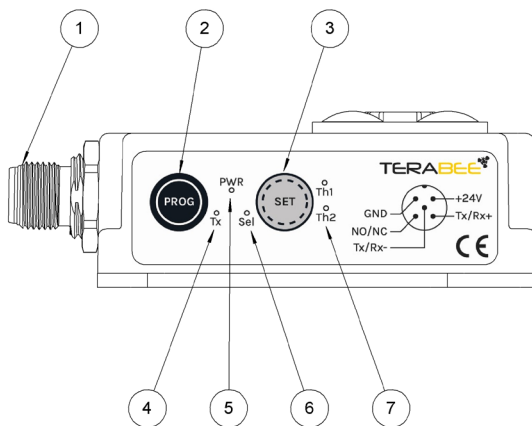

Communication

- | | | |
|---|-----|-------------------------------|
| 1 | M12 | A-coded male connector, 5-pin |
|---|-----|-------------------------------|

Teach-in buttons

- | | | |
|---|------|------------------------------|
| 2 | PROG | Program background threshold |
| 3 | SET | Program threshold 1 and 2 |

LED indicators

- | | | | |
|---|-----------|---|-----------|
| 4 | Tx | RS485 data transmission | Red |
| 5 | PWR | Power indicator | Red |
| 6 | Sel | Sensor selected | Blue |
| 7 | Th1 / Th2 | Threshold breach notification, error indication | Green/Red |

Technical specifications

Product code	TB-IND-TOF-1-RS485
Performance	
Detection Principle	Infrared Time-of-Flight
Range ⁽¹⁾	0.5 m to 12.5 m
Output Resolution	5 mm
Accuracy ⁽¹⁾	±4 cm in the first 4 m, ±1% beyond 4 m
Repeatability ⁽¹⁾⁽²⁾	±5 mm
Field of View	Approx. 2°
Projected Reception Area	10.5 cm × 10.5 cm @ 3 m range
Light Source Wavelength	940 nm
Access Time for Distance Measurements	11 ms
Response Time for NO/NC State Change ⁽³⁾	35 ms to 100 ms
Electronics	
Supply Voltage V_{IN}	24V _{±5%} DC
Current Consumption (max. @ V_{IN} = 24V DC)	90 mA
Warm-up Time (advised)	≥ 15 min
Initialization Time	< 1 s
Interfaces	
Digital Output	Switching (NO/NC in PNP/NPN configuration), 0V - 24V Maximum output current: 450 mA (@ V_{IN} = 24V DC), unfused
Serial Interface (distance measurement and remote settings)	RS485 (half-duplex, 19.2 kbps)
Communication Protocol	Modbus
Visual Notification	5 x LEDs (multicolor)
Mechanics	
Dimensions (L×W×H)	94 mm x 56 mm x 31 mm
Weight	99g
Enclosure Rating	IP65
Housing Material	Main body: ABS Backplate: Aluminium
Type of Connection	M12 A-coded male connector, 5-pin
Ambient Temperature Operation (@ V_{IN} = 24 V DC)	-20°C to +45°C
Mounting Style	4 slots for M4 screws
Conformity	
Reference Standard	CE, RoHS, Eye-Safety, Vibration & Shock ⁽⁴⁾









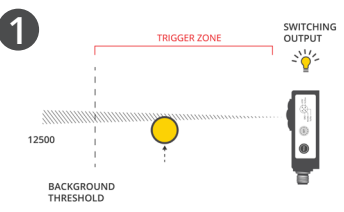

(1) Specifications are derived from tests in controlled conditions (target with 80% diffuse reflectivity, indoor fluorescent lighting, ambient temperature around 25°C). Note that bright sunlight, target surface reflectivity and other variables can affect sensor performance

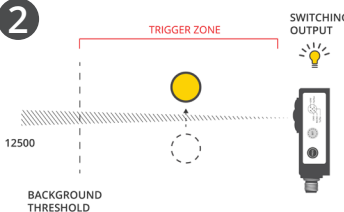
(2) Evaluated as one standard deviation over multiple measurements

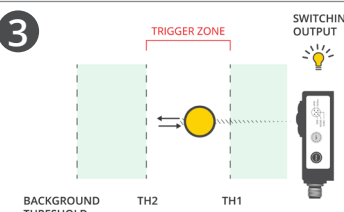
(3) Applicable to modes 1 and 3

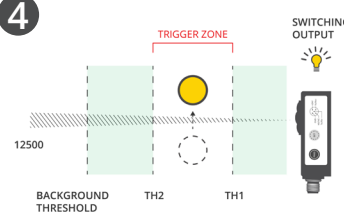
(4) Refer to conformity certificates in the User Manual for details

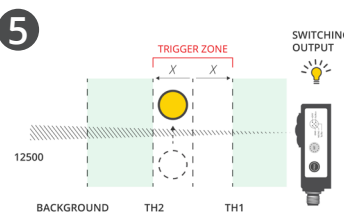
Embedded operating modes

Operating mode	Setup	Operation		Application examples
		Switching output	Distance data	
1 	1 threshold  x1	Output is triggered as soon as an object BREAKS the light beam in the trigger zone. Output remains triggered as long as the light beam in the trigger zone is broken.	Available via RS485 (Modbus)	<ul style="list-style-type: none"> • Presence detection • Robot positioning • Alarm applications
2 	1 threshold  x1	Output is triggered as soon as an object LEAVES the light beam in the trigger zone.*	Available via RS485 (Modbus)	<ul style="list-style-type: none"> • Counting applications
3 	3 thresholds  x1  x2	Output is triggered as soon as an object ENTERS the trigger zone. Output remains triggered as long as the light beam in the trigger zone is broken.	Available via RS485 (Modbus)	<ul style="list-style-type: none"> • Stock level monitoring • Approach position monitoring
4 	3 thresholds  x1  x2	Output triggered as soon as an object LEAVES the trigger zone of the light beam.*	Available via RS485 (Modbus)	<ul style="list-style-type: none"> • Counting applications, • Height monitoring • Object sorting by size
5 	3 thresholds  x1	Output triggered as soon as an object LEAVES the trigger zone of the light beam.*	Available via RS485 (Modbus)	<ul style="list-style-type: none"> • Monitoring object position tolerances
6 	No setup	No switching output	Available via RS485 (Modbus)	<ul style="list-style-type: none"> • Distance measurement applications

* The sensor is not triggered while the light beam in the trigger zone is broken (applicable to mode 2, 4 and 5)

Please refer to the Terabee IND-TOF-1 User Manual for instructions on mode setup and operation

Dimensions

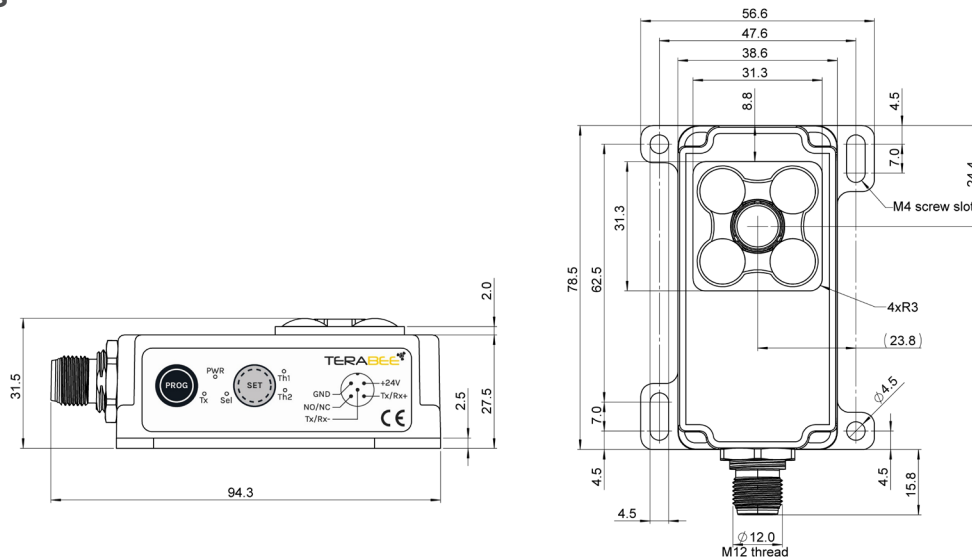

Connector pinout

Pin	Designator	Description
1	+24V	24V DC power supply
2	GND	Ground (power supply and data)
3	NO/NC	Normal Open or Normal closed (PNP/NPN) connection
4	Tx/Rx+	RS485 differential line
5	Tx/Rx-	RS485 differential line

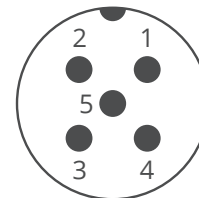

M12 A-coded male connector

Projected reception area

