

Peak Emission Wavelength: 660nm

The MTE2066N3-UR is a red 5mm water clear emitter designed for applications requiring high brightness and high reliability in a wider angle package with straight leads.

FEATURES

- > High Luminous Intensity
- > High Reliability / High Power Output
- > Excellent Optical / Mechanical Axis Alignment
- > Wide Beam Angle

APPLICATIONS

- > Optical Sensing
- > Machine Vision
- > Bar Code Scanning / Edge Sensing
- > Fiber Optical Communications

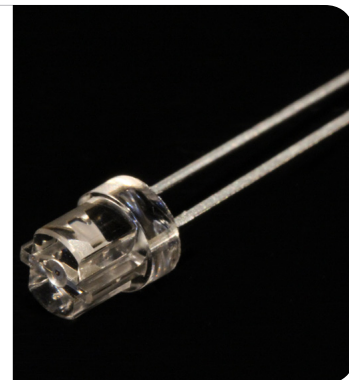

Absolute Maximum Ratings (Ta=25°C)



ITEMS	SYMBOL	RATINGS	UNIT
Forward Current (DC)	IF	50	mA
Forward Current (Pulse)*1	IFP	0.5	A
Reverse Voltage	VR	5	V
Power Dissipation	PD	120	mW
Operating Temperature Range	Topr	-20 ~ +80	°C
Storage Temperature Range	Tstg	-30 ~ +100	°C
Junction Temperature	Tj	100	°C
Lead Soldering Temperature*2	Tls	260	°C

*1: Tw=10μsec, T=10msec. *2: Time 5 Sec max, Position: Up to 3mm from the body.

Electrical & Optical Characteristics (Ta = 25°C)

ITEMS	SYMBOL	CONDITIONS	MIN	TYP	MAX	UNIT
Power Output	PO	IF=20mA	--	8.0	--	mW
Forward Voltage	VF	IF=20mA	--	2.3	--	V
Reverse Current	IR	VR=5V	--	--	100	μA
Peak Emission Wavelength	λp	IF=20mA	--	660	--	nm
Spectral Line Half Width	Δλ	IF=20mA	--	15	--	nm
Half Intensity Beam Angle	Θ	IF=20mA	--	±40	--	deg

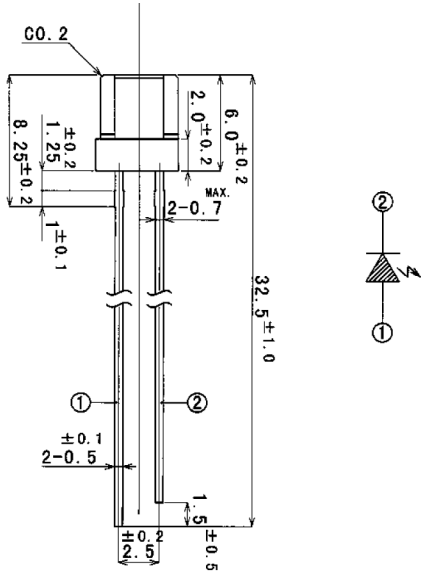

① Anode ② Cathode

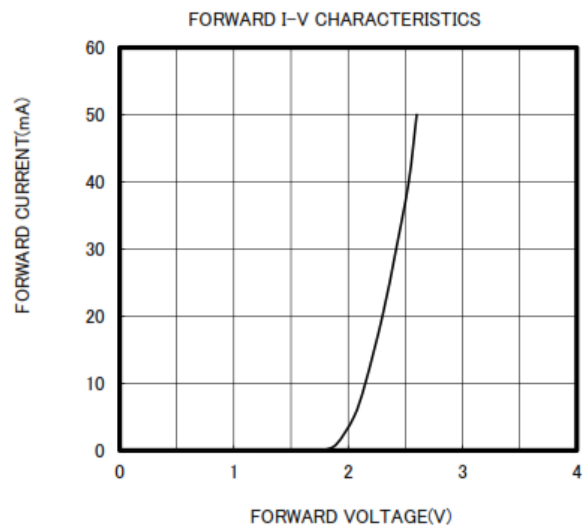
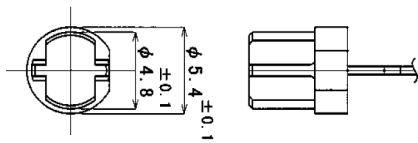
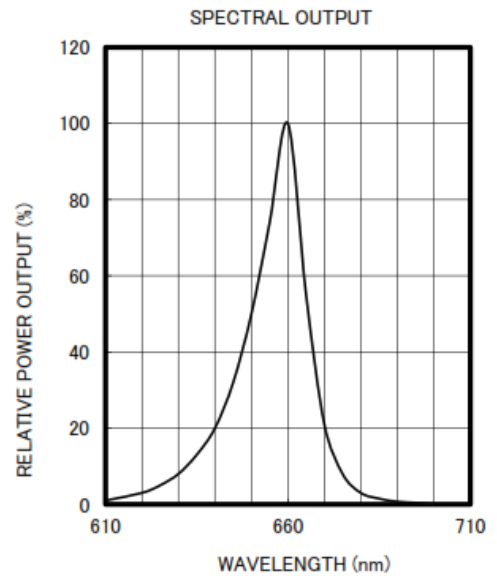

Unit: mm, Tolerance: ±0.2

THERMAL DERATING CURVE

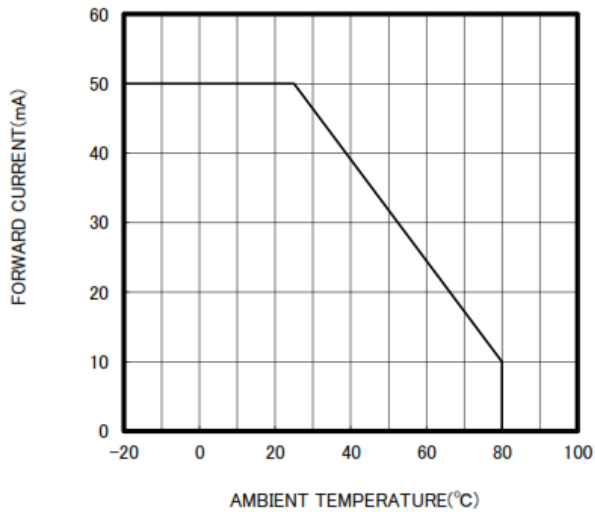

RELATIVE POWER vs FORWARD CURRENT

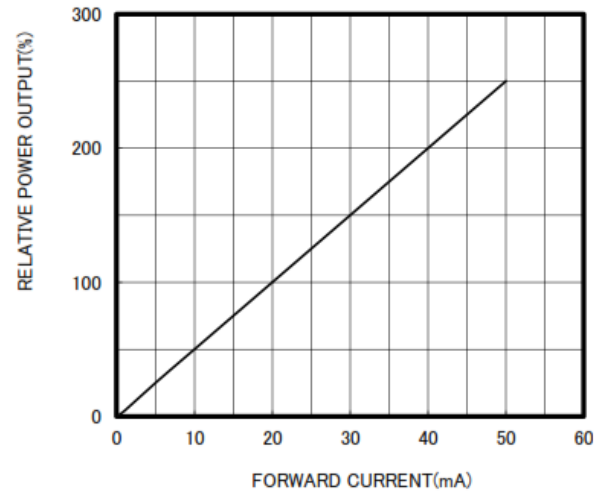

RADIATION PATTERN

