

Surface Mount  **Directional Coupler**

**DBTC-18-4-75LX+**

75Ω, 18dB coupling, 5 to 1000 MHz

**Features**

- very flat coupling
- very broadband, multi octave
- temperature stable, LTCC base
- all welded construction
- leads attached for better solderability
- micro miniature coupler
- aqueous washable
- protected by US Patents 6,140,887 & 6,784,521



Generic photo used for illustration purposes only

CASE STYLE: AT1642

**+RoHS Compliant**

The +Suffix identifies RoHS Compliance. See our web site for RoHS Compliance methodologies and qualifications

 Available Tape and Reel at no extra cost

Reel Size	Devices/Reel
7"	20, 50, 100, 200, 500
13"	1000, 2000

**Applications**

- cable tv

**Electrical Specifications at 25°C**

Parameter	Condition (MHz)	Min.	Typ.	Max.	Unit
Frequency Range		5		1000	MHz
Mainline Loss <sup>1</sup>	5-50		0.8	1.5	dB
	50-500		0.8	1.4	
	500-1000		1.0	1.6	
Nominal Coupling	5-1000		18.2±0.5		dB
Coupling Flatness(±)	5-1000			±0.7	dB
Directivity	5-50	16	25		dB
	50-500	14	21		
	500-1000	—	15		
VSWR <sup>2</sup>	5-1000		1.3		dB
Input Power	5-50			1.0	W
	50-500			1.0	
	500-1000			1.0	

1. Includes theoretical coupled power loss of 0.07 dB at 18 dB coupling.

2. For coupled port VSWR above 500 MHz, 1.6:1 typ.

**Maximum Ratings**

Parameter	Ratings
Operating Temperature	-40°C to 85°C
Storage Temperature	-55°C to 100°C

Permanent damage may occur if any of these limits are exceeded.

**Pin Connections**

Function	Pin Number
INPUT	3
OUTPUT	4
COUPLED	1
GROUND	2
ISOLATE (DO NOT USE)	6

**Product Marking**

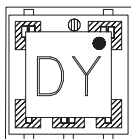

**Electrical Schematic**

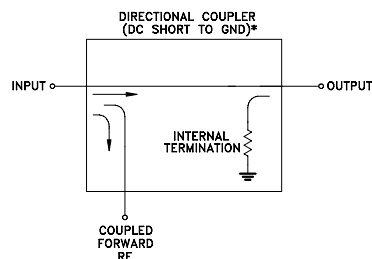

\* ELECTRICAL SCHEMATIC IS FOR DIRECTIONAL COUPLER WITH INTERNAL TRANSFORMER(S) THAT ROUTES DC FROM RF PORTS TO GROUND.



# DBTC-18-4-75LX+

## Outline Drawing

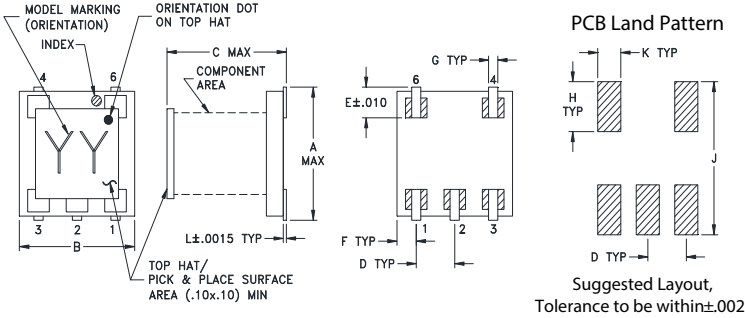

## Outline Dimensions (inch/mm)

A	B	C	D	E	F
.166	.150	.155	.050	.037	.025
4.22	3.81	3.94	1.27	0.94	0.64
G	H	J	K	L	wt
.012	.060	.184	.030	.004	grams
0.30	1.52	4.67	0.76	0.10	0.10

## Demo Board MCL P/N: TB-279 Suggested PCB Layout (PL-151)

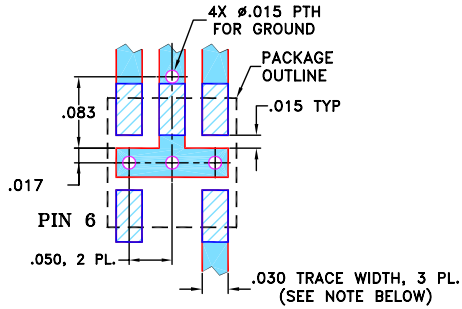

- NOTES:**
- TRACE WIDTH IS SHOWN FOR ROGERS R04350B WITH DIELECTRIC THICKNESS 0.030" ± 0.002"; COPPER: 1/2 OZ. EACH SIDE. FOR OTHER MATERIALS TRACE WIDTH MAY NEED TO BE MODIFIED.
  - BOTTOM SIDE OF THE PCB IS CONTINUOUS GROUND PLANE.

- DENOTES PCB COPPER LAYOUT WITH SMOBC (SOLDER MASK OVER BARE COPPER)
- DENOTES COPPER LAND PATTERN FREE OF SOLDER MASK

## Typical Performance Data

Frequency (MHz)	Mainline Loss (dB) In-Out	Coupling (dB) In-Cpl	Directivity (dB)	Return Loss (dB)		
				In	Out	Cpl
5.00	0.87	18.24	21.78	19.58	21.40	19.46
7.00	0.84	18.17	23.60	20.35	22.32	20.29
10.00	0.82	18.14	25.06	20.85	22.98	20.87
30.00	0.81	18.08	27.35	21.44	23.78	21.40
50.00	0.82	18.10	27.01	21.54	23.92	21.18
70.00	0.83	18.12	27.23	21.66	24.08	20.74
100.00	0.84	18.14	26.88	21.81	24.29	19.93
500.00	0.88	18.26	20.48	20.94	22.37	11.09
700.00	0.89	18.38	18.00	20.66	21.20	9.14
1000.00	0.97	18.68	14.66	21.86	20.85	7.41

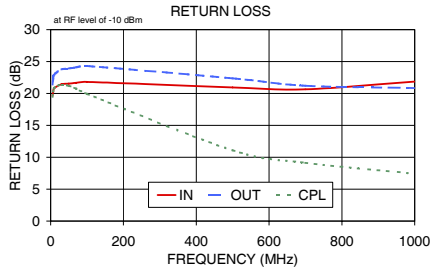
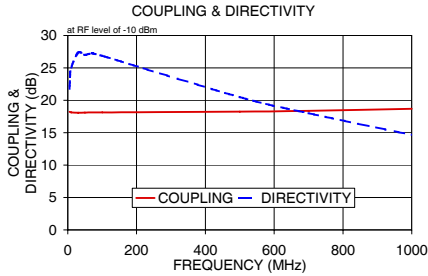
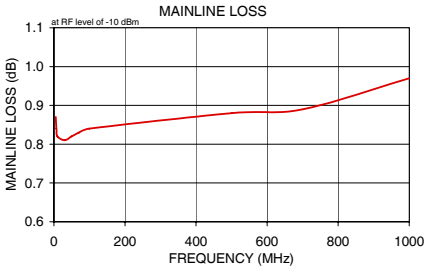

## Additional Notes

- Performance and quality attributes and conditions not expressly stated in this specification document are intended to be excluded and do not form a part of this specification document.
- Electrical specifications and performance data contained in this specification document are based on Mini-Circuit's applicable established test performance criteria and measurement instructions.
- The parts covered by this specification document are subject to Mini-Circuits standard limited warranty and terms and conditions (collectively, "Standard Terms"); Purchasers of this part are entitled to the rights and benefits contained therein. For a full statement of the Standard Terms and the exclusive rights and remedies thereunder, please visit Mini-Circuits' website at [www.minicircuits.com/MCLStore/terms.jsp](http://www.minicircuits.com/MCLStore/terms.jsp)