

SPECIFICATIONS
CDTA39R2WF1MA
OUTLINES DIMENSIONS

Notes:

1. All Dimensions are in millimeters (inches).
2. Tolerance is $\pm 0.25\text{mm}$ (0.01") unless otherwise noted.
3. Specifications are subject to change without notice.

Part Number	Chip Material	Color of Emission	Lens Type	Description
CDTA39R2WF1MA	InGaAlP	Red	White Segment	Common Anode

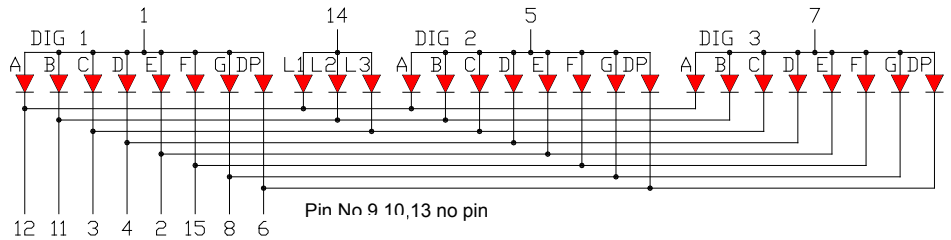
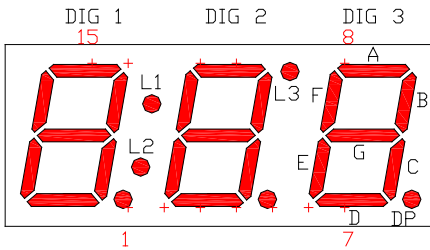
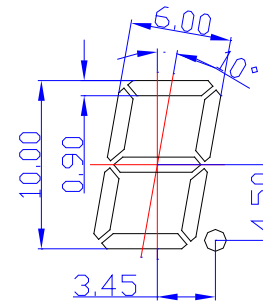
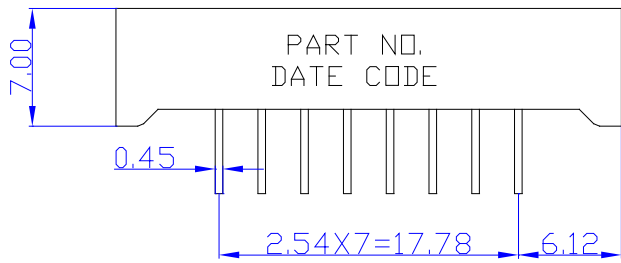
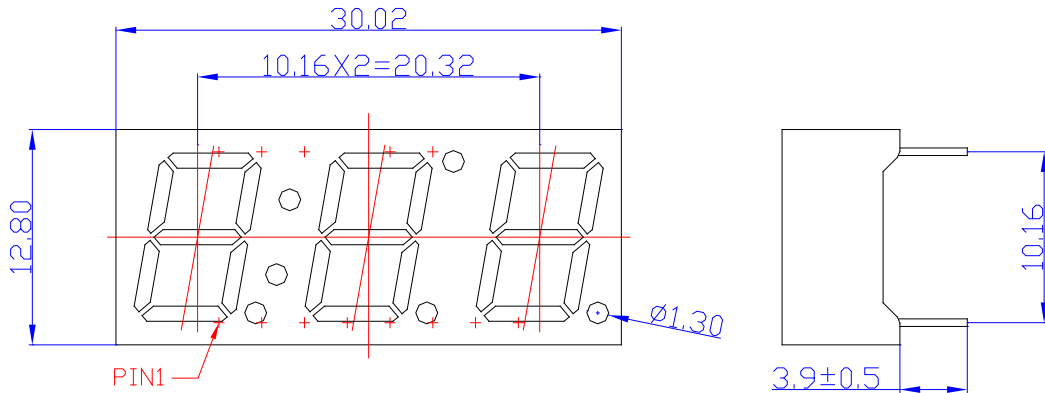

ChromeLED Corp. reserves the right to make changes at any time in order to supply the best product possible. The most current version of this document will always be available at: www.chromeled.com

ABSOLUTE MAXIMUM RATINGS
(TA=25°C)

Parameter	Symbol	Max Rating	Unit
Power Dissipation	PD	70	mW
Pulse Forward Current	IFP	90	mA
Continuous Forward Current	IF	25	mA
Reverse Voltage Segment	VR	5	V
Operating Temperature Range	TOPR	-25~+85	°C
Storage Temperature Range	TSTG	-25~+85	°C
IFP = Pulse Width ≤ 10 ms, Duty Ratio ≤1/10. Soldering Condition: 260 °C/ 5sec			

OPTICAL-ELECTRICAL CHARACTERISTICS
(TA=25°C)

Parameter	Symbol	Test Condition	Value			Unit
			Min	Typ	Max	
Luminous Intensity	IV	IF = 1mA	200	650	-	ucd
Forward Voltage	VF	IF = 1mA	-	2.0	2.6	V
Reverse Leakage Current	IR	VR = 5V	-	-	10	µA
Peak Wavelength	λP	IF = 20mA	-	650	-	nm
Dominant Wavelength	λD	IF = 20mA	-	639	-	nm
Spectral Radiation Bandwidth	Δλ	IF = 20mA	-	20	-	nm



ChromeLED Corp. reserves the right to make changes at any time in order to supply the best product possible. The most current version of this document will always be available at: www.chromeled.com

OPTICAL CHARACTERISTIC CURVES

Typical Electro-optical Characteristic Curves (25 °C Free Air Temperature Unless Otherwise Specified)

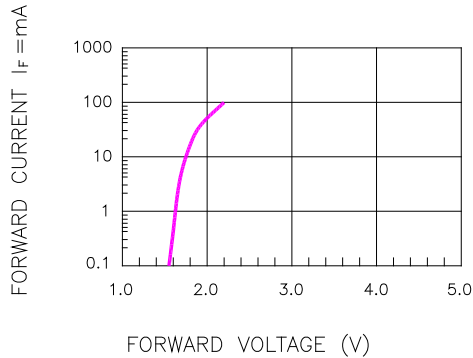

Fig.1 FORWARD CURRENT VS. FORWARD VOLTAGE

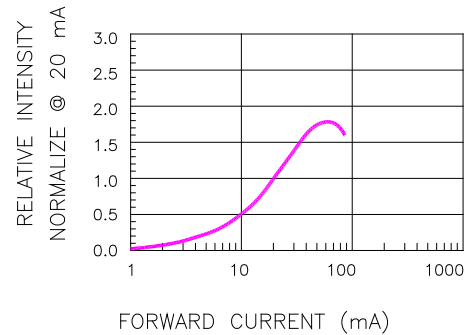

Fig.2 RELATIVE INTENSITY VS. FORWARD CURRENT

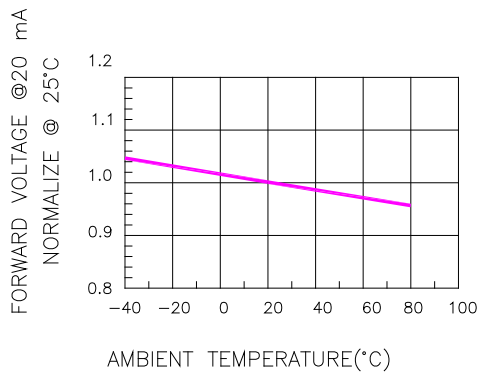

Fig.3 FORWARD VOLTAGE VS. TEMPERATURE

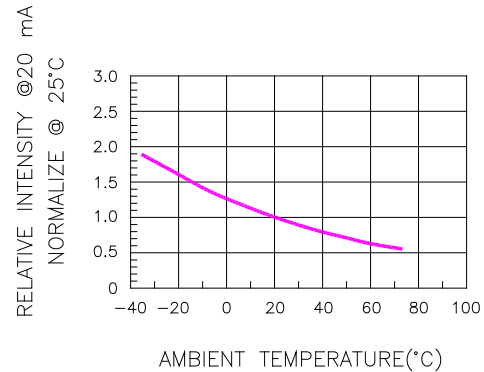

Fig.4 RELATIVE INTENSITY VS. TEMPERATURE

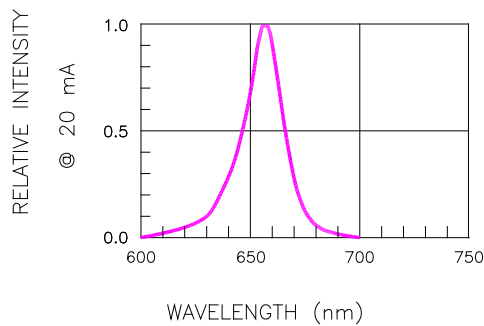

Fig.5 RELATIVE INTENSITY VS. WAVELENGTH

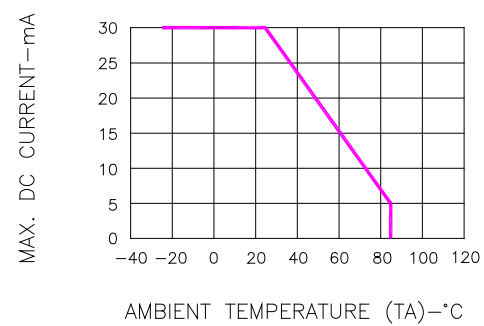

Fig.6 MAX. ALLOWABLE DC CURRENT VS. AMBIENT TEMPERATURE



ChromeLED Corp. reserves the right to make changes at any time in order to supply the best product possible. The most current version of this document will always be available at: www.chromeled.com

SOLDERING CONDITIONS – DISPLAY TYPE LED

● **RECOMMEND SOLDERING PROFILE**

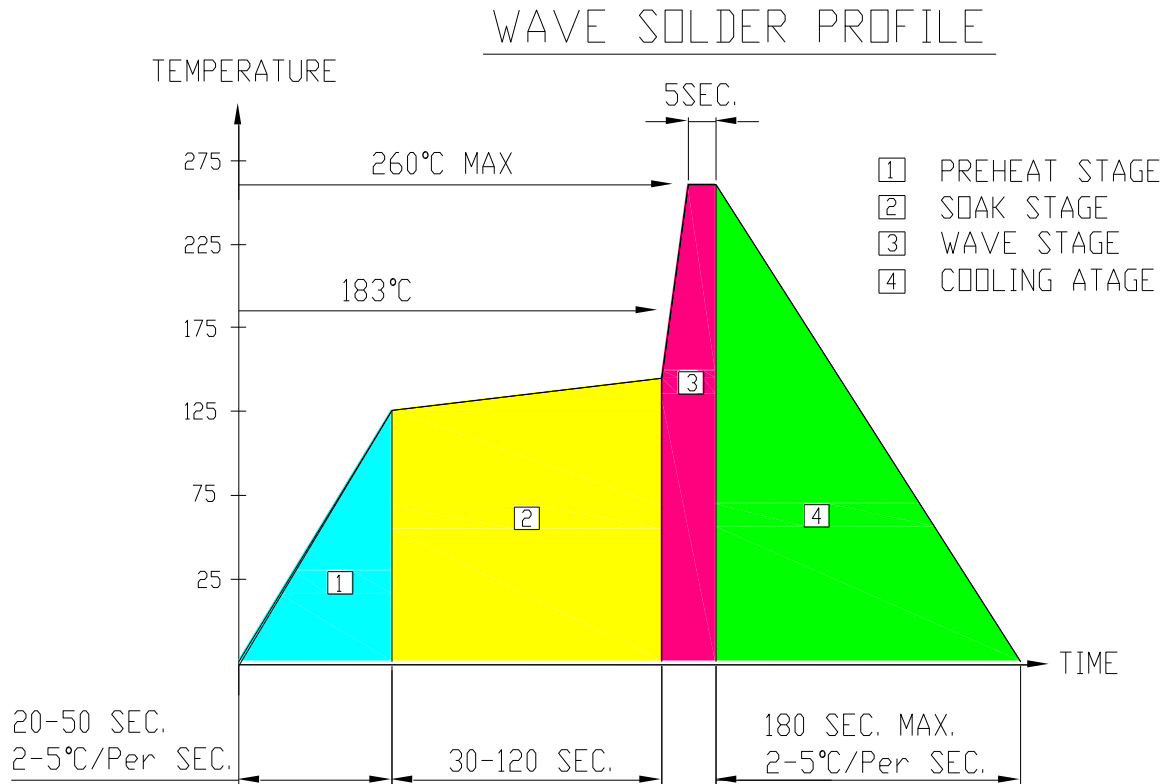

● **SOLDERING IRON**

Basic spec is ≤ 4 sec when 260°C. If temperature is higher, time should be shorter (+10°C→1 sec). Power dissipation of Iron should be smaller than 15W, and temperature should be controllable. Surface temperature of the device should be under 230°C.

● **REWORK**

Customer must finish rework within ≤ 4 sec under 245°C.



ChromeLED Corp. reserves the right to make changes at any time in order to supply the best product possible. The most current version of this document will always be available at: www.chromeled.com