

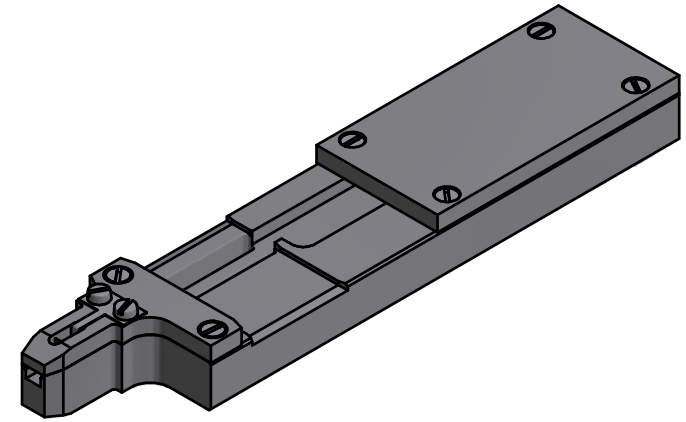

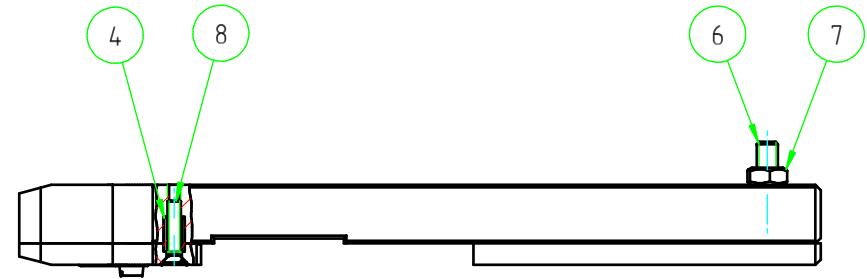

LOC	DIST	REVISIONS					
AI	00	P	LTR	DESCRIPTION	DATE	DWN	APVD
			A	INITIAL REVISION	20OCT2009	LS	DH

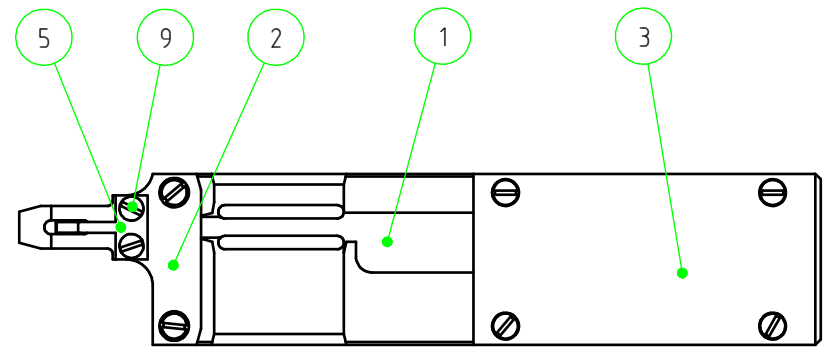

THIS DRAWING IS A CONTROLLED DOCUMENT.		DWN	14OCT2009		 TE Connectivity		
DIMENSIONS: mm		CHK	20OCT2009				
		APVD	20OCT2009				
TOLERANCES UNLESS OTHERWISE SPECIFIED: 0 PLC ± 1 PLC ± 2 PLC ± 3 PLC ± 4 PLC ± ANGLES ±		PRODUCT SPEC	NAME				
MATERIAL		APPLICATION SPEC	INSERTION TUBE ASSY Einsetztube Baugruppe		RESTRICTED TO		
FINISH		Gewicht / Weight in Kg	SIZE	CAGE CODE	DRAWING NO		
		0,402	A3	00779	1-548040-8		
CUSTOMER DRAWING					SCALE	SHEET	REV
						1 OF 2	A

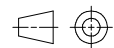
POS	QTY	TE/PN	REV	DESCRIPTION	S=Spare Parts W=Wear Parts	S	W
1	1	2-0659663-2	A	TUBE INSERTION SINGLE EINSETZTUBE 1FACH		<input checked="" type="checkbox"/>	<input type="checkbox"/>
2	1	0-0578889-8	A	GUIDE PLATE, FRONT FÜHRUNGSPLATTE, VORNE		<input checked="" type="checkbox"/>	<input type="checkbox"/>
3	1	0-0659665-1	B	GUIDE PLATE, REAR FÜHRUNGSPLATTE, HINTEN		<input checked="" type="checkbox"/>	<input type="checkbox"/>
4	4	0-0873090-1	A	BUSHING		<input checked="" type="checkbox"/>	<input type="checkbox"/>
5	1	0-0578890-7	A	SPRING FEDER		<input checked="" type="checkbox"/>	<input type="checkbox"/>
6	1	0-2030791-6	A	PLUNGER, SPRING DRUCKSTÜCK GN616		<input checked="" type="checkbox"/>	<input type="checkbox"/>
7	1	0-0519021-8	A	MUTTER M4 DIN 934 -10 GAL NI		<input checked="" type="checkbox"/>	<input type="checkbox"/>
8	6	3-0519074-0	A	COUNTERSUNK SCREW SENKSCHRAUBE		<input checked="" type="checkbox"/>	<input type="checkbox"/>
9	2	1-0519003-0	A	ZYLINDERSCHR. M2,5*3 DIN 84 -8.8 GAL NI		<input checked="" type="checkbox"/>	<input type="checkbox"/>

REMARKS: CONTACT: 1601097							USED ON 2-0529524-7-A					
P	LTR	REVISION RECORD	DATE	DWN	APVD	PRINTED	DWN	15OCT09	CHK	20OCT09	APVD	20OCT09
-	A	SEE SHEET 1	-	-	-	25JUL13	L. SANDHU		D. HEYL		D. HEYL	
-	-	-	-	-	-	WEIGHT SEE SHEET 1	DIMENSION (mm) -		MATERIAL -		HT TR -	
-	-	-	-	-	-	 TOLERANCES UNLESS OTHERWISE SPECIFIED SEE SHEET 1		 TE Connectivity SPARE AND WEAR PARTS LIST				
THIS DRAWING IS A CONTROLLED DOCUMENT FOR TYCO ELECTRONICS CORPORATION. IT IS SUBJECT TO CHANGE AND THE CONTROLLING ENGINEERING ORGANIZATION SHOULD BE CONTACTED FOR THE LATEST REVISION.											RESTRICTED TO -	
DIESES ZEICHNUNGSDOKUMENT WIRD DURCH TYCO ELECTRONICS CORPORATION KONTROLLIERT. ÄNDERUNGEN DIE DEM TECHNISCHEN FORTSCHRITT DIENEN, SIND VORBEHALTEN. DEN JEWEILS LETZTGÜLTIGEN ÄNDERUNGSSTAND ERFAHREN SIE AUF ANFRAGE												
NAME INSERTION TUBE ASSY												
SCALE SEE SHEET 1			SIZE A4		DRAWING NO C-1-548040-8			SHEET 2/2		REV A		