

Mechanical Dimensions: Inches [mm]

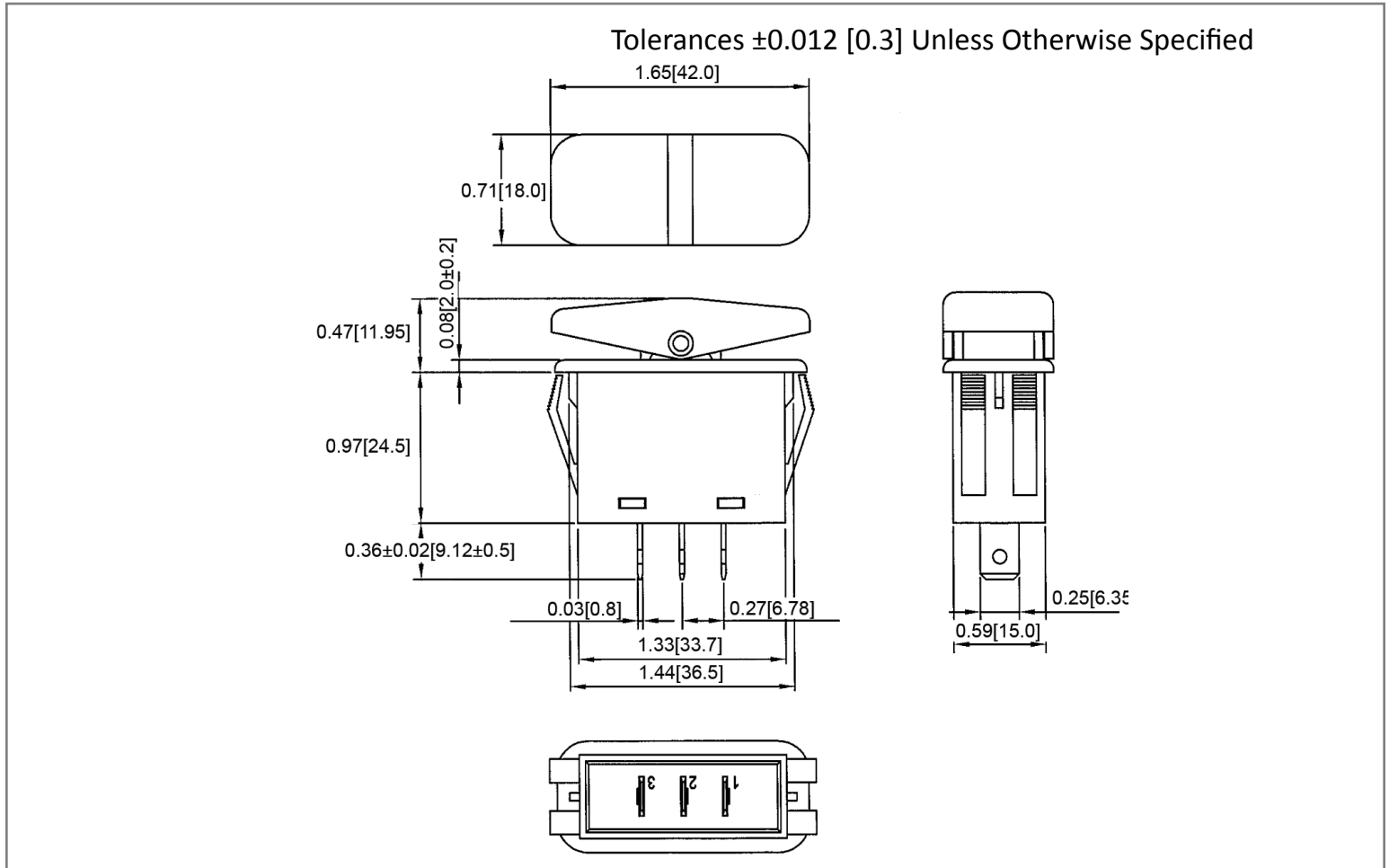

Mounting Hole

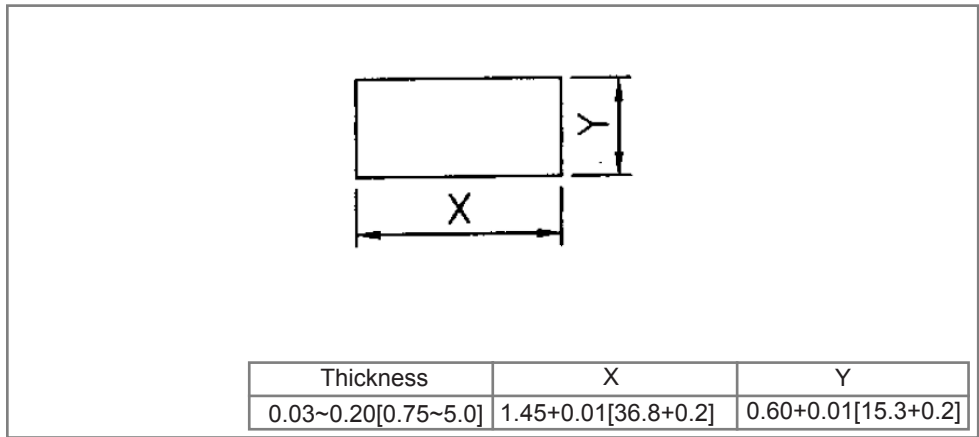

Circuit Diagram

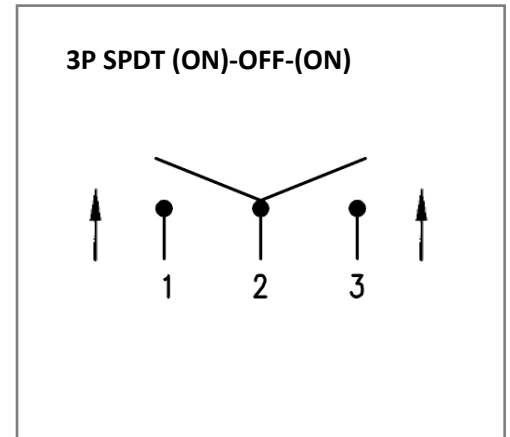

Electrical Specifications

Rating	20A 125V AC 3/4HP, 10A 250V AC 3/4HP 10(4)A 250V AC
Contact Resistance	50m ohm Max
Insulation Resistance	DC 500V 100M ohm Min
Dielectric Strength	AC 1500V 1minute
Operation Temperature	-20°C~85°C

Material Specifications

Frame	Black, Nylon #66
Actuator	Black, Nylon 66+33%GF
Waterproof	IP56

Rev	Date of issue	Revision Notes	Designed	Approved
B	12-01-2021	Initial Drawing	RC	OF