



Preliminary

- Surface Mount 3.0 x 3.0 x 1.3 mm Package
- Complies with Directive 2002/95/EC (RoHS)

RoHS
Compliant

SF2202E-1

2017.5 MHz
SAW Filter

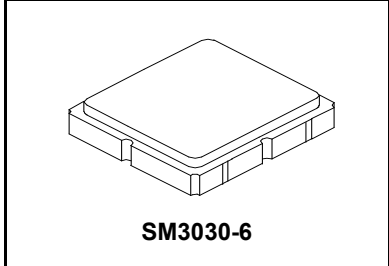

Absolute Maximum Ratings

Rating	Value	Units
Input Power Level	10	dBm
DC Voltage on any Non-ground Terminal	3	V
Operating Temperature Range	-40 to +95	°C
Storage Temperature Range	-40 to +95	°C
Solder Reflow Temperature, 10 seconds, 5 cycles maximum	260	°C

Electrical Characteristics

Characteristic	Sym	Min(-40~95°C)	Typ	Max(-40~85°C)	(-40~95°C)	Units
Center Frequency	F_C		2017.5			MHz
Insertion Loss, 2010 to 2025 MHz	IL		3.1	4.2	4.5	dB
Amplitude Ripple, 2010 to 2025 MHz			0.4	1.4	1.8	dB _{p-p}
VSWR, 2010 to 2025			1.3:1		2.5:1	
Group Delay Ripple, 2010 to 2025 MHz			9	30	30	ns _{p-p}
Attenuation, Referenced to 0 dB						dB
1700 to 1785 MHz		40	50			
1800 to 1860 MHz		45	51			
1920 to 1980 MHz		30	37			
2045 to 2070 MHz		6	33			
2070 to 2085 MHz		15	54			
2170 to 4000 MHz		30	33			
Source Impedance	Z_S		50			Ω
Load Impedance	Z_L		50			
Case Style	SM3030-6 3.0 x 3.0 mm Nominal Footprint					
Lid Symbolization (Y=year, WW=week, S=shift) dot=pin 1 indicator	947, YWWS					
Standard Reel Quantity	Reel Size 7 Inch					500 Pieces/Reel
	Reel Size 13 Inch					3000 Pieces/Reel



CAUTION: Electrostatic Sensitive Device. Observe precautions for handling.

NOTES:

1. The design, manufacturing process, and specifications of this device are subject to change.
2. US or International patents may apply.
3. RoHS compliant from the first date of manufacture.

Filter Response Plots

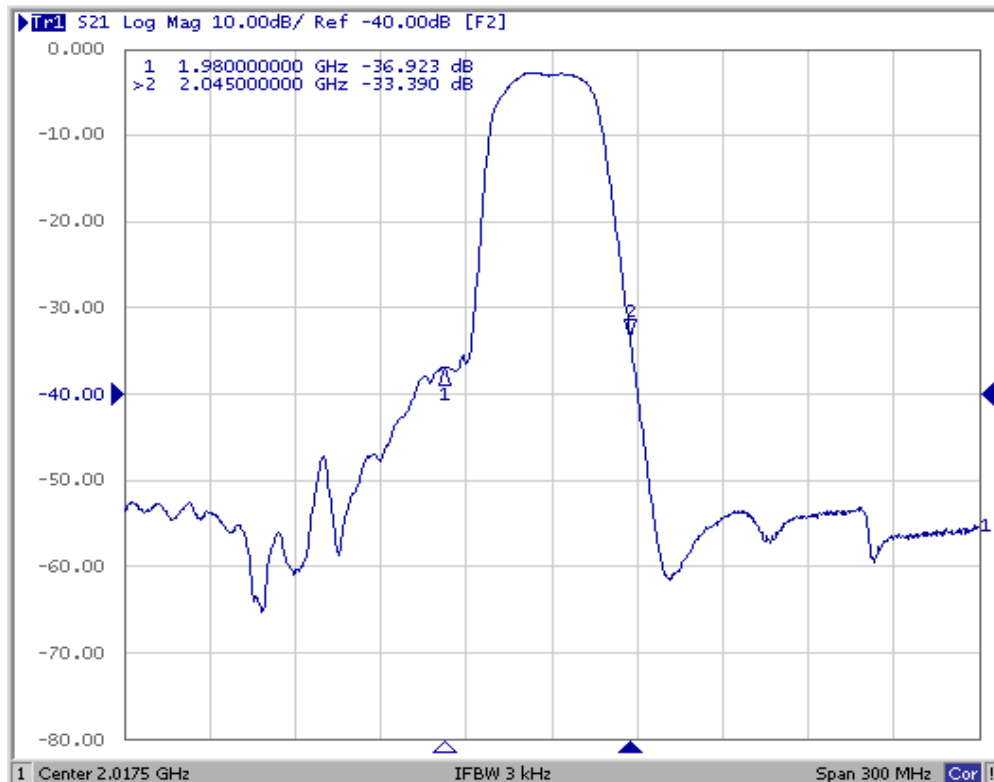
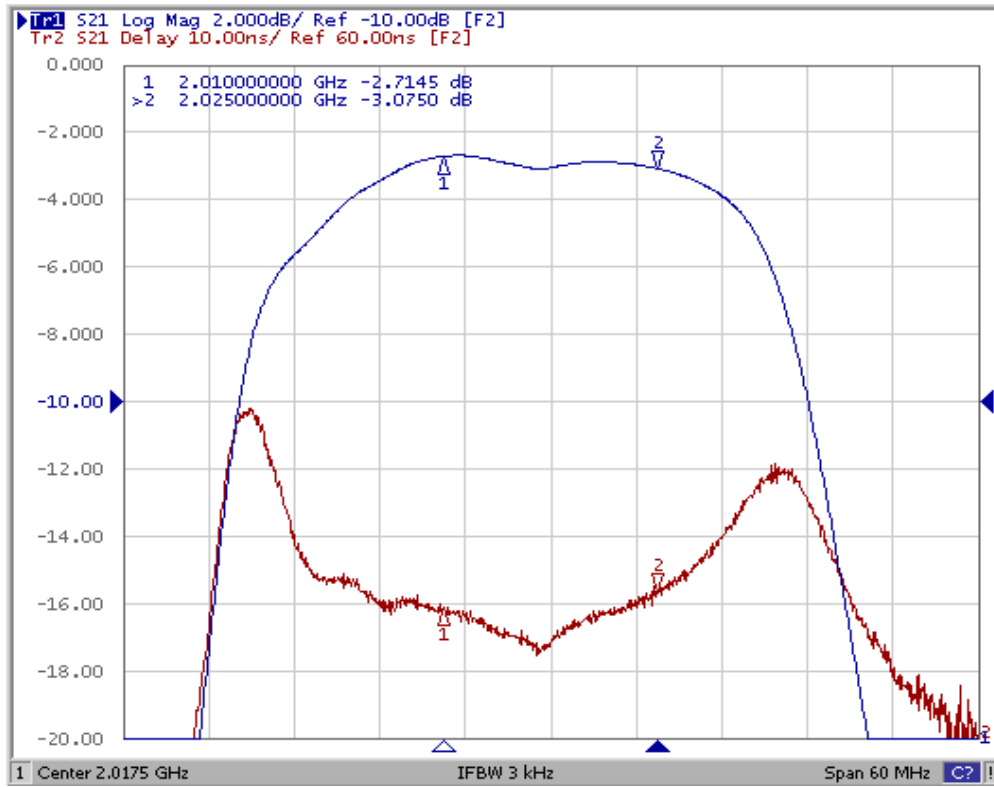

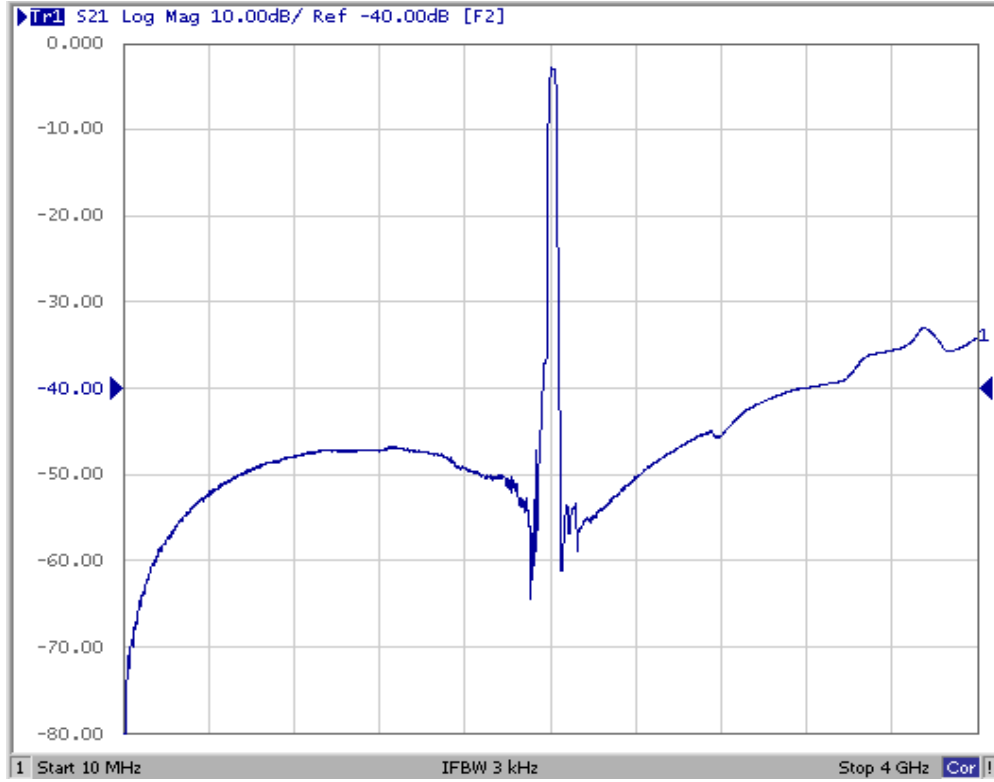

Filter VSWR Plots

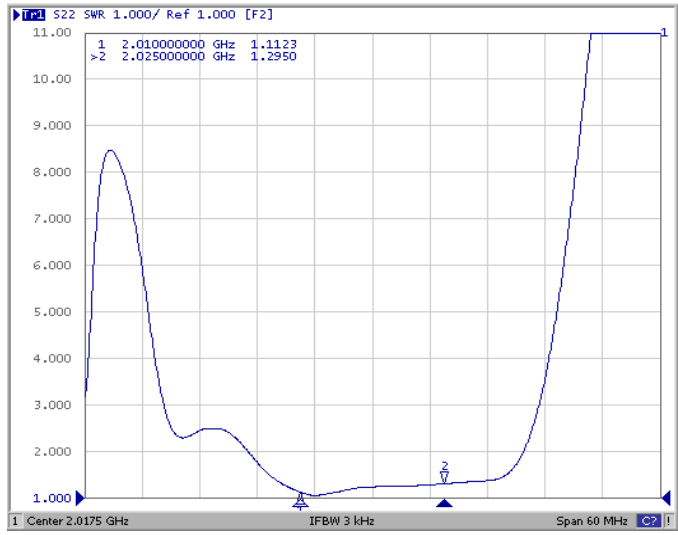
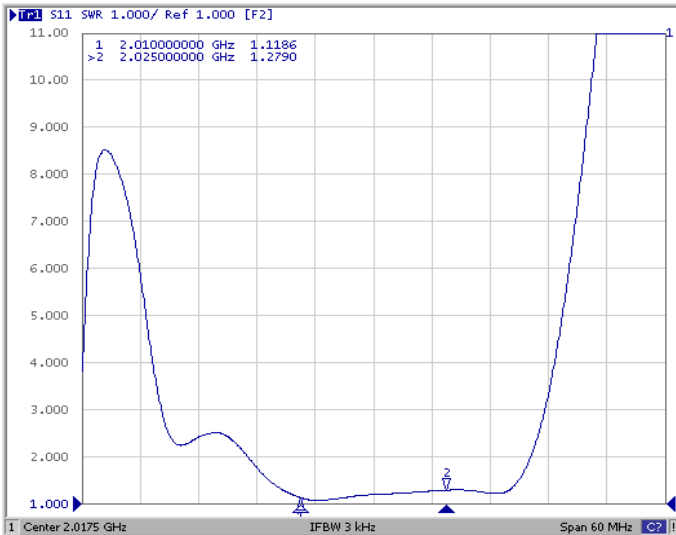

SM3030-6 Case

6-Terminal Ceramic Surface-Mount Case 3.0 X 3.0 mm Nominal Footprint

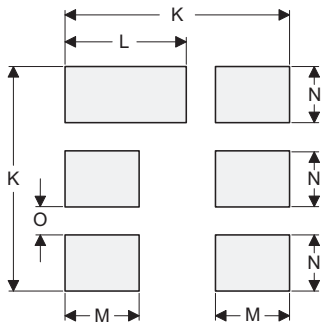
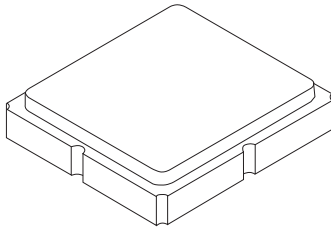

PCB Footprint Top View

Case and PCB Footprint Dimensions

Dimension	mm			Inches		
	Min	Nom	Max	Min	Nom	Max
A	2.87	3.00	3.13	0.113	0.118	0.123
B	2.87	3.00	3.13	0.113	0.118	0.123
C	1.12	1.25	1.38	0.044	0.049	0.054
D	0.77	0.90	1.03	0.030	0.035	0.040
E	2.67	2.80	2.93	0.105	0.110	0.115
F	1.47	1.60	1.73	0.058	0.063	0.068
G	0.72	0.85	0.98	0.028	0.033	0.038
H	1.37	1.50	1.63	0.054	0.059	0.064
I	0.47	0.60	0.73	0.019	0.024	0.029
J	1.17	1.30	1.43	0.046	0.051	0.056
K		3.20			0.126	
L		1.70			0.067	
M		1.05			0.041	
N		0.81			0.032	
O		0.38			0.015	

Case Materials

Materials	
Solder Pad Plating	0.3 to 1.0 μm Gold over 1.27 to 8.89 μm Nickel
Lid Plating	2.0 to 3.0 μm Nickel
Body	Al_2O_3 Ceramic
Pb Free	

Electrical Connections

Connection	Terminals
Input	5
Output	2
Ground	All Others

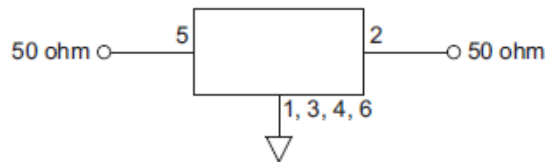

TOP VIEW

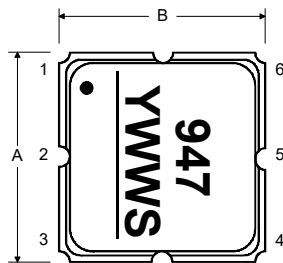

BOTTOM VIEW

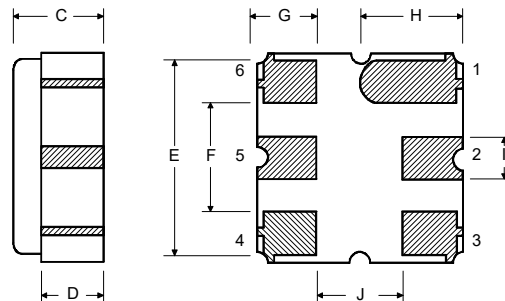

Recommended Reflow Profile

1. Preheating shall be fixed at 150~180°C for 60~90 seconds.
2. Ascending time to preheating temperature 150°C shall be 30 seconds min.
3. Heating shall be fixed at 220°C for 50~80 seconds and at 260°C +0/-5°C peak (10 seconds).
4. Time: 5 times maximum.

