

LAURA-RS

~8° spot beam optimized for CREE XP-E.
Assembly with black holder and installation
tape.

SPECIFICATION:

Dimensions	21.6 x 21.6 mm
Height	13.1 mm
Fastening	tape
ROHS compliant	yes ⓘ



MATERIALS:

Component	Type	Material	Colour	Finish
LAURA-RS	Single lens	PMMA	clear	
LAURA-HLD-XP-BLK	Holder	PC	black	
ROSE-TAPE	Tape	Acrylic foam	black	

ORDERING INFORMATION:

Component		Qty in box	MOQ	MPQ	Box weight (kg)
CA11353_LAURA-RS	Single lens	1440	360	180	7.4
» Box size: 451 x 254 x 152 mm					

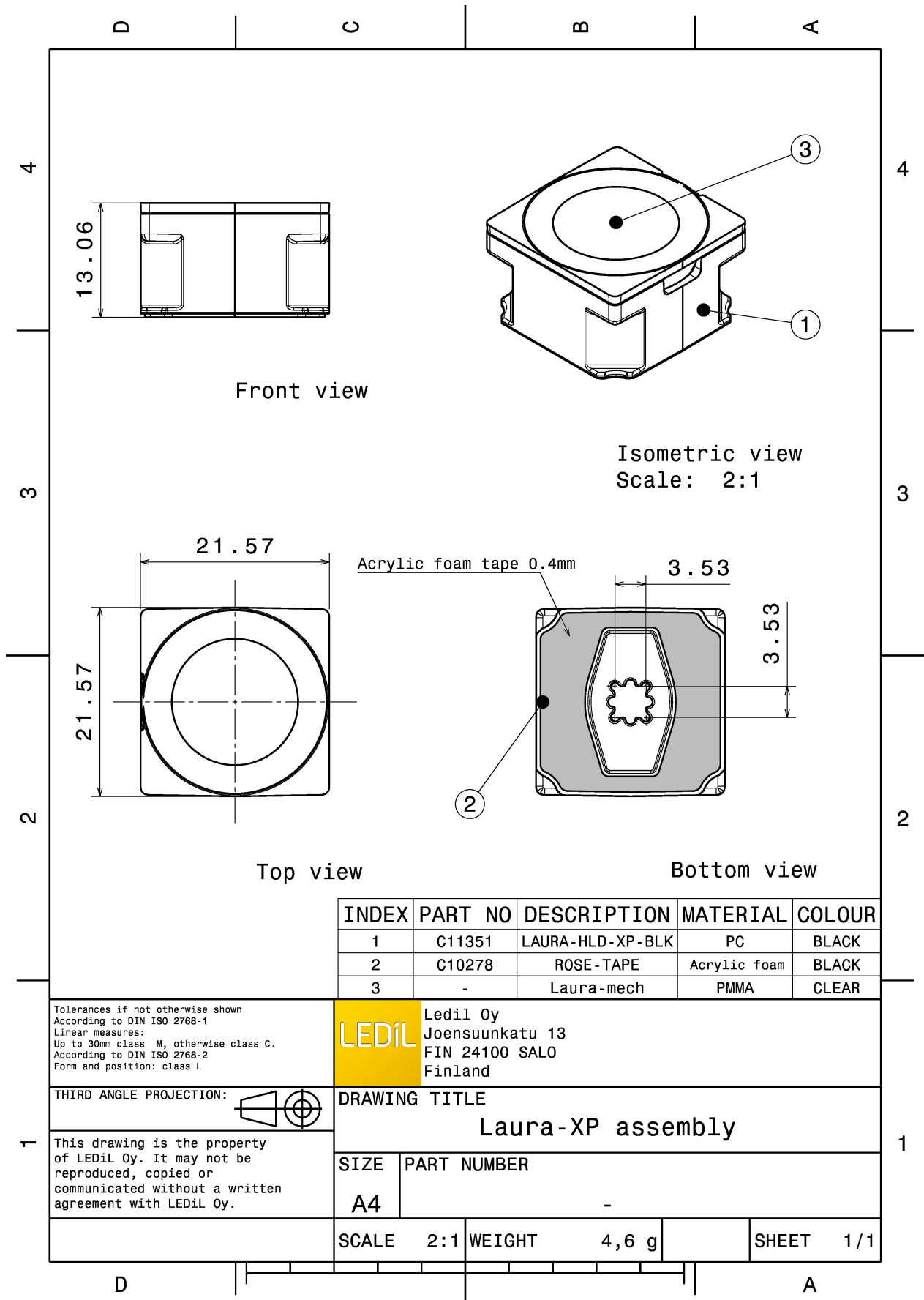

INDEX	PART NO	DESCRIPTION	MATERIAL	COLOUR
1	C11351	LAURA-HLD-XP-BLK	PC	BLACK
2	C10278	ROSE-TAPE	Acrylic foam	BLACK
3	-	Laura-mech	PMMA	CLEAR

Tolerances if not otherwise shown
According to DIN ISO 2768-1
Linear measures:
Up to 30mm class M, otherwise class C.
According to DIN ISO 2768-2
Form and position: class L

LEDiL Ledil Oy
Joensuunkatu 13
FIN 24100 SALO
Finland

THIRD ANGLE PROJECTION:

DRAWING TITLE
Laura-XP assembly

This drawing is the property of LEDiL Oy. It may not be reproduced, copied or communicated without a written agreement with LEDiL Oy.

SIZE	PART NUMBER
A4	-

SCALE	2:1	WEIGHT	4,6 g	SHEET	1/1
-------	-----	--------	-------	-------	-----

See also our general installation guide: www.ledil.com/installation_guide

OPTICAL RESULTS (MEASURED):

CREE LED

LED XP-E
FWHM / FWTM 8.0° / 14.0°
Efficiency 93 %
Peak intensity 41.8 cd/lm
LEDs/each optic 1
Light colour White
Required components:

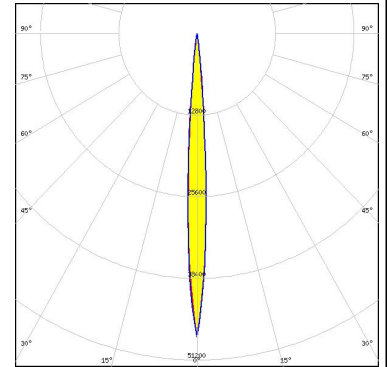

CREE LED

LED XP-G
FWHM / FWTM 10.0° / 19.0°
Efficiency 93 %
Peak intensity 18.6 cd/lm
LEDs/each optic 1
Light colour White
Required components:

CREE LED

LED XP-G2
FWHM / FWTM 10.0° / 18.0°
Efficiency 93 %
Peak intensity 22.7 cd/lm
LEDs/each optic 1
Light colour White
Required components:

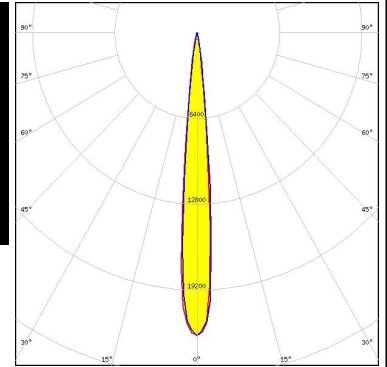

OPTICAL RESULTS (SIMULATED):

CREE LED

LED XD16
 FWHM / FWTM 8.0° / 18.0°
 Efficiency 90 %
 Peak intensity 25.9 cd/lm
 LEDs/each optic 1
 Light colour White
 Required components:

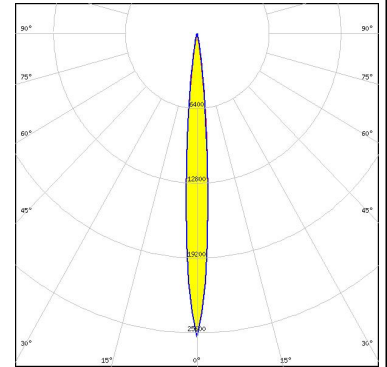

CREE LED

LED XP-E2
 FWHM / FWTM 8.0° / 16.0°
 Efficiency 92 %
 Peak intensity 38.8 cd/lm
 LEDs/each optic 1
 Light colour White
 Required components:

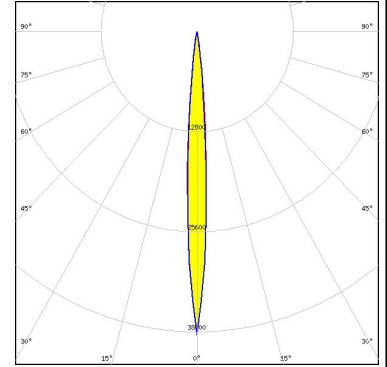

CREE LED

LED XP-G3
 FWHM / FWTM 12.0° / 24.0°
 Efficiency 84 %
 Peak intensity 14.4 cd/lm
 LEDs/each optic 1
 Light colour White
 Required components:

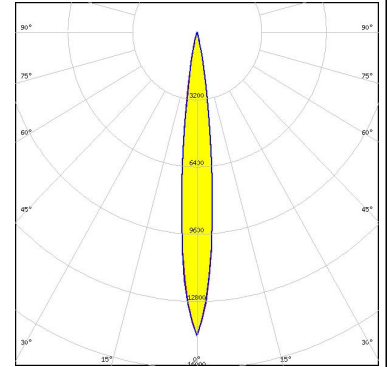

LUMILEDS

LED LUXEON HL2X
 FWHM / FWTM 12.0° / 24.0°
 Efficiency 92 %
 Peak intensity 15.7 cd/lm
 LEDs/each optic 1
 Light colour White
 Required components:

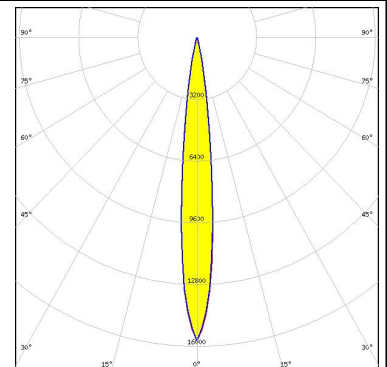

OPTICAL RESULTS (SIMULATED):



LED SST-20
FWHM / FWTM 10.0° / 18.0°
Efficiency 93 %
Peak intensity 26.9 cd/lm
LEDs/each optic 1
Light colour White
Required components:

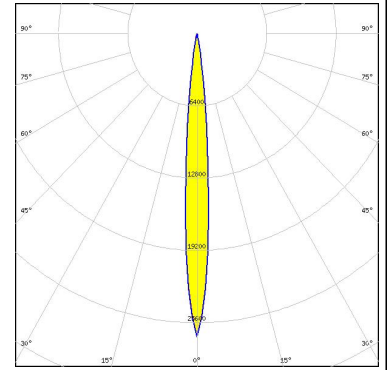

LED OSLOM Square CSSRM2/CSSRM3
FWHM / FWTM 10.0° / 19.0°
Efficiency 93 %
Peak intensity 23.3 cd/lm
LEDs/each optic 1
Light colour White
Required components:

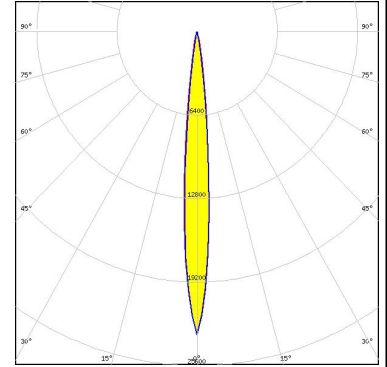

LED OSLOM SSL 80
FWHM / FWTM 8.0° / 16.0°
Efficiency 92 %
Peak intensity 34.4 cd/lm
LEDs/each optic 1
Light colour White
Required components:

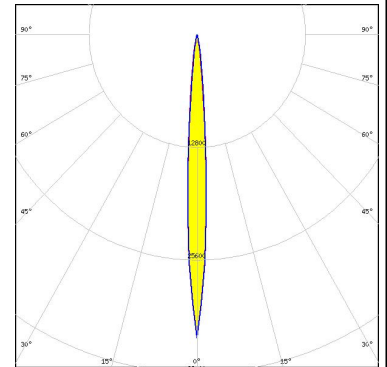

LED LH351C
FWHM / FWTM 12.0° / 22.0°
Efficiency 82 %
Peak intensity 14.5 cd/lm
LEDs/each optic 1
Light colour White
Required components:

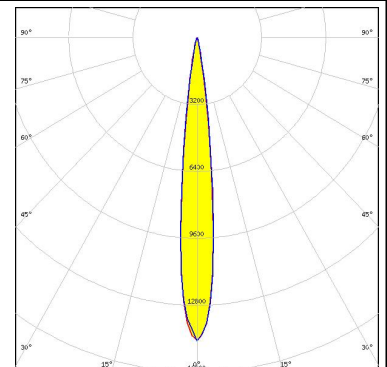

OPTICAL RESULTS (SIMULATED):

 SEOUL SEMICONDUCTOR	
LED	Z5
FWHM / FWTM	8.0°
Efficiency	%
LEDs/each optic	1
Light colour	White
Required components:	
 SEOUL SEMICONDUCTOR	
LED	Z5M4
FWHM / FWTM	13.0° / 25.0°
Efficiency	93 %
Peak intensity	13.7 cd/lm
LEDs/each optic	1
Light colour	White
Required components:	



GENERAL INFORMATION:

NOTE: The typical beam angle will be changed by different color, chip size and chip position tolerance. The typical total beam angle is the full angle measured where the luminous intensity is half of the peak value.

MATERIALS:

As part of our continuous research and improvement processes, and to ensure the best possible quality and availability of our products, LEDiL reserves the right to change material grades without notice.

PRODUCT DATA USER AGREEMENT AND DISCLAIMER:

The measured data in the provided downloadable LEDiL Product Datasheets and Mechanical 2D-Drawings is rounded and provided as reference for planning. LEDiL Oy's optical specifications have been verified by conducting performance testing of the products in accordance with the company's quality system. The reported data are averaged results of multiple measurements with typical variation. LEDiL Oy reserves the right to without prior notification make changes and improvements to its products.

LEDiL Oy assumes neither warranty, nor guarantee nor any other liability of any kind for the contents and correctness of the provided data. The provided data has been generated with highest diligence but the provided data may in reality not represent the complete possible variation range of all intrinsic parameters. Therefore, in certain cases a deviation from the provided data could occur.

LEDiL Oy reserves the right to undertake technical changes of its products without further notification which could lead to changes in the provided data. LEDiL Oy assumes no liability of any kind for the possible deviation from any provided data or any other damage resulting from the usage of the provided data.

The user agrees to this disclaimer and user agreement with the download or usage of the provided files.

LEDiL Oy

Joensuunkatu 13
FI-24240 SALO
Finland

LEDiL Inc.

228 West Page Street
Suite D
Sycamore IL 60178
USA

Ledil Optics Technology (Shenzhen) Co., Ltd.

405 , Block B
Casic Motor Building
Shenzhen 518057
P.R.CHINA

Local sales and technical support

[www.ledil.com/
where_to_buy](http://www.ledil.com/where_to_buy)

Shipping locations

Salo, Finland
Hong Kong, China

Distribution Partners

[www.ledil.com/
where_to_buy](http://www.ledil.com/where_to_buy)