

APPROVED: \_\_\_\_\_  
 DATE: \_\_\_\_\_ TITLE: \_\_\_\_\_

Rev	AWO #	Description	Date	Appr
-		RELEASED	1/26/21	
A		ADDED SPEC.	6/21/21	WX/RC

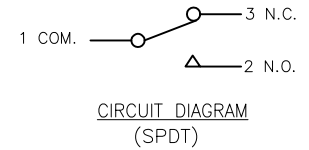
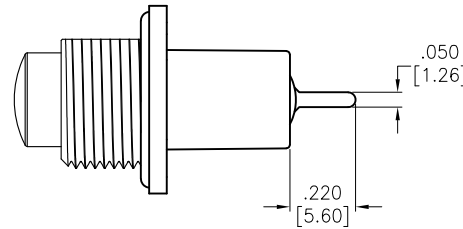
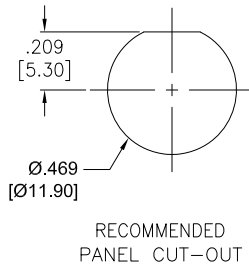
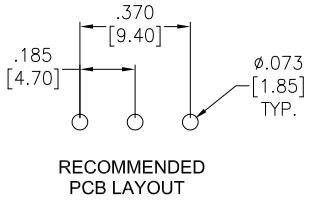
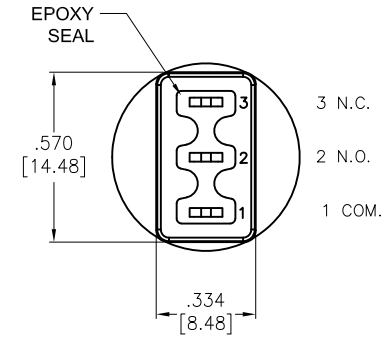
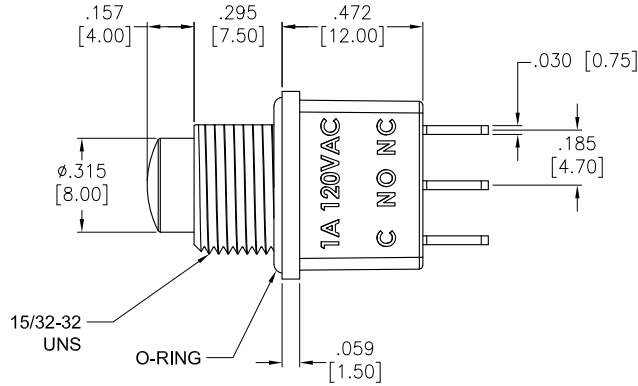
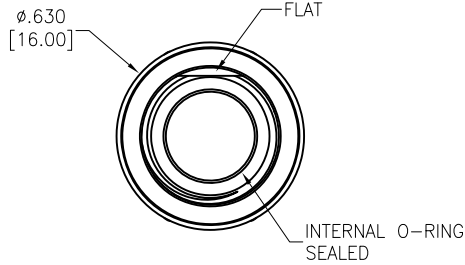

**SPECIFICATIONS:**

Material:  
 Case: DAP, Rated UL94V-0  
 Plunger: Brass, color Black w/ O-Ring  
 Bushing: Brass, color Black w/ O-Ring  
 Movable Contact: Copper Alloy, Silver Plated  
 Terminal: Copper Alloy, Silver Plated  
 Electrical:  
 Rating: 1A @ 120VAC or 38V DC  
 Contact resistance: 10 mΩ max  
 Insulation resistance: 1,000 Mohms min  
 Dielectric withstanding voltage: 1,500V RMS @Sea level  
 Life: 50,000 cycles at full load  
 Temperature Rating:  
 Operating temperature: -30°C to +85°C

Environmental:  
 Sealed IP68 Rated  
 Lead free, RoHS compliant

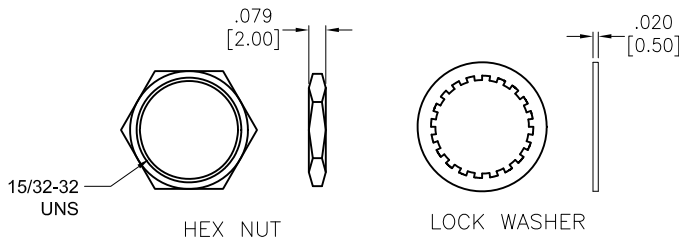

BUTTON POSITION		
FUNCTION	ON	MOM
TERMINALS	1-3	1-2

UNLESS OTHERWISE SPECIFIED  
 ALL DIMENSIONS ARE INCHES [MM]  
 TOLERANCES: EXCEPT AS NOTED

INCHES	HOLES
.X ± .10	Ø.X ± .10
.XX ± .020	Ø.XX ± .015
.XXX ± .015	Ø.XXX ± .010



909 Rahway Avenue,  
 Union, NJ 07083  
 Phone: 908-687-5000  
 Fax: 908-687-5710

TITLE  
 HIGH PERFORMANCE PUSH BUTTON SWITCH,  
 SPDT, ON-MOM, SILVER PLATED, PCB TAILS

APPROVALS		DATE
DRAWN	LH	1/26/21
CHECKED	AC	1/26/21
APPROVED		

SIZE	PART NO.	REV.
X	SW-PB10-CBB2QE-4	A
REF:	S00198T	SCALE: NTS SHEET 1 OF 1