

## ACMSP3415-HF

**P-Channel**  
**RoHS Device**  
**Halogen Free**

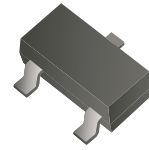

### Features

- Electrostatic sensitive devices.
- High-speed switching.
- Drive circuits can be simple.
- Parallel use is easy.
- ESD protection up to 2kV(Human body mode).
- AEC-Q101 Qualified.

### Mechanical data

- Case: SOT-23, molded plastic.
- Molding compound: UL flammability classification rating 94V-0.
- Terminals: Matte tin plated leads, solderable per MIL-STD-202, method 208.

### Circuit Diagram

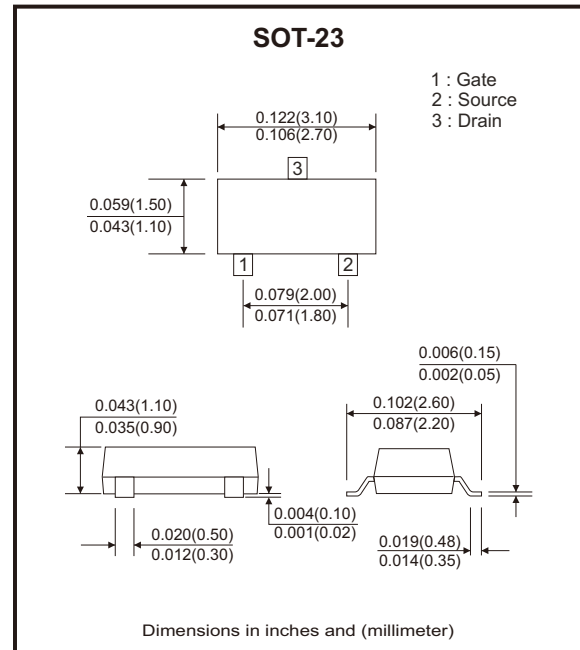
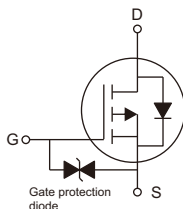

### Maximum Ratings (at $T_A=25^\circ\text{C}$ unless otherwise noted)

Parameter	Symbol	Value	Unit
Drain-source voltage	$V_{DSS}$	-20	V
Gate-source voltage	$V_{GSS}$	$\pm 10$	V
Continuous drain current ( $T_A = 25^\circ\text{C}$ )	$I_D$	-4	A
Continuous drain current ( $T_A = 70^\circ\text{C}$ )	$I_D$	-3.5	
Pulsed drain current (Note 1)	$I_{DM}$	-16	A
Power dissipation ( $T_A = 25^\circ\text{C}$ )	$P_D$	1.4	W
Power dissipation ( $T_A = 70^\circ\text{C}$ )	$P_D$	0.9	
Thermal resistance junction to ambient air	$R_{\theta JA}$	90	$^\circ\text{C}/\text{W}$
Operating junction temperature range	$T_J$	-55 to +150	$^\circ\text{C}$
Storage temperature range	$T_{STG}$	-55 to +150	$^\circ\text{C}$

Notes: 1. 10 $\mu\text{s}$  pulse, duty cycle = 1%, repetitive rating pulse width limited by junction temperature.

## Electrical Characteristics (at Ta=25°C unless otherwise noted)

Parameter	Symbol	Conditions	Min	Typ	Max	Unit
<b>Static Characteristics</b>						
Drain-source breakdown voltage	$V_{DSS}$	$V_{GS} = 0V, I_D = -250\mu A$	-20			V
Zero gate voltage drain current	$I_{DSS}$	$V_{DS} = -20V, V_{GS} = 0V$			-1	$\mu A$
Gate-body leakage current	$I_{GSS}$	$V_{GS} = \pm 10V, V_{DS} = 0V$			$\pm 10$	$\mu A$
<b>On Characteristics (Note 2)</b>						
Static drain-source on resistance	$R_{DS(ON)}$	$V_{GS} = -4.5V, I_D = -4A$		40	50	m $\Omega$
		$V_{GS} = -2.5V, I_D = -4A$		55	70	
		$V_{GS} = -1.8V, I_D = -2A$		78	100	
Gate threshold voltage	$V_{GS(th)}$	$V_{DS} = V_{GS}, I_D = -250\mu A$	-0.45	-0.75	-1	V
Forward transconductance	$g_{FS}$	$V_{DS} = -5V, I_D = -4A$	8	12		S
<b>Dynamic Characteristics (Note 2)</b>						
Input capacitance	$C_{iss}$	$V_{GS} = 0V, V_{DS} = -10V, f = 1MHz$		1600		pF
Output capacitance	$C_{oss}$			115		
Reverse transfer capacitance	$C_{rss}$			101		
Gate resistance	$R_G$	$f = 1MHz$		35		$\Omega$
<b>Switching Characteristics (Note 2)</b>						
Total gate charge	$Q_g$	$V_{DD} = -10V, V_{GS} = -4.5V, I_D = 4A$		11		nC
Gate-source charge	$Q_{gs}$			1.9		
Gate-drain charge	$Q_{gd}$			2.6		
<b>Source-Drain Diode Characteristics</b>						
Diode forward voltage (Note 1)	$V_{SD}$	$I_S = -1A, V_{GS} = 0V$		-0.8	-1	V
Diode continuous forward current	$I_S$	$T_C = 25^\circ C$			-4	A

Notes: 1. 10 $\mu s$  pulse, duty cycle = 1%, repetitive rating pulse width limited by junction temperature.

2. Guaranteed by design, not subject to production.

## Rating and Characteristic Curves (ACMSP3415-HF)

Fig.1 - On-Region Characteristics

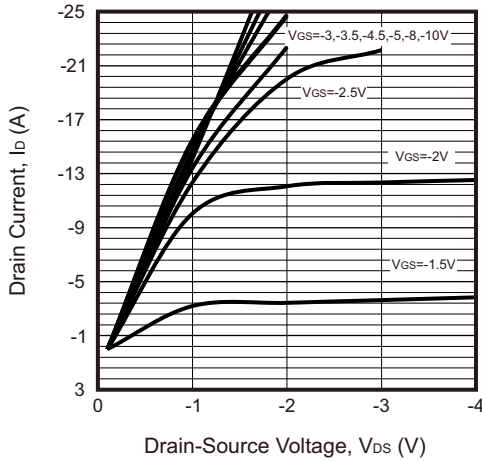

Fig.2 - On-Resistance vs. Drain Current and Gate Voltage

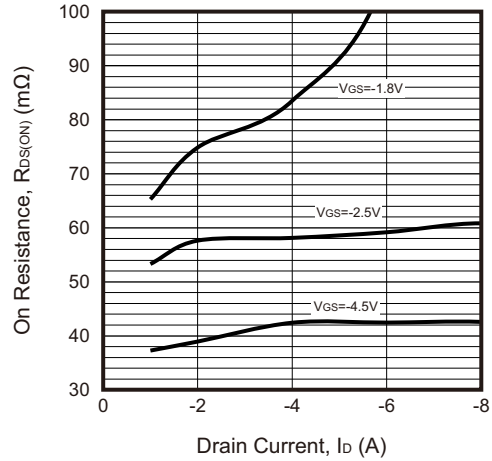

Fig.3 - On-Resistance vs. Gate-Source Voltage

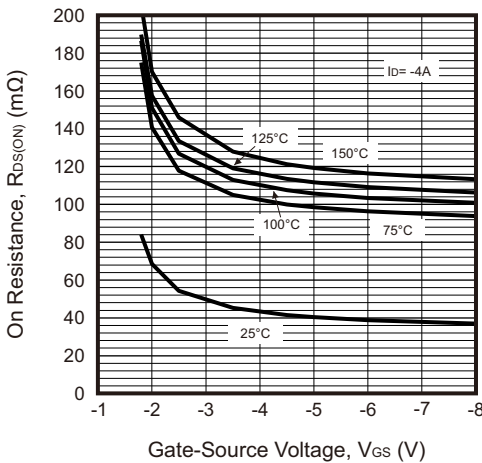

Fig.4 - Body-Diode Characteristics

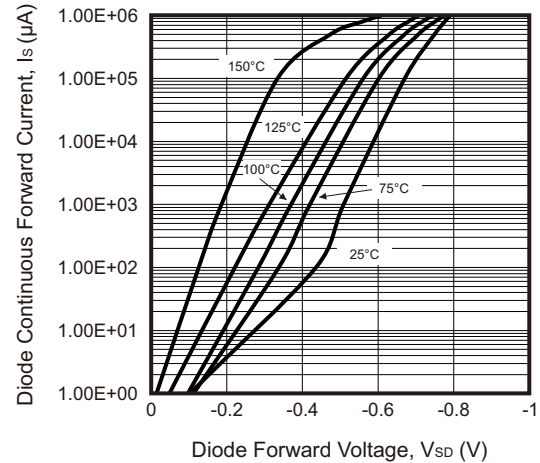

Fig.5 - On-Resistance vs. Junction Temperature

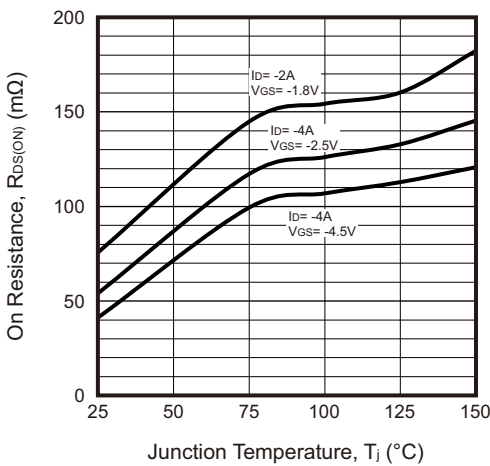
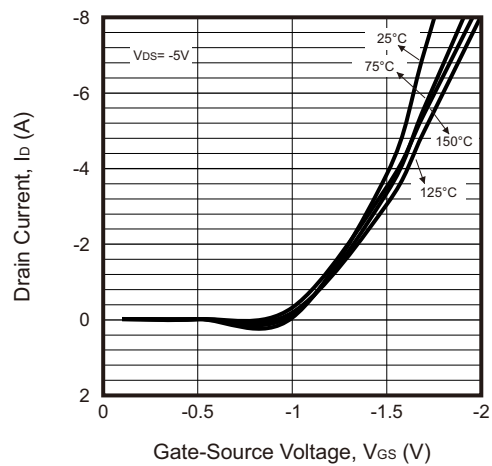
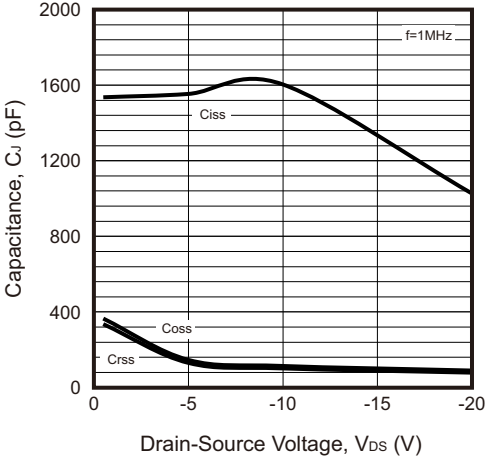

Fig.6 - Transfer Characteristics



Rating and Characteristic Curves (ACMSP3415-HF)

Fig.7 - Capacitance Characteristics



Reel Taping Specification

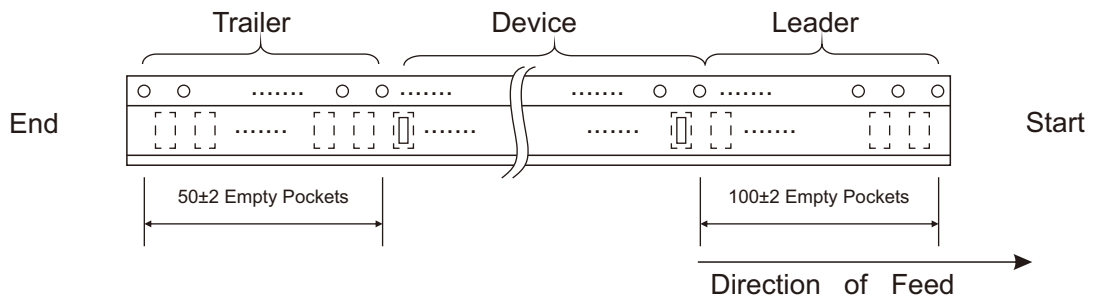
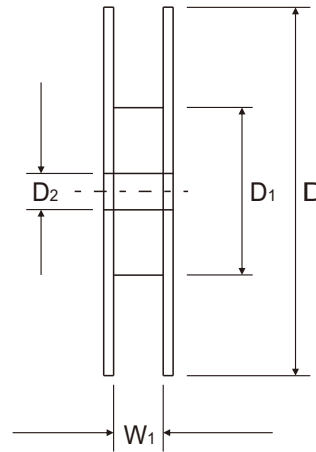
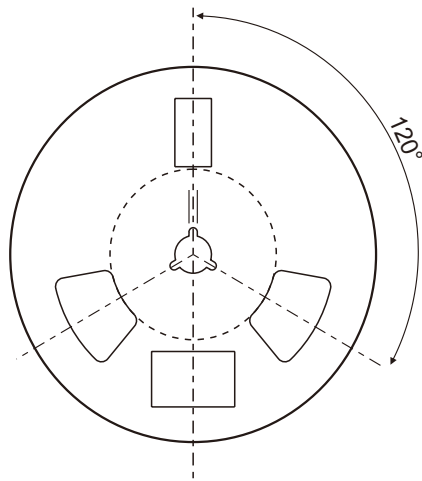
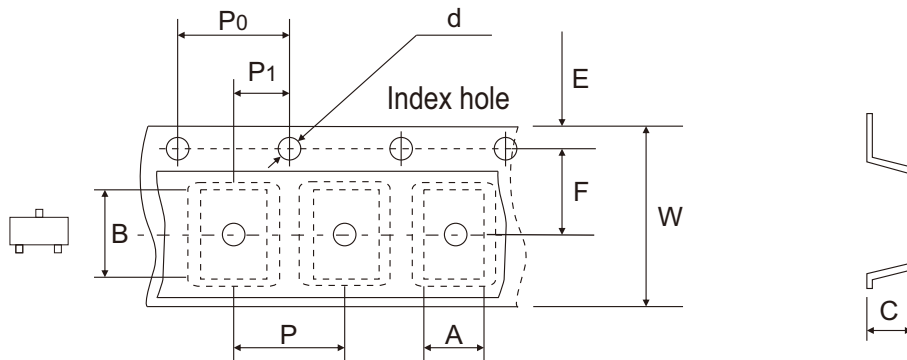

SOT-23	SYMBOL	A	B	C	d	D	D1	D2
	(mm)	3.15 ± 0.10	2.77 ± 0.10	1.22 ± 0.10	1.50 ± 0.10	178.00 ± 1.00	54.00 ± 0.50	13.00 ± 0.50
	(inch)	0.124 ± 0.004	0.109 ± 0.004	0.048 ± 0.004	0.059 ± 0.004	7.008 ± 0.039	2.126 ± 0.020	0.512 ± 0.020

SOT-23	SYMBOL	E	F	P	P0	P1	W	W1
	(mm)	1.75 ± 0.10	3.50 ± 0.05	4.00 ± 0.10	4.00 ± 0.10	2.00 ± 0.05	8.00 + 0.30 - 0.10	9.50 ± 1.00
	(inch)	0.069 ± 0.004	0.138 ± 0.002	0.157 ± 0.004	0.157 ± 0.004	0.079 ± 0.002	0.315 + 0.012 - 0.004	0.374 ± 0.039

## Marking Code

Part Number	Marking Code
ACMSP3415-HF	3415E

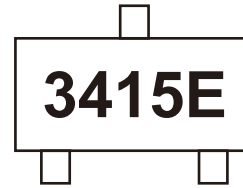

## Suggested P.C.B. PAD Layout

SIZE	SOT-23	
	(mm)	(inch)
A	0.90	0.035
B	0.80	0.031
C	0.95	0.037
D	2.00	0.079
E	2.90	0.114

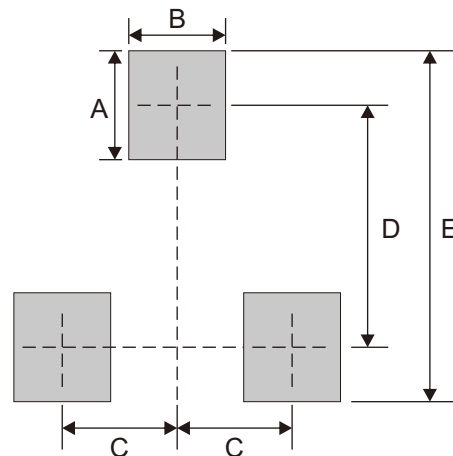

## Standard Packaging

Case Type	REEL PACK	
	REEL (pcs)	Reel Size (inch)
SOT-23	3,000	7