

## MIRELLA-G2-W

~35° wide beam. Compatible with LEDiL HEKLA.

### TECHNICAL SPECIFICATIONS:

Dimensions	Ø 49.9 mm
Height	22.6 mm
Fastening	socket
ROHS compliant	yes ⓘ

### MATERIAL SPECIFICATIONS:

Component	Type	Material	Colour	Finish	Coating
MIRELLA-G2-W	Reflector	PC	metal		

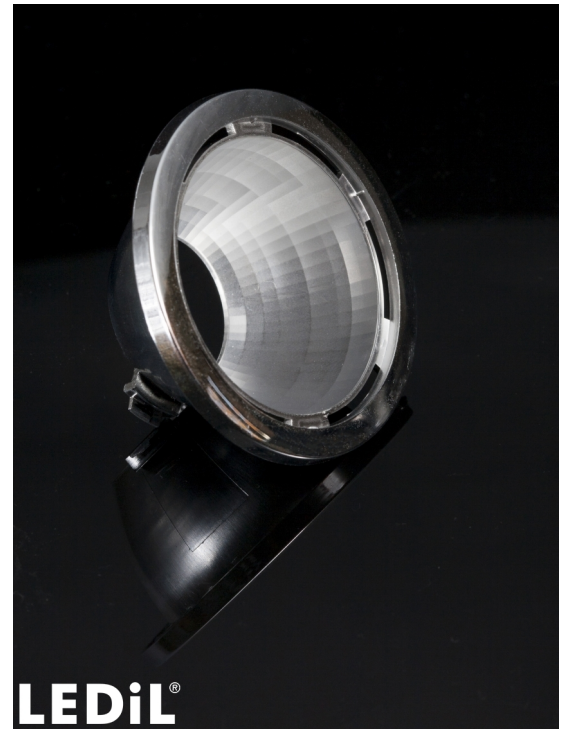





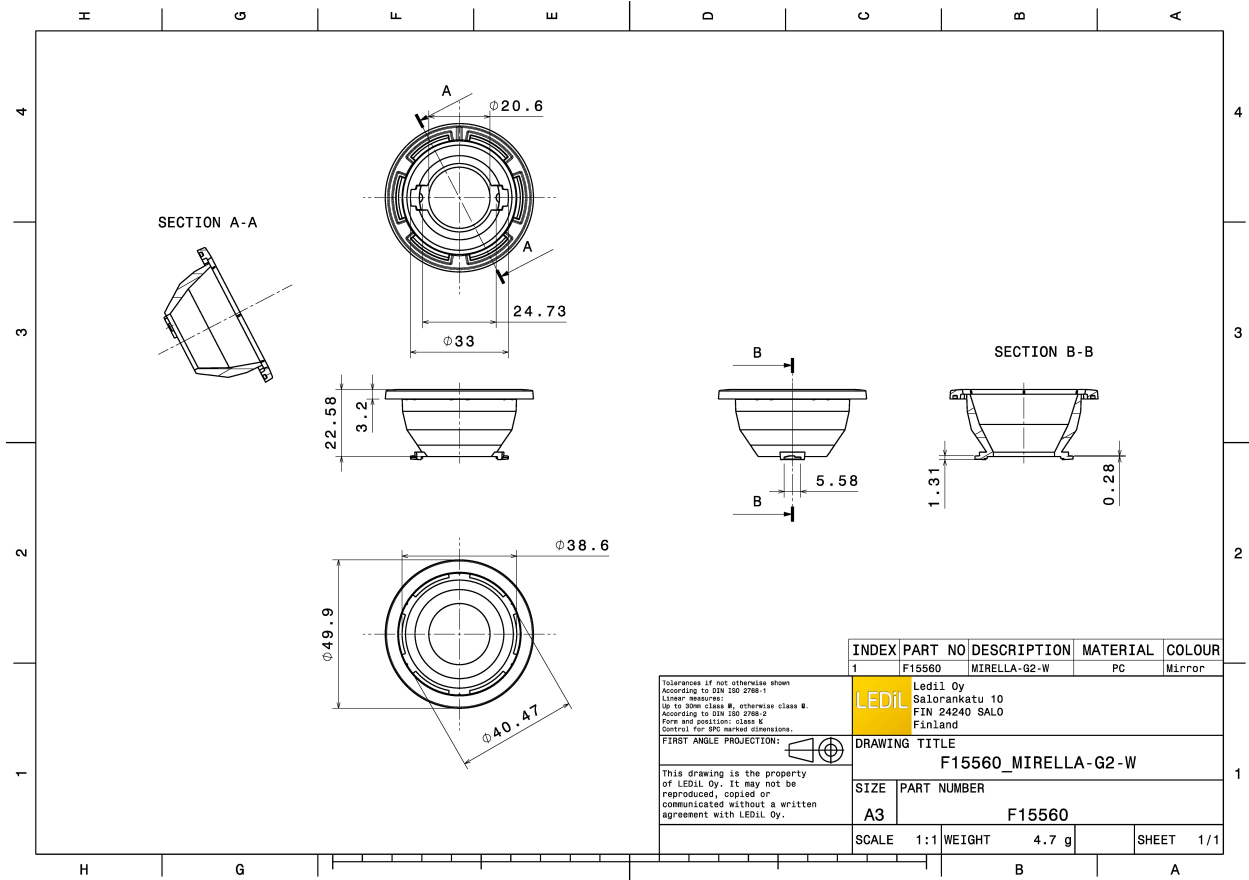

### ORDERING INFORMATION:

Component	Qty in box	MOQ	MPQ	Box weight (kg)
F15560_MIRELLA-G2-W » Box size: 480 x 280 x 300 mm	336		28	3.3

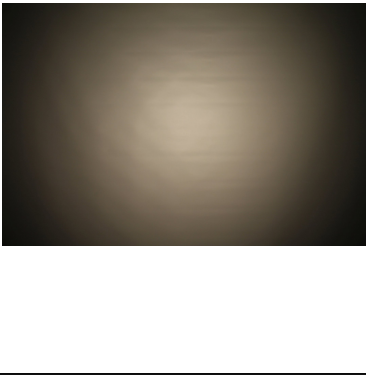
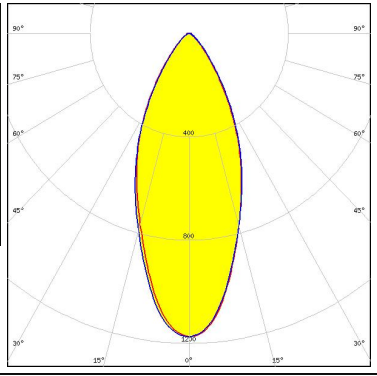

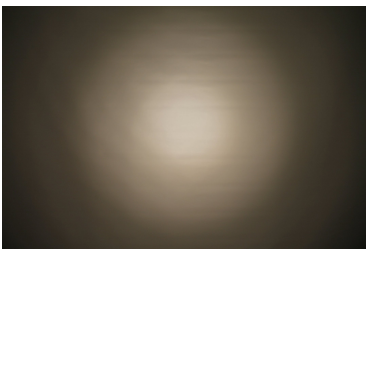
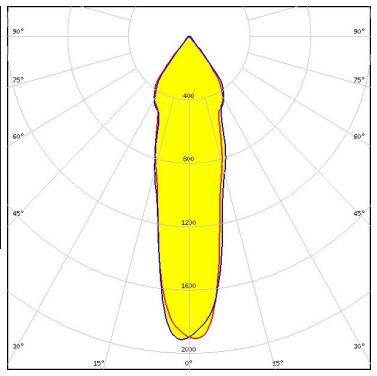

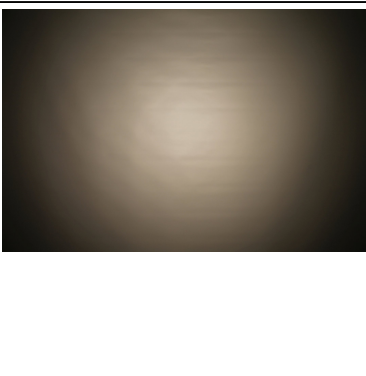
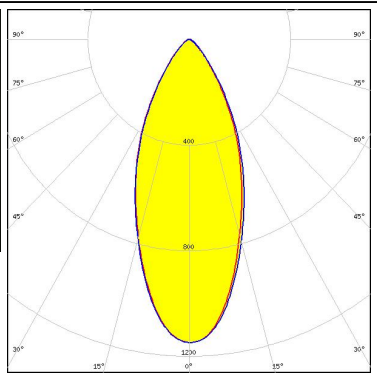

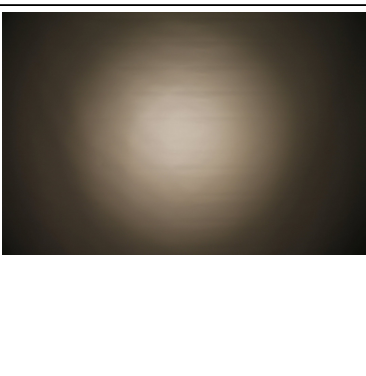
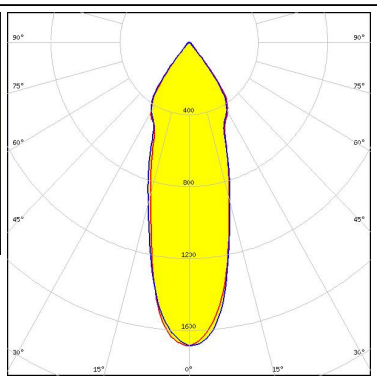

See also our general installation guide: [www.ledil.com/installation\\_guide](http://www.ledil.com/installation_guide)

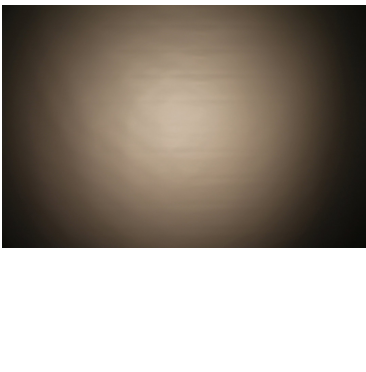
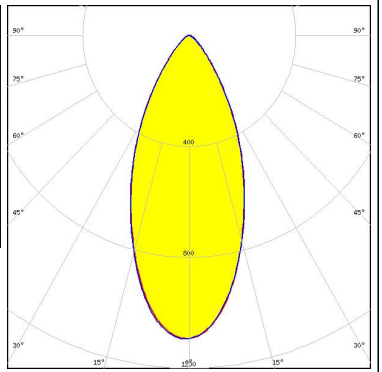

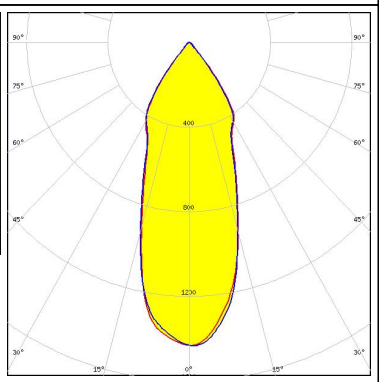

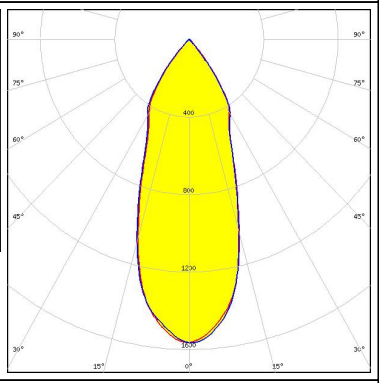

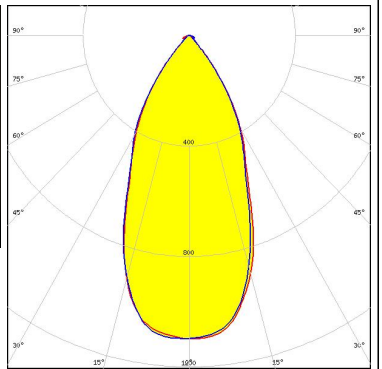

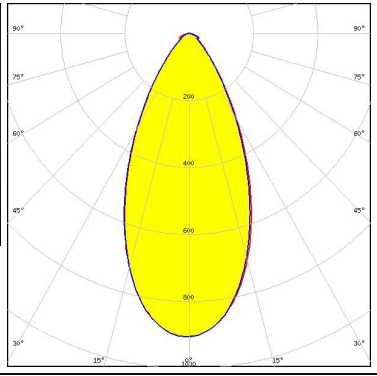

#### PHOTOMETRIC DATA (MEASURED):

<p></p> <p>LED V4 HD            FWHM / FWTM 42.0° / 83.0°            Efficiency 80 %            Peak intensity 1.2 cd/lm            LEDs/each optic 1            Light colour White</p> <p>Required components:            F15253_HEKLA-SOCKET-A            C13723_MIRELLA-RZL</p>		
<p></p> <p>LED V4 HD            FWHM / FWTM 26.0° / 78.0°            Efficiency 89 %            Peak intensity 1.9 cd/lm            LEDs/each optic 1            Light colour White</p> <p>Required components:            F15253_HEKLA-SOCKET-A</p>		
<p></p> <p>LED V6 HD            FWHM / FWTM 43.0° / 83.0°            Efficiency 80 %            Peak intensity 1.2 cd/lm            LEDs/each optic 1            Light colour White</p> <p>Required components:            F15255_HEKLA-SOCKET-C            C13723_MIRELLA-RZL</p>		
<p></p> <p>LED V6 HD            FWHM / FWTM 32.0° / 79.0°            Efficiency 88 %            Peak intensity 1.7 cd/lm            LEDs/each optic 1            Light colour White</p> <p>Required components:            F15255_HEKLA-SOCKET-C</p>		

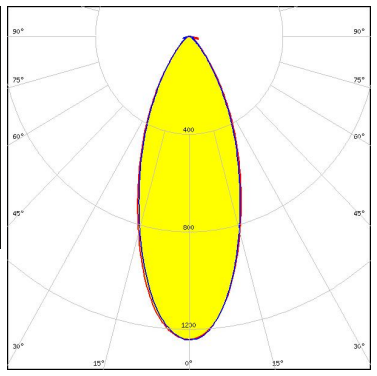

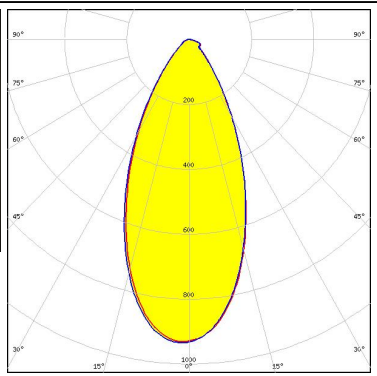

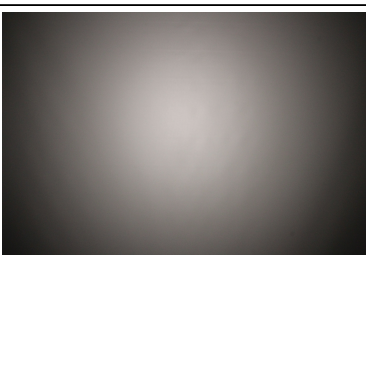

#### PHOTOMETRIC DATA (MEASURED):

<p></p> <p>LED V9 HD            FWHM / FWTM 45.0° / 84.0°            Efficiency 79 %            Peak intensity 1.1 cd/lm            LEDs/each optic 1            Light colour White            Required components:            F15859_HEKLA-SOCKET-I            C13723_MIRELLA-RZL</p>		
<p></p> <p>LED V9 HD            FWHM / FWTM 37.0° / 80.0°            Efficiency 87 %            Peak intensity 1.4 cd/lm            LEDs/each optic 1            Light colour White            Required components:            F15859_HEKLA-SOCKET-I</p>		
<p></p> <p>LED VERO10            FWHM / FWTM 38.0° / 79.0°            Efficiency 91 %            Peak intensity 1.6 cd/lm            LEDs/each optic 1            Light colour White            Required components:            F15616_HEKLA-SOCKET-F</p>		
<p></p> <p>LED Vesta DTW 13mm (21W)            FWHM / FWTM 47.0° / 83.0°            Efficiency 84 %            Peak intensity 1.1 cd/lm            LEDs/each optic 1            Light colour Tunable White            Required components:            C16142_HEKLA-SOCKET-K            Bender Wirth: 491 Typ L8</p>		

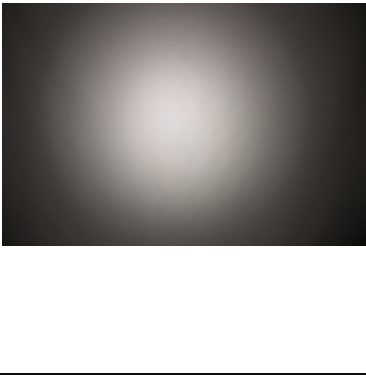
#### PHOTOMETRIC DATA (MEASURED):

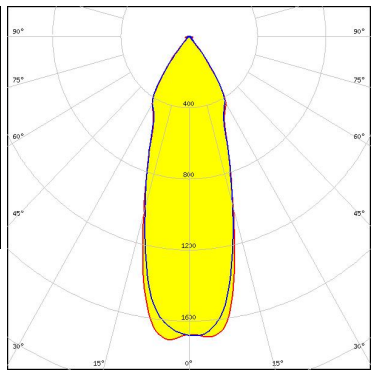
<p></p> <p>LED Vesta DTW 13mm (21W)            FWHM / FWTM 49.0° / 88.0°            Efficiency 75 %            Peak intensity 0.9 cd/lm            LEDs/each optic 1            Light colour Tunable White</p> <p>Required components:            C16142_HEKLA-SOCKET-K            C13723_MIRELLA-RZL            Bender Wirth: 491 Typ L8</p>		
<p></p> <p>LED Vesta DTW 9mm (4W/6W/12W)            FWHM / FWTM 41.0° / 79.0°            Efficiency 80 %            Peak intensity 1.2 cd/lm            LEDs/each optic 1            Light colour White</p> <p>Required components:            C16142_HEKLA-SOCKET-K            C13723_MIRELLA-RZL            Bender Wirth: 492 Typ L8</p>		
<p></p> <p>LED Vesta TW 13mm (25W) CSP            FWHM / FWTM 47.0° / 86.0°            Efficiency 75 %            Peak intensity 0.9 cd/lm            LEDs/each optic 1            Light colour White</p> <p>Required components:            C16142_HEKLA-SOCKET-K            C13723_MIRELLA-RZL            Bender Wirth: 492 Typ L8</p>		
<p></p> <p>LED Vesta TW 6mm DP            FWHM / FWTM 41.0° / 81.0°            Efficiency 75 %            Peak intensity 1.1 cd/lm            LEDs/each optic 1            Light colour White</p> <p>Required components:            C16142_HEKLA-SOCKET-K            C13723_MIRELLA-RZL            Bender Wirth: 504 Typ L8</p>		

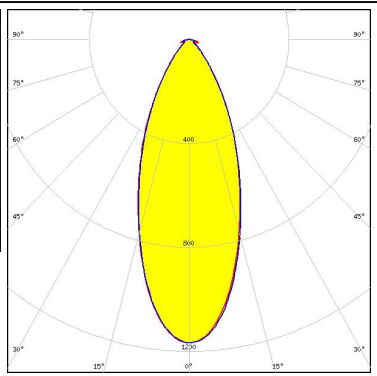
#### PHOTOMETRIC DATA (MEASURED):

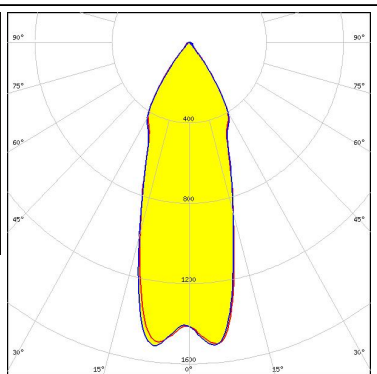
<p></p> <p>LED Vesta TW 6mm DP</p> <p>FWHM / FWTM 29.0° / 75.0°</p> <p>Efficiency 83 %</p> <p>Peak intensity 1.8 cd/lm</p> <p>LEDs/each optic 1</p> <p>Light colour White</p> <p>Required components: C16142_HEKLA-SOCKET-K Bender Wirth: 504 Typ L8</p>		
<p></p> <p>LED Vesta TW 9mm (12W) CSP</p> <p>FWHM / FWTM 34.0° / 76.0°</p> <p>Efficiency 88 %</p> <p>Peak intensity 1.7 cd/lm</p> <p>LEDs/each optic 1</p> <p>Light colour White</p> <p>Required components: C16142_HEKLA-SOCKET-K Bender Wirth: 490 Typ L8</p>		
<p></p> <p>LED Vesta TW 9mm (12W) CSP</p> <p>FWHM / FWTM 40.0° / 80.0°</p> <p>Efficiency 78 %</p> <p>Peak intensity 1.2 cd/lm</p> <p>LEDs/each optic 1</p> <p>Light colour White</p> <p>Required components: C16142_HEKLA-SOCKET-K C13723_MIRELLA-RZL Bender Wirth: 489 Typ L8</p>		
<p><b>CITIZEN</b></p> <p>LED CLC020 Series (Dim-To-Warm)</p> <p>FWHM / FWTM 36.0° / 76.0°</p> <p>Efficiency 85 %</p> <p>Peak intensity 1.6 cd/lm</p> <p>LEDs/each optic 1</p> <p>Light colour White</p> <p>Required components: C16142_HEKLA-SOCKET-K</p>		

#### PHOTOMETRIC DATA (MEASURED):

#### CITIZEN

LED CLC020 Series (Dim-To-Warm)  
 FWHM / FWTM 42.0° / 81.0°  
 Efficiency 77 %  
 Peak intensity 1.1 cd/lm  
 LEDs/each optic 1  
 Light colour White  
 Required components:  
 C16142\_HEKLA-SOCKET-K  
 C13723\_MIRELLA-RZL  
 Bender Wirth: 487 Typ L8

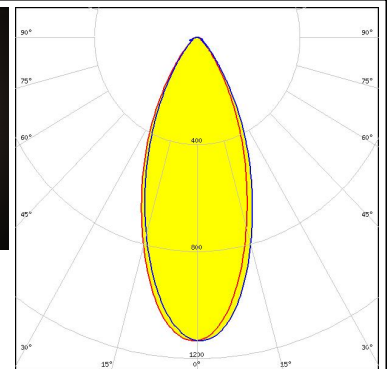
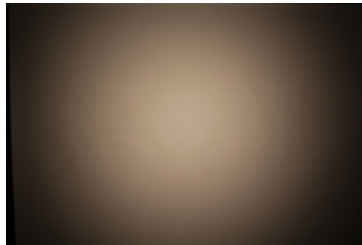

#### CITIZEN

LED CLU025/CLU027 (LES 6)  
 FWHM / FWTM 31.0° / 77.0°  
 Efficiency 90 %  
 Peak intensity 1.9 cd/lm  
 LEDs/each optic 1  
 Light colour White  
 Required components:  
 F15255\_HEKLA-SOCKET-C

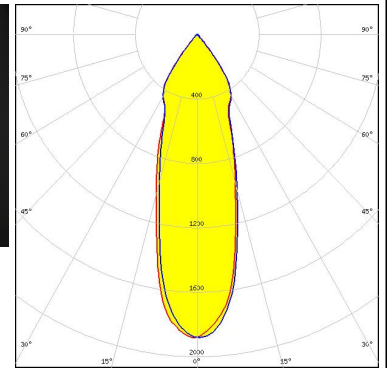
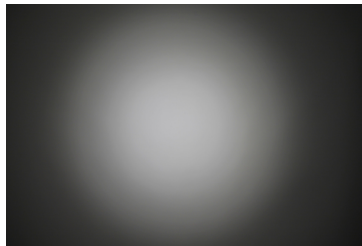

#### CITIZEN

LED CLU700/701/702  
 FWHM / FWTM 29.0° / 77.0°  
 Efficiency 92 %  
 Peak intensity 2 cd/lm  
 LEDs/each optic 1  
 Light colour White  
 Required components:  
 F15255\_HEKLA-SOCKET-C

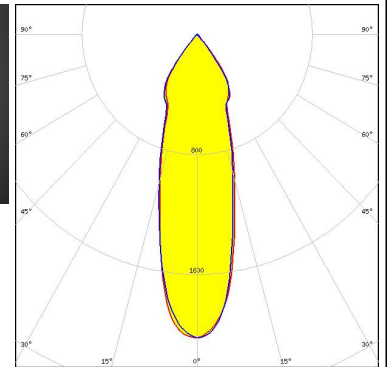
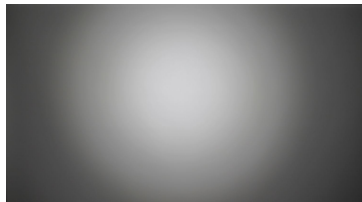

#### CITIZEN

LED CLU700/701/702  
 FWHM / FWTM 29.0° / 77.0°  
 Efficiency 91 %  
 Peak intensity 2 cd/lm  
 LEDs/each optic 1  
 Light colour White  
 Required components:  
 F15255\_HEKLA-SOCKET-C  
 C13723\_MIRELLA-RZL

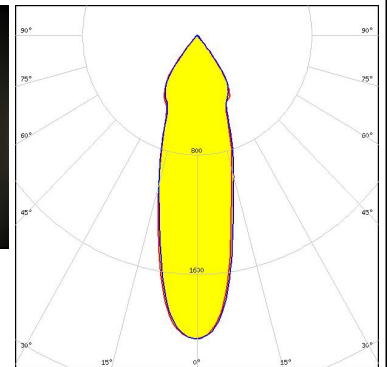
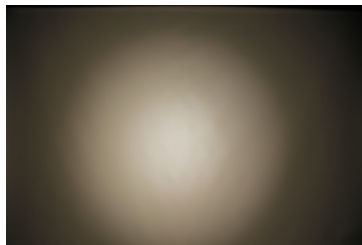

#### PHOTOMETRIC DATA (MEASURED):

#### CITIZEN

LED CLU710/711  
 FWHM / FWTM 37.0° / 79.0°  
 Efficiency 87 %  
 Peak intensity 1.5 cd/lm  
 LEDs/each optic 1  
 Light colour White  
 Required components:  
 F15859\_HEKLA-SOCKET-I

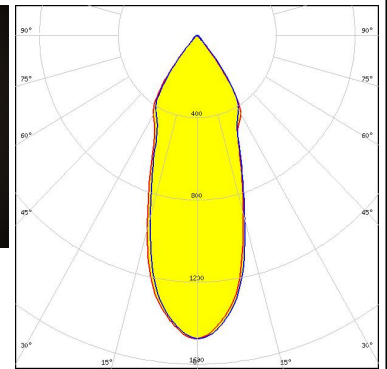
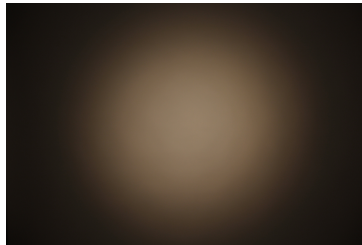

#### CITIZEN

LED CLU7A2 (LES 4.2mm)  
 FWHM / FWTM 24.0° / 77.0°  
 Efficiency 89 %  
 Peak intensity 2.1 cd/lm  
 LEDs/each optic 1  
 Light colour White  
 Required components:  
 F15255\_HEKLA-SOCKET-C

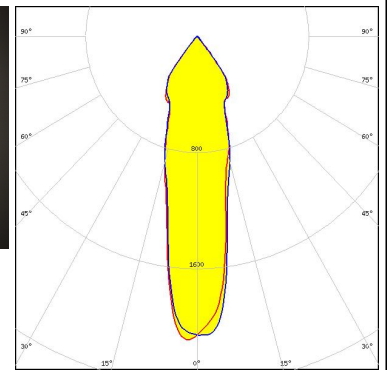
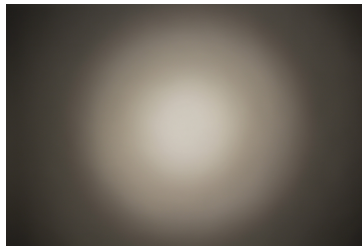

#### CITIZEN

LED LCN-C01B (Tunable White)  
 FWHM / FWTM 42.0° / 81.0°  
 Efficiency 77 %  
 Peak intensity 1.1 cd/lm  
 LEDs/each optic 1  
 Light colour White  
 Required components:  
 C16142\_HEKLA-SOCKET-K  
 C13723\_MIRELLA-RZL  
 Bender Wirth: 481 Typ L8

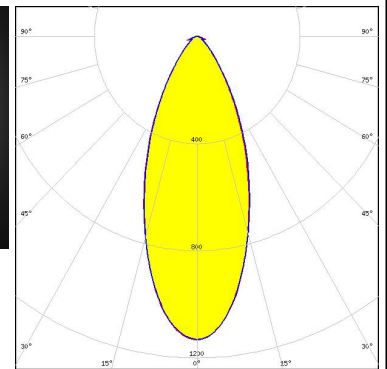
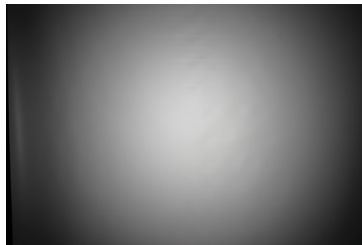

#### CITIZEN

LED LCN-C01B (Tunable White)  
 FWHM / FWTM 42.0° / 81.0°  
 Efficiency 77 %  
 Peak intensity 1.1 cd/lm  
 LEDs/each optic 1  
 Light colour White  
 Required components:  
 C16142\_HEKLA-SOCKET-K  
 C13723\_MIRELLA-RZL  
 Bender Wirth: 481 Typ L8

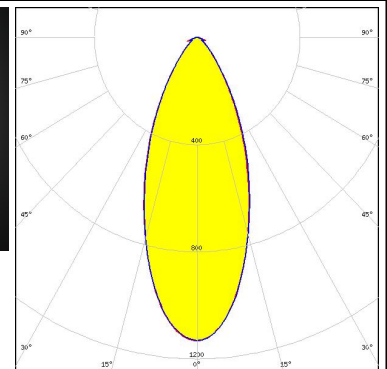
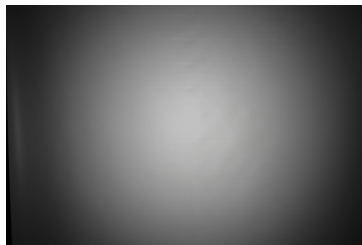



#### PHOTOMETRIC DATA (MEASURED):



LED CMA1516  
 FWHM / FWTM 40.0° / 82.0°  
 Efficiency 88 %  
 Peak intensity 1.3 cd/lm  
 LEDs/each optic 1  
 Light colour White  
 Required components:  
 F15256\_HEKLA-SOCKET-D

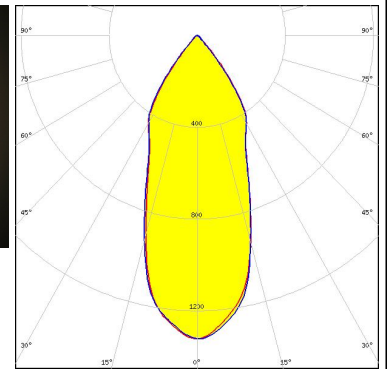

LED CMT14xx  
 FWHM / FWTM 41.0° / 82.0°  
 Efficiency 88 %  
 Peak intensity 1.3 cd/lm  
 LEDs/each optic 1  
 Light colour White  
 Required components:  
 F15255\_HEKLA-SOCKET-C

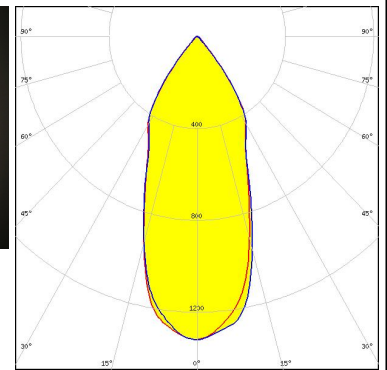

LED CXA/B 13xx  
 FWHM / FWTM 30.0° / 77.0°  
 Efficiency 92 %  
 Peak intensity 1.9 cd/lm  
 LEDs/each optic 1  
 Light colour White  
 Required components:  
 F15956\_HEKLA-SOCKET-J  
 C13333\_MIRELLA-CL

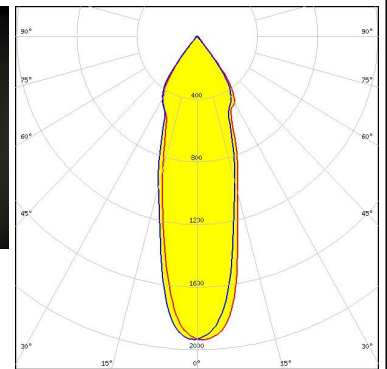

LED CXA/B 13xx  
 FWHM / FWTM 32.0° / 78.0°  
 Efficiency 91 %  
 Peak intensity 1.8 cd/lm  
 LEDs/each optic 1  
 Light colour White  
 Required components:  
 F15956\_HEKLA-SOCKET-J

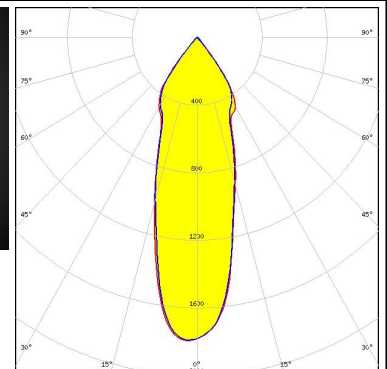
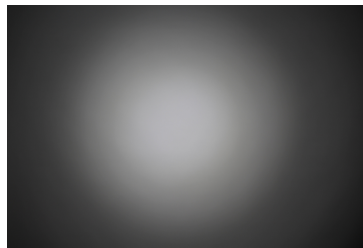

#### PHOTOMETRIC DATA (MEASURED):



LED CXA/B 15xx  
 FWHM / FWTM 37.0° / 79.0°  
 Efficiency 91 %  
 Peak intensity 1.6 cd/m  
 LEDs/each optic 1  
 Light colour White  
 Required components:  
 F15256\_HEKLA-SOCKET-D

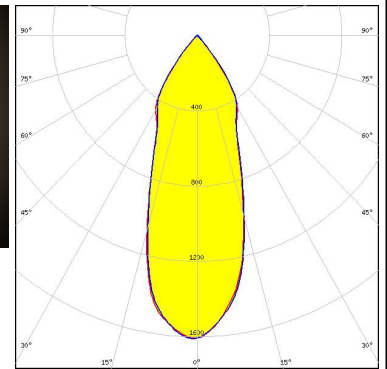
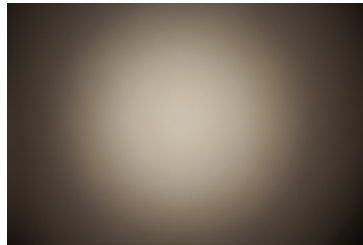

LED LUXEON CoB 1202/1203  
 FWHM / FWTM 38.0° / 79.0°  
 Efficiency 90 %  
 Peak intensity 1.5 cd/m  
 LEDs/each optic 1  
 Light colour White  
 Required components:  
 F15858\_HEKLA-SOCKET-H

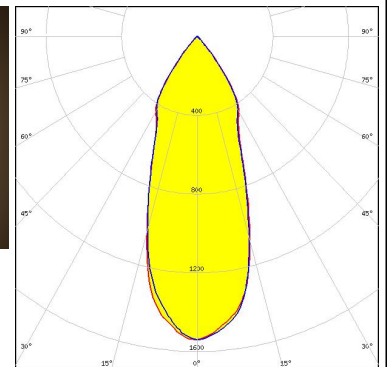
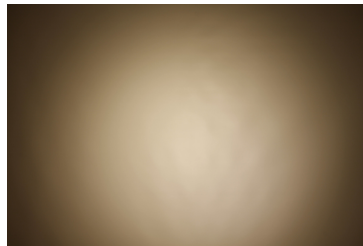

LED LUXEON CoB 1202/1203  
 FWHM / FWTM 38.0° / 79.0°  
 Efficiency 90 %  
 Peak intensity 1.5 cd/m  
 LEDs/each optic 1  
 Light colour White  
 Required components:  
 F15858\_HEKLA-SOCKET-H

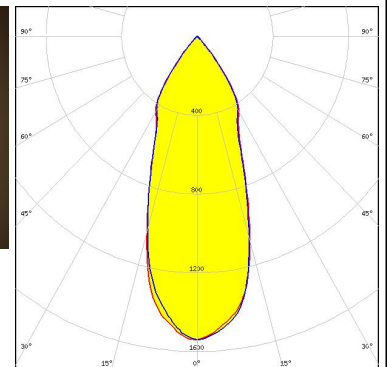
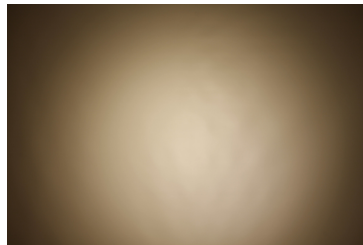



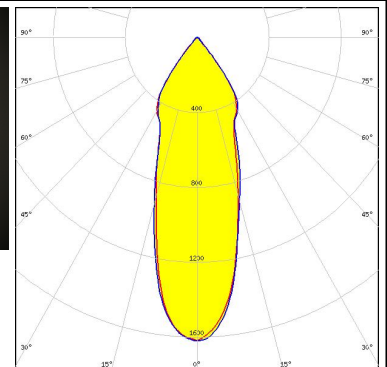
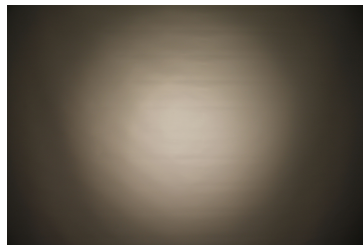

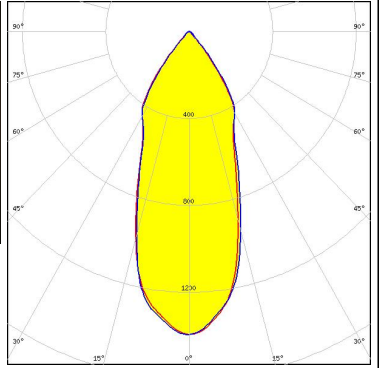
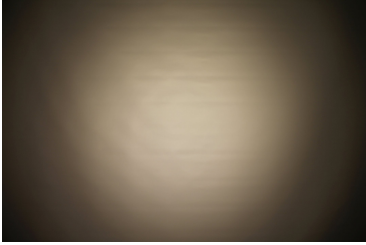
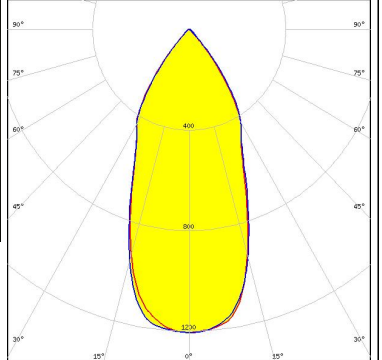
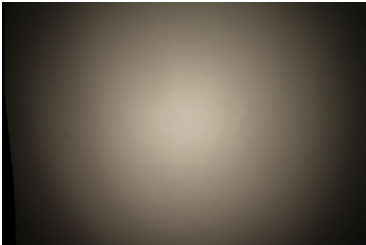
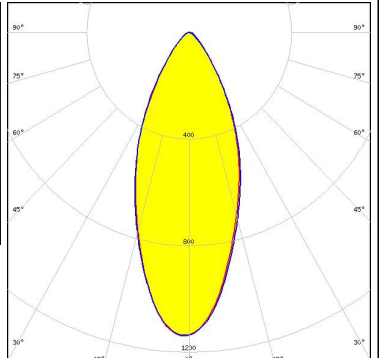
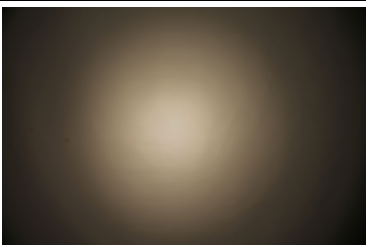
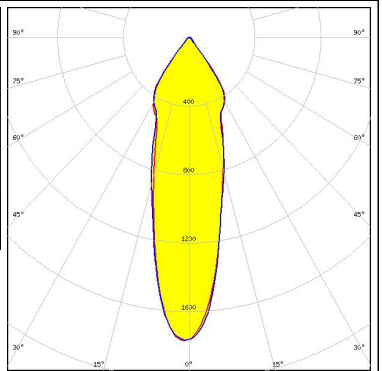

LED LUXEON CoB 1202HD  
 FWHM / FWTM 33.0° / 79.0°  
 Efficiency 88 %  
 Peak intensity 1.6 cd/m  
 LEDs/each optic 1  
 Light colour White  
 Required components:  
 F15848\_HEKLA-SOCKET-G

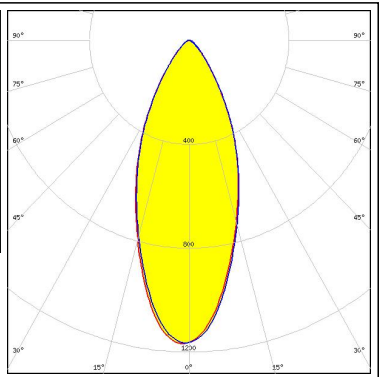

#### PHOTOMETRIC DATA (MEASURED):

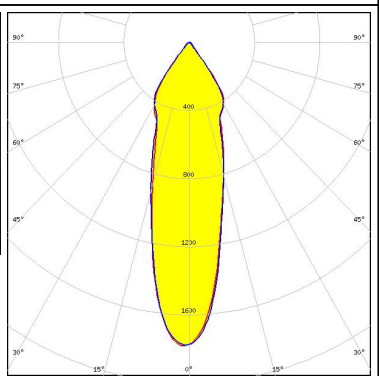
<p><b>LUMILEDS</b></p> <p>LED LUXEON CoB 1204HD</p> <p>FWHM / FWTM 40.0° / 81.0°</p> <p>Efficiency 89 %</p> <p>Peak intensity 1.4 cd/m</p> <p>LEDs/each optic 1</p> <p>Light colour White</p> <p>Required components: F15858_HEKLA-SOCKET-H</p>		
<p><b>LUMILEDS</b></p> <p>LED LUXEON CoB 1205HD</p> <p>FWHM / FWTM 44.0° / 83.0°</p> <p>Efficiency 87 %</p> <p>Peak intensity 1.2 cd/m</p> <p>LEDs/each optic 1</p> <p>Light colour White</p> <p>Required components: F15858_HEKLA-SOCKET-H</p>		
<p><b>LUMILEDS</b></p> <p>LED LUXEON CX Plus CoB - HD S01H4</p> <p>FWHM / FWTM 42.0° / 82.0°</p> <p>Efficiency 76 %</p> <p>Peak intensity 1.1 cd/m</p> <p>LEDs/each optic 1</p> <p>Light colour White</p> <p>Required components: C13723_MIRELLA-RZL Bender Wirth: 634c Hekla</p>		
<p><b>LUMILEDS</b></p> <p>LED LUXEON CX Plus CoB - HD S01H4</p> <p>FWHM / FWTM 28.0° / 77.0°</p> <p>Efficiency 84 %</p> <p>Peak intensity 1.8 cd/m</p> <p>LEDs/each optic 1</p> <p>Light colour White</p> <p>Required components: Bender Wirth: 634c Hekla</p>		

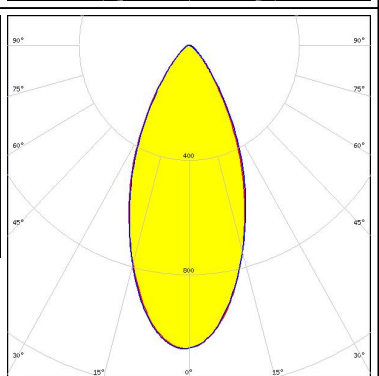

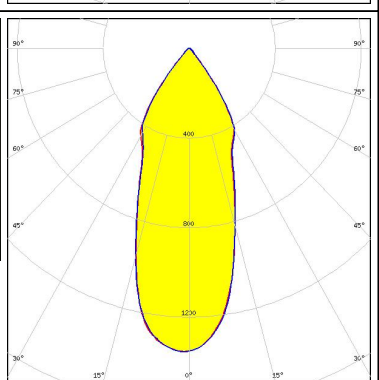

#### PHOTOMETRIC DATA (MEASURED):

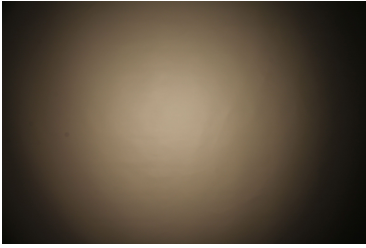
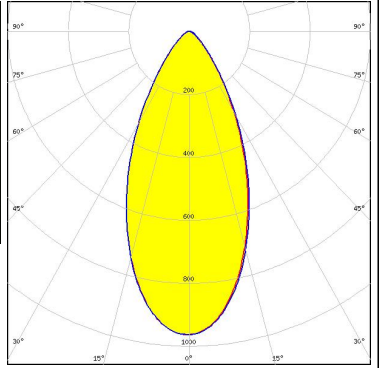
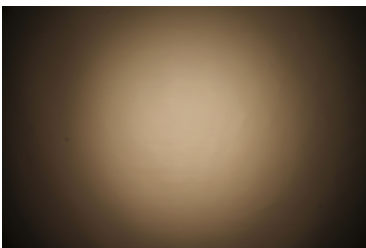
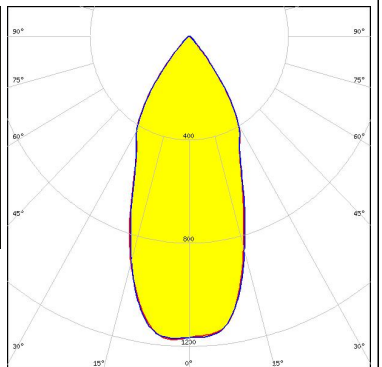
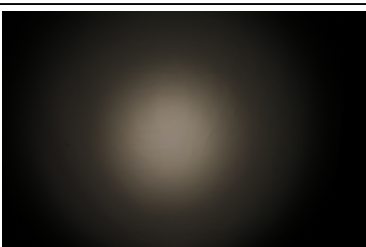
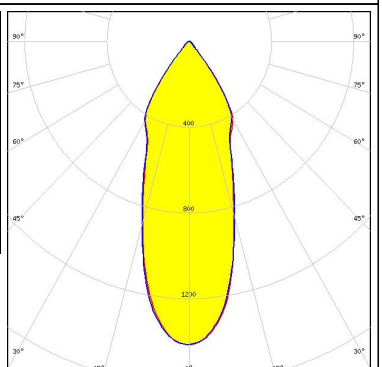
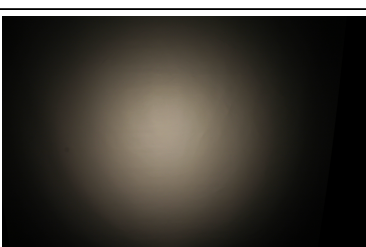
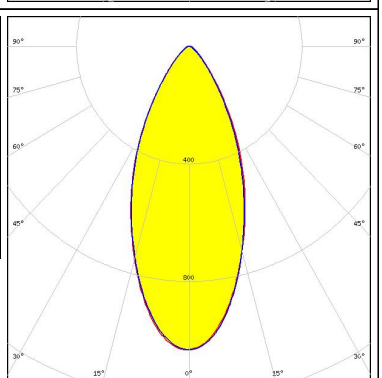
<p><b>LUMILEDS</b></p> <p>LED LUXEON CX Plus CoB - HD S01H6 / HD S02H6</p> <p>FWHM / FWTM 42.0° / 81.0°</p> <p>Efficiency 77 %</p> <p>Peak intensity 1.2 cd/lm</p> <p>LEDs/each optic 1</p> <p>Light colour White</p> <p>Required components: C13723_MIRELLA-RZL Bender Wirth: 634c Hekla</p>		
<p><b>LUMILEDS</b></p> <p>LED LUXEON CX Plus CoB - HD S01H6 / HD S02H6</p> <p>FWHM / FWTM 29.0° / 77.0°</p> <p>Efficiency 84 %</p> <p>Peak intensity 1.8 cd/lm</p> <p>LEDs/each optic 1</p> <p>Light colour White</p> <p>Required components: Bender Wirth: 634c Hekla</p>		
<p><b>LUMILEDS</b></p> <p>LED LUXEON CX Plus CoB - HD S04H9</p> <p>FWHM / FWTM 46.0° / 84.0°</p> <p>Efficiency 78 %</p> <p>Peak intensity 1.1 cd/lm</p> <p>LEDs/each optic 1</p> <p>Light colour White</p> <p>Required components: C13723_MIRELLA-RZL Bender Wirth: 634c Hekla</p>		
<p><b>LUMILEDS</b></p> <p>LED LUXEON CX Plus CoB - HD S04H9</p> <p>FWHM / FWTM 38.0° / 80.0°</p> <p>Efficiency 85 %</p> <p>Peak intensity 1.4 cd/lm</p> <p>LEDs/each optic 1</p> <p>Light colour White</p> <p>Required components: Bender Wirth: 634c Hekla</p>		



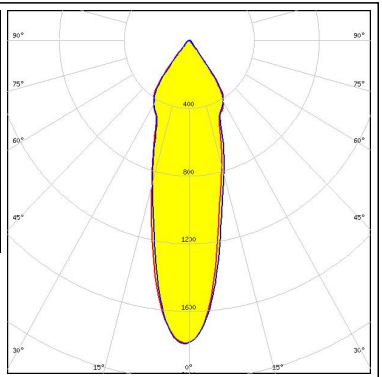

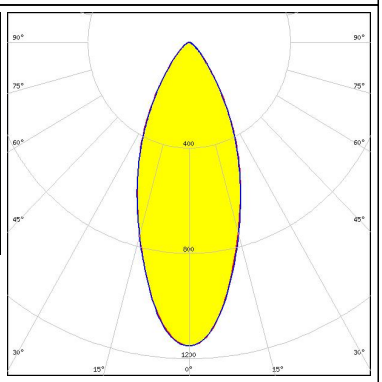
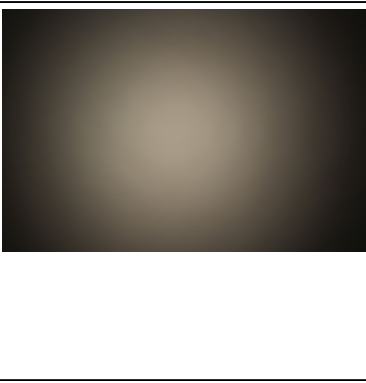
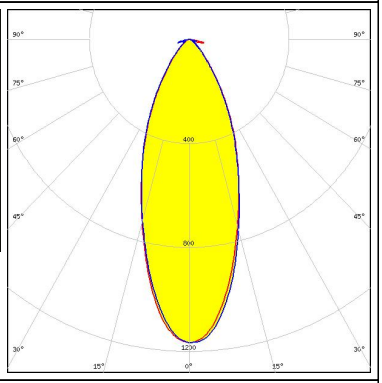
#### PHOTOMETRIC DATA (MEASURED):

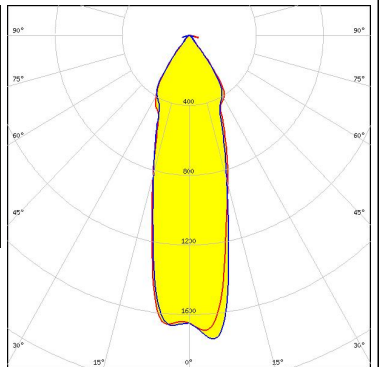
<p><b>LUMILEDS</b></p> <p>LED LUXEON CX Plus CoB L04 / L05 (Gen2)</p> <p>FWHM / FWTM 48.0° / 87.0°</p> <p>Efficiency 75 %</p> <p>Peak intensity 1 cd/lm</p> <p>LEDs/each optic 1</p> <p>Light colour White</p> <p>Required components: C13723_MIRELLA-RZL Bender Wirth: 637a Hekla</p>		
<p><b>LUMILEDS</b></p> <p>LED LUXEON CX Plus CoB L04 / L05 (Gen2)</p> <p>FWHM / FWTM 44.0° / 82.0°</p> <p>Efficiency 83 %</p> <p>Peak intensity 1.2 cd/lm</p> <p>LEDs/each optic 1</p> <p>Light colour White</p> <p>Required components: Bender Wirth: 637a Hekla</p>		
<p><b>LUMILEDS</b></p> <p>LED LUXEON CX Plus CoB M02 / M03 (Gen2)</p> <p>FWHM / FWTM 36.0° / 79.0°</p> <p>Efficiency 84 %</p> <p>Peak intensity 1.4 cd/lm</p> <p>LEDs/each optic 1</p> <p>Light colour White</p> <p>Required components: Bender Wirth: 641a Hekla</p>		
<p><b>LUMILEDS</b></p> <p>LED LUXEON CX Plus CoB M02 / M03 (Gen2)</p> <p>FWHM / FWTM 45.0° / 84.0°</p> <p>Efficiency 75 %</p> <p>Peak intensity 1 cd/lm</p> <p>LEDs/each optic 1</p> <p>Light colour White</p> <p>Required components: C13723_MIRELLA-RZL Bender Wirth: 641a Hekla</p>		



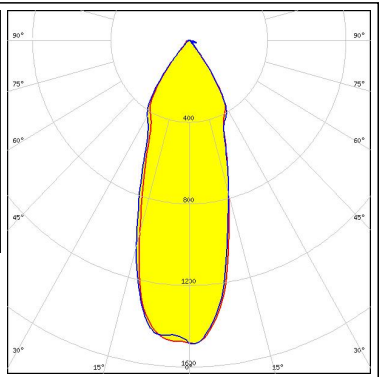

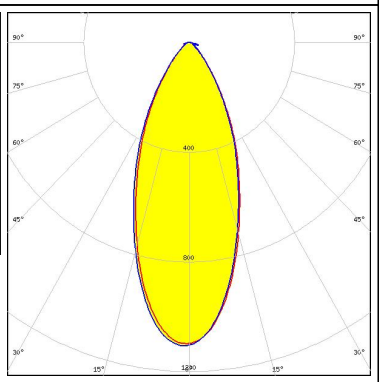
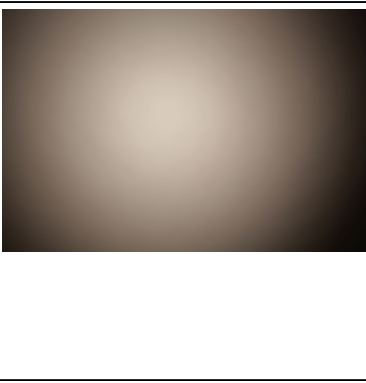
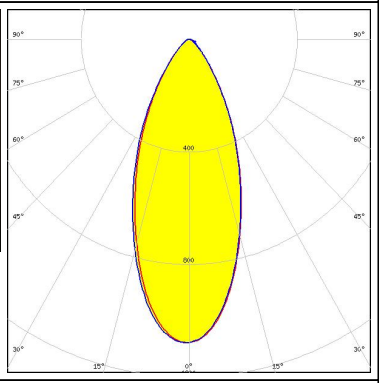

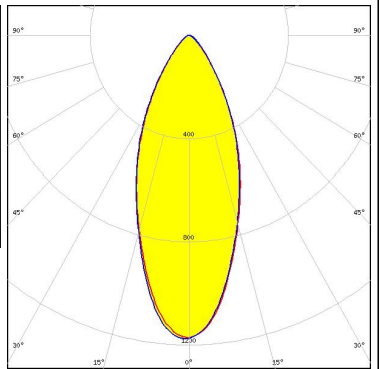
#### PHOTOMETRIC DATA (MEASURED):

<p><b>LUMILEDS</b></p> <p>LED LUXEON CX Plus CoB S01 (Gen2)</p> <p>FWHM / FWTM 28.0° / 77.0°</p> <p>Efficiency 84 %</p> <p>Peak intensity 1.8 cd/lm</p> <p>LEDs/each optic 1</p> <p>Light colour White</p> <p>Required components: Bender Wirth: 634c Hekla</p>		
<p><b>LUMILEDS</b></p> <p>LED LUXEON CX Plus CoB S01 (Gen2)</p> <p>FWHM / FWTM 41.0° / 82.0°</p> <p>Efficiency 76 %</p> <p>Peak intensity 1.2 cd/lm</p> <p>LEDs/each optic 1</p> <p>Light colour White</p> <p>Required components: C13723_MIRELLA-RZL Bender Wirth: 634c Hekla</p>		
<p><b>LUMINUS</b></p> <p>LED CDM-6 (Dim-To-Warm)</p> <p>FWHM / FWTM 39.0° / 81.0°</p> <p>Efficiency 76 %</p> <p>Peak intensity 1.2 cd/lm</p> <p>LEDs/each optic 1</p> <p>Light colour White</p> <p>Required components: C16142_HEKLA-SOCKET-K C13723_MIRELLA-RZL Bender Wirth: 490 Typ L8</p>		
<p><b>LUMINUS</b></p> <p>LED CDM-6 (Dim-To-Warm)</p> <p>FWHM / FWTM 30.0° / 76.0°</p> <p>Efficiency 84 %</p> <p>Peak intensity 1.8 cd/lm</p> <p>LEDs/each optic 1</p> <p>Light colour White</p> <p>Required components: C16142_HEKLA-SOCKET-K Bender Wirth: 490 Typ L8</p>		

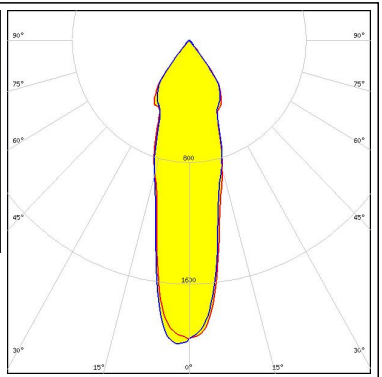
#### PHOTOMETRIC DATA (MEASURED):

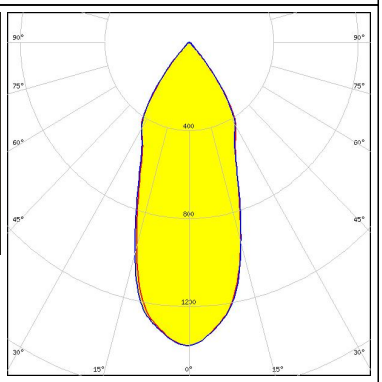

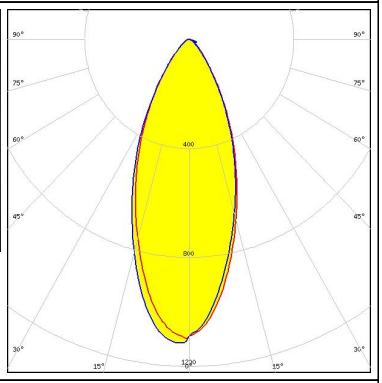

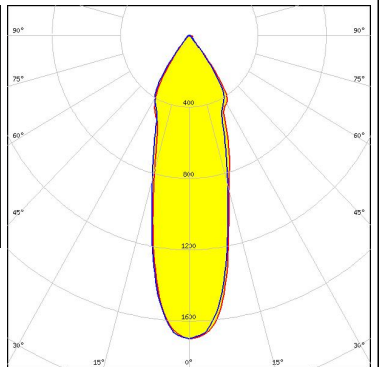
<p><b>LUMINUS</b></p> <p>LED CDM-9 (Dim-To-Warm)</p> <p>FWHM / FWTM 35.0° / 78.0°</p> <p>Efficiency 83 %</p> <p>Peak intensity 1.5 cd/lm</p> <p>LEDs/each optic 1</p> <p>Light colour White</p> <p>Required components: C16142_HEKLA-SOCKET-K Bender Wirth: 490 Typ L8</p>		
<p><b>LUMINUS</b></p> <p>LED CDM-9 (Dim-To-Warm)</p> <p>FWHM / FWTM 42.0° / 82.0°</p> <p>Efficiency 75 %</p> <p>Peak intensity 1.1 cd/lm</p> <p>LEDs/each optic 1</p> <p>Light colour White</p> <p>Required components: C16142_HEKLA-SOCKET-K C13723_MIRELLA-RZL Bender Wirth: 490 Typ L8</p>		
<p><b>LUMINUS</b></p> <p>LED CTM-9 (Tunable White)</p> <p>FWHM / FWTM 43.0° / 82.0°</p> <p>Efficiency 75 %</p> <p>Peak intensity 1.1 cd/lm</p> <p>LEDs/each optic 1</p> <p>Light colour White</p> <p>Required components: C16142_HEKLA-SOCKET-K C13723_MIRELLA-RZL Bender Wirth: 495 Typ L8</p>		
<p><b>LUMINUS</b></p> <p>LED CXM-4</p> <p>FWHM / FWTM 41.0° / 82.0°</p> <p>Efficiency 79 %</p> <p>Peak intensity 1.2 cd/lm</p> <p>LEDs/each optic 1</p> <p>Light colour White</p> <p>Required components: F15255_HEKLA-SOCKET-C C13723_MIRELLA-RZL</p>		

#### PHOTOMETRIC DATA (MEASURED):

<p><b>LUMINUS</b></p> <p>LED CXM-4            FWHM / FWTM 26.0° / 77.0°            Efficiency 88 %            Peak intensity 2 cd/lm            LEDs/each optic 1            Light colour White            Required components:            F15255_HEKLA-SOCKET-C</p>		
<p><b>LUMINUS</b></p> <p>LED CxM-9 (13.5x13.5)            FWHM / FWTM 40.0° / 81.0°            Efficiency 89 %            Peak intensity 1.4 cd/lm            LEDs/each optic 1            Light colour White            Required components:            F15255_HEKLA-SOCKET-C</p>		
<p><b>NICHIA</b></p> <p>LED NJCWL024Z-V1MT: COB L-Type Tunable White            FWHM / FWTM 41.0° / 81.0°            Efficiency 74 %            Peak intensity 1.1 cd/lm            LEDs/each optic 1            Light colour White            Required components:            C16142_HEKLA-SOCKET-K            C13723_MIRELLA-RZL            Bender Wirth: 497 Typ L8</p>		
<p><b>NICHIA</b></p> <p>LED NJCWL024Z-V1MT: COB L-Type Tunable White            FWHM / FWTM 30.0° / 76.0°            Efficiency 83 %            Peak intensity 1.7 cd/lm            LEDs/each optic 1            Light colour White            Required components:            C16142_HEKLA-SOCKET-K            Bender Wirth: 497 Typ L8</p>		

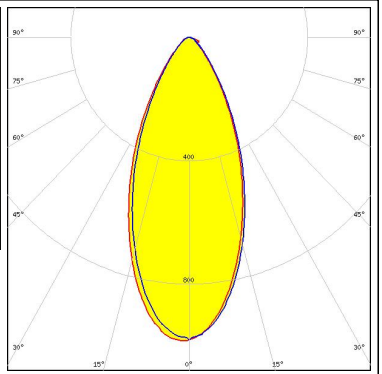
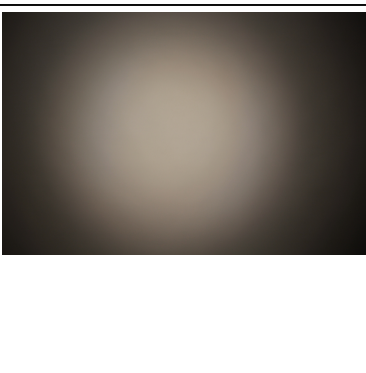
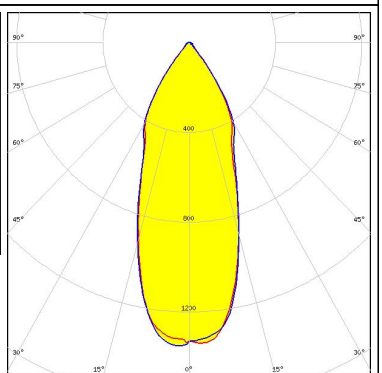

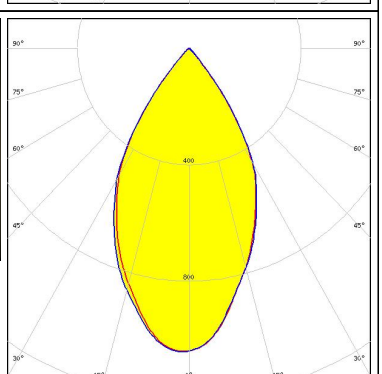
#### PHOTOMETRIC DATA (MEASURED):

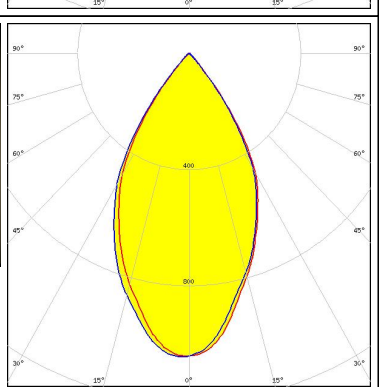
<p><b>NICHIA</b></p> <p>LED NVCWJ024Z-V1MT: COB J-Type Tunable White</p> <p>FWHM / FWTM 45.0° / 85.0°</p> <p>Efficiency 74 %</p> <p>Peak intensity 1 cd/lm</p> <p>LEDs/each optic 1</p> <p>Light colour White</p> <p>Required components:</p> <ul style="list-style-type: none"> <li>C16142_HEKLA-SOCKET-K</li> <li>C13723_MIRELLA-RZL</li> <li>Bender Wirth: 498 Typ L8</li> </ul>		
<p><b>NICHIA</b></p> <p>LED NVCWJ024Z-V1MT: COB J-Type Tunable White</p> <p>FWHM / FWTM 39.0° / 79.0°</p> <p>Efficiency 84 %</p> <p>Peak intensity 1.3 cd/lm</p> <p>LEDs/each optic 1</p> <p>Light colour White</p> <p>Required components:</p> <ul style="list-style-type: none"> <li>C16142_HEKLA-SOCKET-K</li> <li>Bender Wirth: 498 Typ L8</li> </ul>		
<p><b>OSRAM</b> Opto Semiconductors</p> <p>LED Soleriq S9</p> <p>FWHM / FWTM 57.0° / 82.0°</p> <p>Efficiency 84 %</p> <p>Peak intensity 1 cd/lm</p> <p>LEDs/each optic 1</p> <p>Light colour White</p> <p>Required components:</p> <ul style="list-style-type: none"> <li>F15255_HEKLA-SOCKET-C</li> </ul>		
<p><b>OSRAM</b> Opto Semiconductors</p> <p>LED Soleriq S9</p> <p>FWHM / FWTM 57.0° / 82.0°</p> <p>Efficiency 84 %</p> <p>Peak intensity 1 cd/lm</p> <p>LEDs/each optic 1</p> <p>Light colour White</p> <p>Required components:</p> <ul style="list-style-type: none"> <li>F15255_HEKLA-SOCKET-C</li> <li>C12479_MIRELLA-DL</li> </ul>		

#### PHOTOMETRIC DATA (MEASURED):

#### PHILIPS

LED Fortimo SLM L09 CoB  
 FWHM / FWTM 46.0° / 85.0°  
 Efficiency 79 %  
 Peak intensity 1.1 cd/lm  
 LEDs/each optic 1  
 Light colour White  
 Required components:  
 F15858\_HEKLA-SOCKET-H  
 C13723\_MIRELLA-RZL

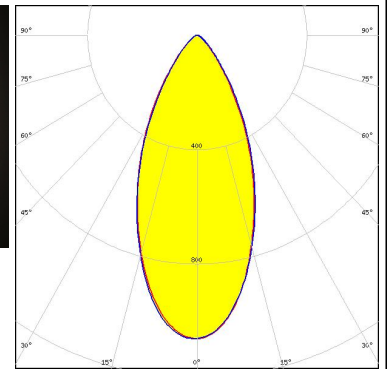
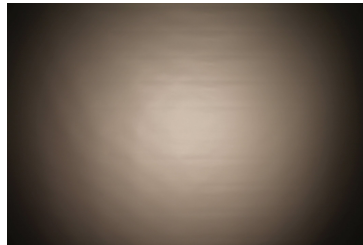

#### PHILIPS

LED Fortimo SLM L09 CoB  
 FWHM / FWTM 39.0° / 81.0°  
 Efficiency 88 %  
 Peak intensity 1.4 cd/lm  
 LEDs/each optic 1  
 Light colour White  
 Required components:  
 F15858\_HEKLA-SOCKET-H

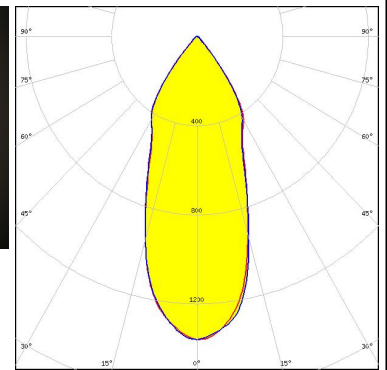
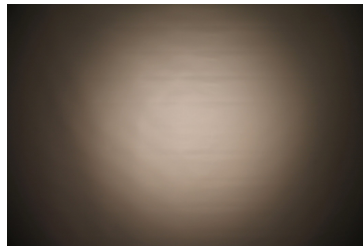

#### PHILIPS

LED Fortimo SLM L13 CoB  
 FWHM / FWTM 49.0° / 86.0°  
 Efficiency 77 %  
 Peak intensity 0.9 cd/lm  
 LEDs/each optic 1  
 Light colour White  
 Required components:  
 C16142\_HEKLA-SOCKET-K  
 C13723\_MIRELLA-RZL  
 Bender Wirth: 432 Typ L8

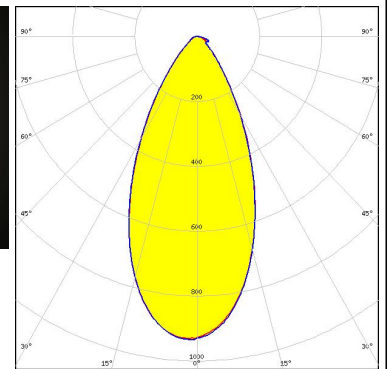
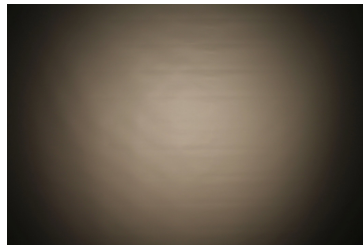

#### PHILIPS

LED Fortimo SLM L13 CoB  
 FWHM / FWTM 47.0° / 82.0°  
 Efficiency 83 %  
 Peak intensity 1.1 cd/lm  
 LEDs/each optic 1  
 Light colour White  
 Required components:  
 C16142\_HEKLA-SOCKET-K  
 Bender Wirth: 432 Typ L8

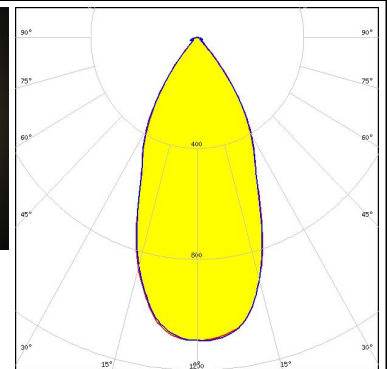
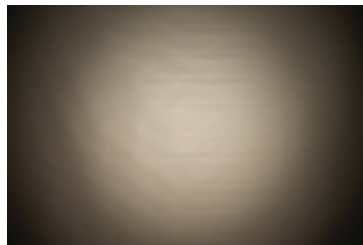

#### PHOTOMETRIC DATA (MEASURED):

### PHILIPS

LED Fortimo SLM L13 CoB  
 FWHM / FWTM 47.0° / 83.0°  
 Efficiency 83 %  
 Peak intensity 1.1 cd/m  
 LEDs/each optic 1  
 Light colour White  
 Required components:  
 C16142\_HEKLA-SOCKET-K  
 Bender Wirth: 432 Typ L8



### PHILIPS

LED Fortimo SLM L13 CoB  
 FWHM / FWTM 49.0° / 87.0°  
 Efficiency 77 %  
 Peak intensity 0.9 cd/m  
 LEDs/each optic 1  
 Light colour White  
 Required components:  
 C16142\_HEKLA-SOCKET-K  
 C13723\_MIRELLA-RZL  
 Bender Wirth: 432 Typ L8

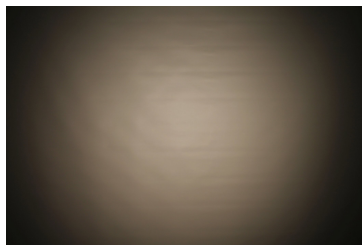

### SAMSUNG

LED LC010C G2  
 FWHM / FWTM 29.0° / 78.0°  
 Efficiency 88 %  
 Peak intensity 1.8 cd/m  
 LEDs/each optic 1  
 Light colour White  
 Required components:  
 F15255\_HEKLA-SOCKET-C

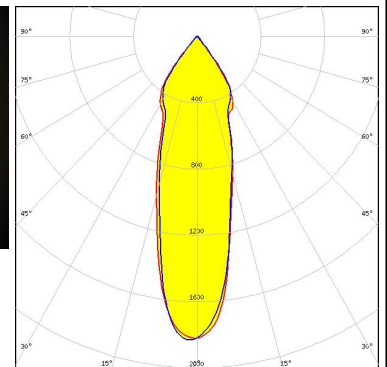
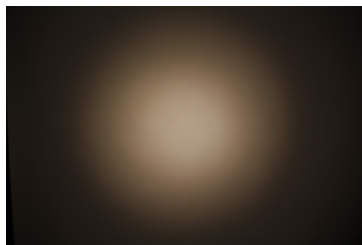

### SAMSUNG

LED LC010T (Tunable White)  
 FWHM / FWTM 37.0° / 75.0°  
 Efficiency 79 %  
 Peak intensity 1.3 cd/m  
 LEDs/each optic 1  
 Light colour Tunable White  
 Required components:  
 C16142\_HEKLA-SOCKET-K  
 C14658\_BARBARA-RZ-LENS  
 Bender Wirth: 501 Typ L8

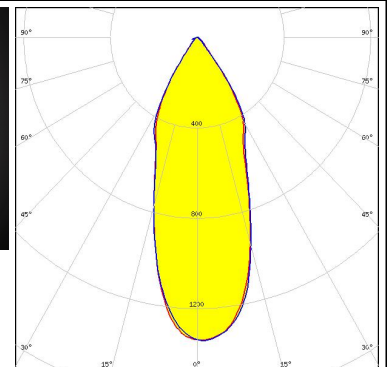
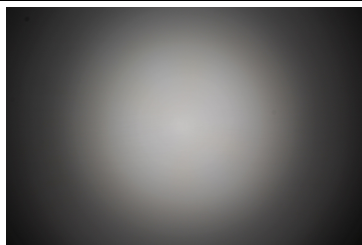

#### PHOTOMETRIC DATA (MEASURED):

### SAMSUNG

LED LC010T (Tunable White)  
 FWHM / FWTM 36.0° / 77.0°  
 Efficiency 84 %  
 Peak intensity 1.4 cd/lm  
 LEDs/each optic 1  
 Light colour Tunable White  
 Required components:  
 C16142\_HEKLA-SOCKET-K  
 Bender Wirth: 501 Typ L8

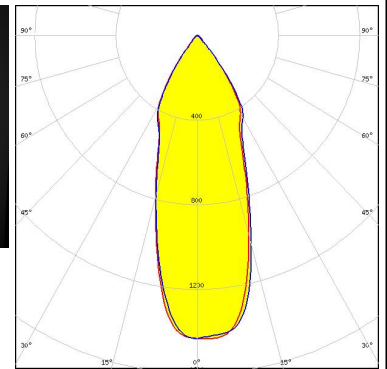

### SAMSUNG

LED LC016D / LC019D / LC026D / LC033D  
 FWHM / FWTM 52.0° / 85.0°  
 Efficiency 87 %  
 Peak intensity 1.1 cd/lm  
 LEDs/each optic 1  
 Light colour White  
 Required components:  
 F15859\_HEKLA-SOCKET-I

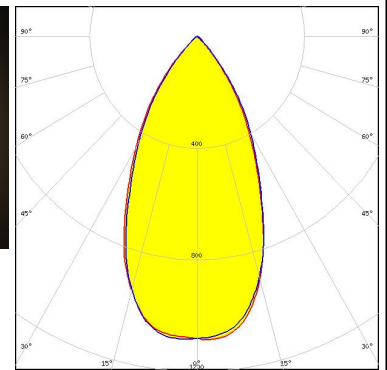
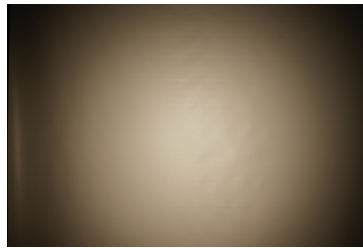

### SAMSUNG

LED LC016D / LC019D / LC026D / LC033D  
 FWHM / FWTM 51.0° / 90.0°  
 Efficiency 77 %  
 Peak intensity 0.9 cd/lm  
 LEDs/each optic 1  
 Light colour White  
 Required components:  
 F15859\_HEKLA-SOCKET-I  
 C13723\_MIRELLA-RZL

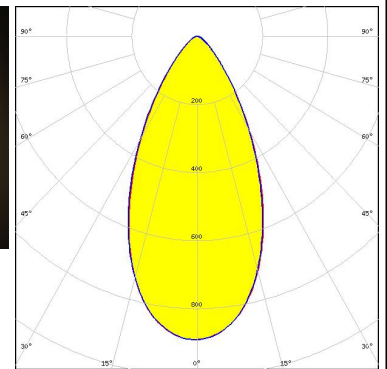
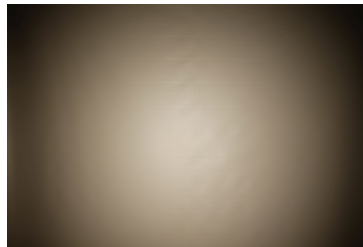

### SAMSUNG

LED LC016D / LC019D / LC026D / LC033D  
 FWHM / FWTM 53.0° / 83.0°  
 Efficiency 82 %  
 Peak intensity 1 cd/lm  
 LEDs/each optic 1  
 Light colour White  
 Required components:  
 F15859\_HEKLA-SOCKET-I  
 C13333\_MIRELLA-CL

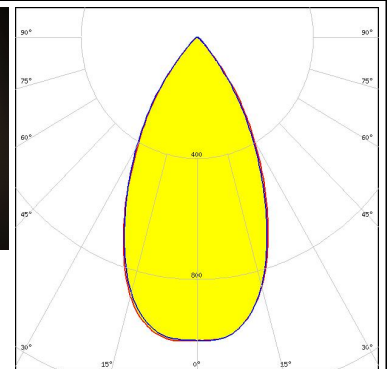
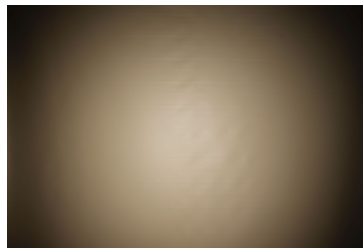

#### PHOTOMETRIC DATA (MEASURED):

### SAMSUNG

LED LC016D / LC019D / LC026D / LC033D  
 FWHM / FWTM 53.0° / 87.0°  
 Efficiency 79 %  
 Peak intensity 0.9 cd/m  
 LEDs/each optic 1  
 Light colour White  
 Required components:  
 F15859\_HEKLA-SOCKET-I  
 C12479\_MIRELLA-DL

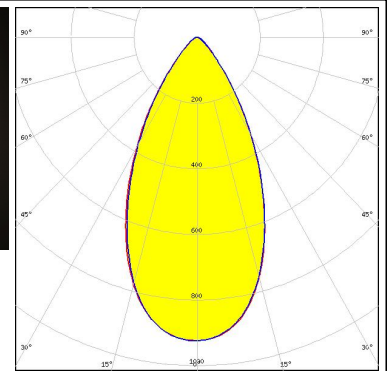
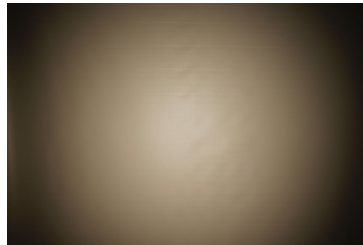

### SAMSUNG

LED LC020C  
 FWHM / FWTM 36.0° / 79.0°  
 Efficiency 90 %  
 Peak intensity 1.6 cd/m  
 LEDs/each optic 1  
 Light colour White  
 Required components:  
 F15848\_HEKLA-SOCKET-G

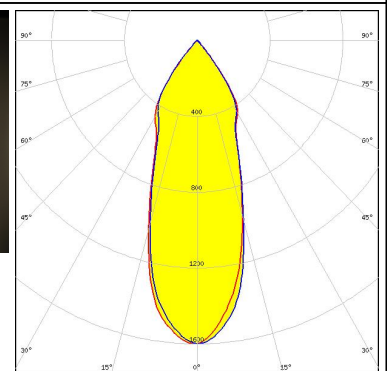
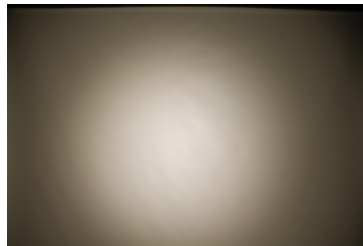

### SAMSUNG

LED LC020C G2  
 FWHM / FWTM 38.0° / 80.0°  
 Efficiency 87 %  
 Peak intensity 1.4 cd/m  
 LEDs/each optic 1  
 Light colour White  
 Required components:  
 F15859\_HEKLA-SOCKET-I

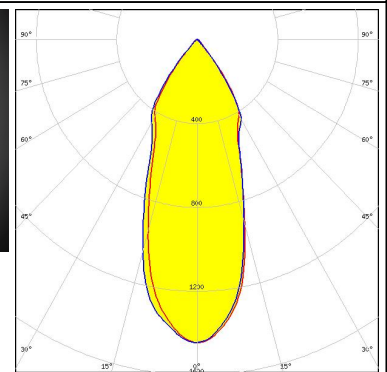
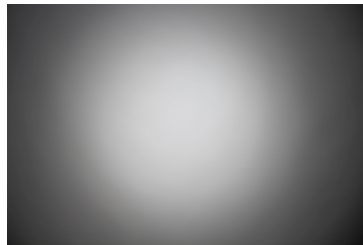

### TRIDONIC

LED SLE G7 LES09  
 FWHM / FWTM 46.0° / 85.0°  
 Efficiency 82 %  
 Peak intensity 1.1 cd/m  
 LEDs/each optic 1  
 Light colour White  
 Required components:  
 F15255\_HEKLA-SOCKET-C  
 C13723\_MIRELLA-RZL

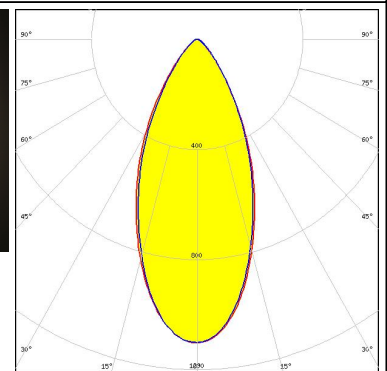
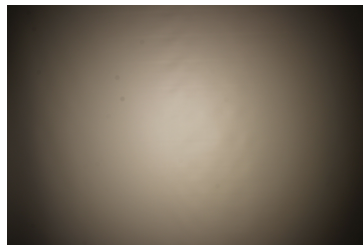

#### PHOTOMETRIC DATA (MEASURED):

#### TRIDONIC

LED SLE G7 LES09  
 FWHM / FWTM 38.0° / 80.0°  
 Efficiency 90 %  
 Peak intensity 1.5 cd/lm  
 LEDs/each optic 1  
 Light colour White  
 Required components:  
 F15255\_HEKLA-SOCKET-C

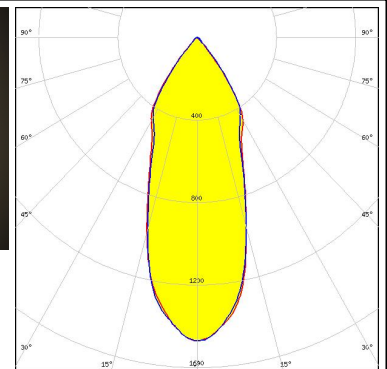
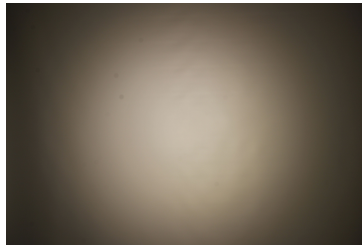

#### TRIDONIC

LED SLE G7 LES13  
 FWHM / FWTM 50.0° / 88.0°  
 Efficiency 77 %  
 Peak intensity 0.9 cd/lm  
 LEDs/each optic 1  
 Light colour White  
 Required components:  
 F15859\_HEKLA-SOCKET-I  
 C13723\_MIRELLA-RZL

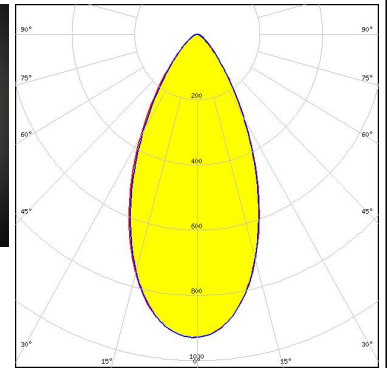
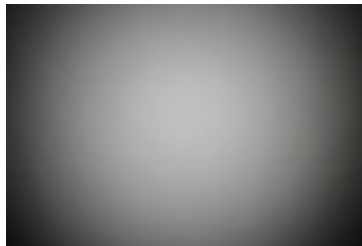

#### TRIDONIC

LED SLE G7 LES13  
 FWHM / FWTM 48.0° / 84.0°  
 Efficiency 86 %  
 Peak intensity 1.1 cd/lm  
 LEDs/each optic 1  
 Light colour White  
 Required components:  
 F15859\_HEKLA-SOCKET-I

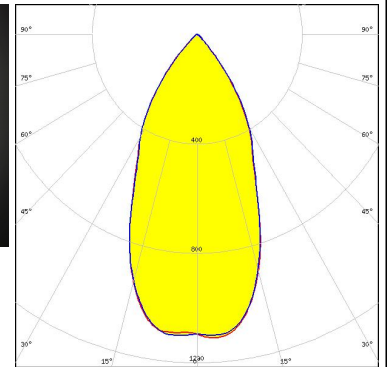
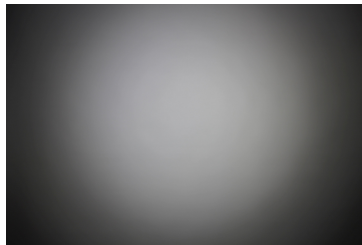

#### XICATO

LED XOB 14.5 mm  
 FWHM / FWTM 51.0° / 89.0°  
 Efficiency 78 %  
 Peak intensity 0.9 cd/lm  
 LEDs/each optic 1  
 Light colour White  
 Required components:  
 F15859\_HEKLA-SOCKET-I  
 C13723\_MIRELLA-RZL

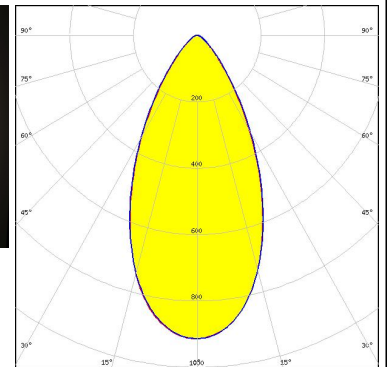
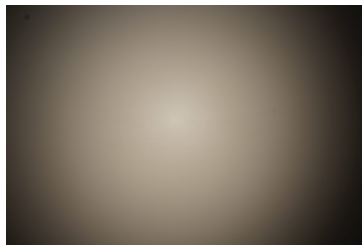

#### PHOTOMETRIC DATA (MEASURED):

#### XICATO

LED XOB 14.5 mm  
 FWHM / FWTM 52.0° / 86.0°  
 Efficiency 86 %  
 Peak intensity 1.1 cd/lm  
 LEDs/each optic 1  
 Light colour White  
 Required components:  
 F15859\_HEKLA-SOCKET-I

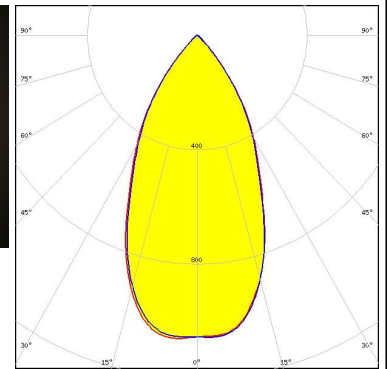

#### XICATO

LED XOB 6 mm  
 FWHM / FWTM 32.0° / 78.0°  
 Efficiency 88 %  
 Peak intensity 1.7 cd/lm  
 LEDs/each optic 1  
 Light colour White  
 Required components:  
 F15255\_HEKLA-SOCKET-C

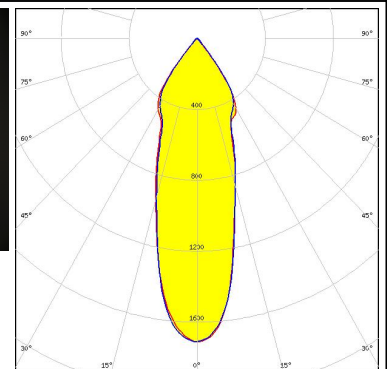
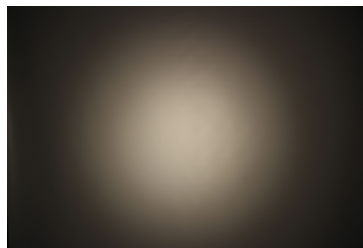

#### XICATO

LED XOB 6 mm  
 FWHM / FWTM 44.0° / 84.0°  
 Efficiency 78 %  
 Peak intensity 1.1 cd/lm  
 LEDs/each optic 1  
 Light colour White  
 Required components:  
 F15255\_HEKLA-SOCKET-C  
 C13723\_MIRELLA-RZL

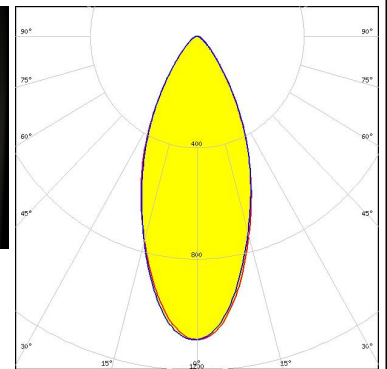
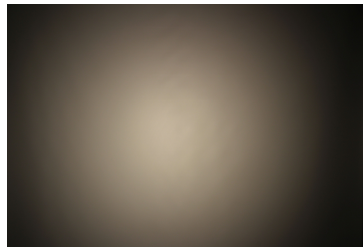

#### XICATO

LED XOB 9.8 mm  
 FWHM / FWTM 47.0° / 85.0°  
 Efficiency 80 %  
 Peak intensity 1.1 cd/lm  
 LEDs/each optic 1  
 Light colour White  
 Required components:  
 F15255\_HEKLA-SOCKET-C  
 C13723\_MIRELLA-RZL

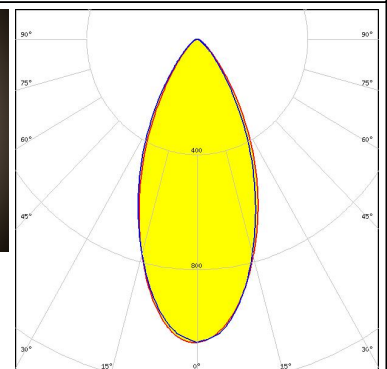
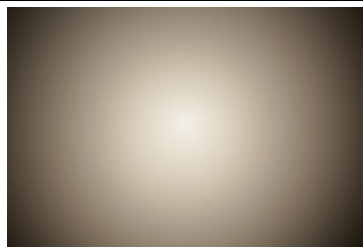

## PHOTOMETRIC DATA (MEASURED):



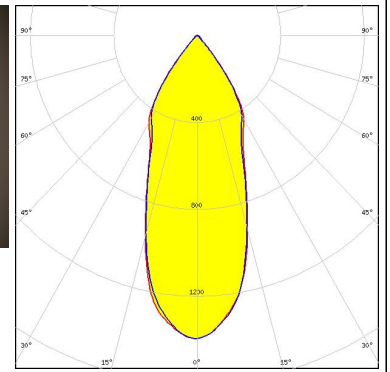

### XICATO

LED XOB 9.8 mm  
FWHM / FWTM 39.0° / 81.0°  
Efficiency 88 %  
Peak intensity 1.4 cd/lm  
LEDs/each optic 1  
Light colour White  
Required components:  
F15255\_HEKLA-SOCKET-C  
C13723\_MIRELLA-RZL



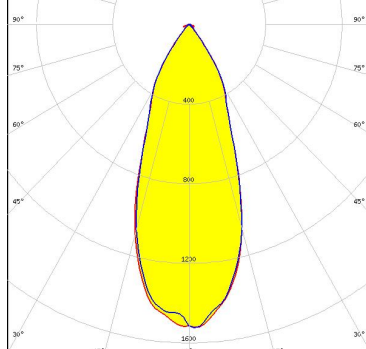
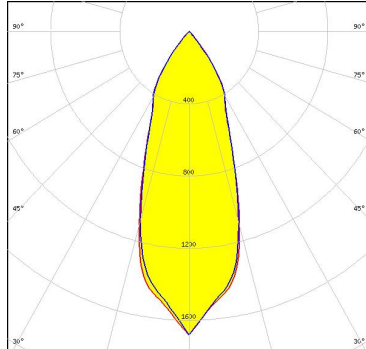

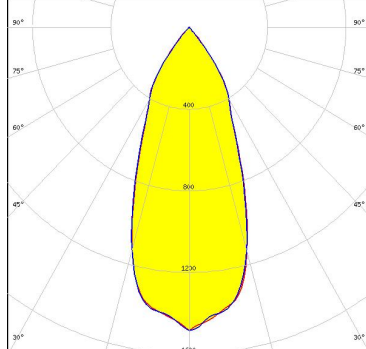
#### PHOTOMETRIC DATA (SIMULATED):

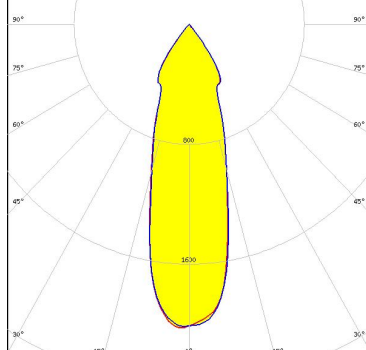
<p> LED VERO13</p> <p>FWHM / FWTM 39.0° / 75.0°</p> <p>Efficiency 87 %</p> <p>Peak intensity 1.5 cd/lm</p> <p>LEDs/each optic 1</p> <p>Light colour White</p> <p>Required components: C16142_HEKLA-SOCKET-K</p>	
<p><b>CITIZEN</b></p> <p>LED CLL02x/CLU02x (LES10)</p> <p>FWHM / FWTM 37.2° / 76.7°</p> <p>Efficiency 88 %</p> <p>Peak intensity 1.7 cd/lm</p> <p>LEDs/each optic 1</p> <p>Light colour White</p> <p>Required components: F15255_HEKLA-SOCKET-C</p>	
<p> LED COB L-Type (LES 11)</p> <p>FWHM / FWTM 42.0° / 78.0°</p> <p>Efficiency 90 %</p> <p>Peak intensity 1.5 cd/lm</p> <p>LEDs/each optic 1</p> <p>Light colour White</p> <p>Required components: F15858_HEKLA-SOCKET-H</p>	
<p> LED COB T-Type</p> <p>FWHM / FWTM 30.0° / 75.0°</p> <p>Efficiency 88 %</p> <p>Peak intensity 2 cd/lm</p> <p>LEDs/each optic 1</p> <p>Light colour White</p> <p>Required components: F15848_HEKLA-SOCKET-G</p>	

#### GENERAL INFORMATION:

NOTE: The typical beam angle will be changed by different color, chip size and chip position tolerance. The typical total beam angle is the full angle measured where the luminous intensity is half of the peak value.

Due to use of high power COB's with this product, special attention to proper thermal design is highly recommended. LEDiL has no liability for direct, indirect or consecutive damages arising from the LEDiL products being used outside of the recommended temperature range.

#### MATERIALS:

As part of our continuous research and improvement processes, and to ensure the best possible quality and availability of our products, LEDiL reserves the right to change material grades without notice.

#### PRODUCT DATA USER AGREEMENT AND DISCLAIMER:

The measured data in the provided downloadable LEDiL Product Datasheets and Mechanical 2D-Drawings is rounded and provided as reference for planning. LEDiL Oy's optical specifications have been verified by conducting performance testing of the products in accordance with the company's quality system. The reported data are averaged results of multiple measurements with typical variation. LEDiL Oy reserves the right to without prior notification make changes and improvements to its products.

LEDiL Oy assumes neither warranty, nor guarantee nor any other liability of any kind for the contents and correctness of the provided data. The provided data has been generated with highest diligence but the provided data may in reality not represent the complete possible variation range of all intrinsic parameters. Therefore, in certain cases a deviation from the provided data could occur.

LEDiL Oy reserves the right to undertake technical changes of its products without further notification which could lead to changes in the provided data. LEDiL Oy assumes no liability of any kind for the possible deviation from any provided data or any other damage resulting from the usage of the provided data.

The user agrees to this disclaimer and user agreement with the download or usage of the provided files.

#### LEDiL Oy

Joensuunkatu 13  
FI-24240 SALO  
Finland

#### LEDiL Inc.

228 West Page Street  
Suite D  
Sycamore IL 60178  
USA

#### Ledil Optics Technology (Shenzhen) Co., Ltd.

# 405 , Block B  
Casic Motor Building  
Shenzhen 518057  
P.R.CHINA

#### Local sales and technical support

[www.ledil.com/  
where\\_to\\_buy](http://www.ledil.com/where_to_buy)

#### Shipping locations

Salo, Finland  
Hong Kong, China

#### Distribution Partners

[www.ledil.com/  
where\\_to\\_buy](http://www.ledil.com/where_to_buy)