



# TAOGLAS®



# Datasheet

## LTE Ultima II

**Part No:**  
G35.A.305111

### **Description:**

Ultima II Super Low Profile LTE Permanent Mount

### **Features:**

LTE Cellular  
Durable PC Enclosure  
Heavy Duty Permanent (Screw) Mount  
IP67 Rated Enclosure  
Diameter:57mm  
Height: 17.4mm (Not including thread)  
Cable: 3000mm TGC-200  
Connector: SMA(M)  
RoHS & Reach Compliant

1. Introduction	3
2. Specifications	4
3. Antenna Characteristics	6
4. 2D Radiation Patterns	8
5. 3D Radiation Patterns	12
6. Mechanical Drawing	14
7. Packaging	15
<hr/>	
Changelog	16

Taoglas makes no warranties based on the accuracy or completeness of the contents of this document and reserves the right to make changes to specifications and product descriptions at any time without notice. Taoglas reserves all rights to this document and the information contained herein.

Reproduction, use or disclosure to third parties without express permission is strictly prohibited.



# 1. Introduction



The G35 Ultima II is a high-performance permanent mount wideband cellular for external use on vehicles and assets worldwide. With diameter of 57mm and at only 17.4mm in height it is one of the lowest profile LTE antennas on the market.

Taoglas strive to continuously improve and expand our product portfolio in terms of both performance and design. With this in mind, the Ultima II is an upgrade on the original form factor, designed with a profile of just 17mm - 3mm lower than the first-generation Ultima, making it one of the lowest profile external LTE antenna solutions on the market. The mounting thread size has decreased from M24 to M14 making it much easier to install. The internal antenna has also been redesigned and see great improvements in efficiency in comparison to the original Ultima design.

Typical Applications Include:

- Smart Lighting
- Smart Cities
- Connected Enterprise
- Digital Signage

The IP67 rated enclosure is made from durable UV resistant PC making it extremely light, economical for shipping and with a minimum weight impact on vehicles. This also makes it ideal for use in humid environments such as water pits or marine applications as there are no external metal parts that may corrode. The closed cell foam with double-sided adhesive provides a permanent waterproof seal and can adjust to different curvatures, stopping water from leaking under the antenna into the mounting hole.

Cables and Connectors are customizable, contact your regional Taoglas sales office for support or installation instructions.

**Note: The G35 is not suitable for mounting on a metal enclosure.**

## 2. Specifications

Electrical							
Frequency	698~806	824~894	880~960	1710~1880	1850~1990	1920~2170	2300~2690
<b>Peak Gain (dBi)</b>							
On 30x30cm Ground Plane	1.32	2.05	1.88	3.83	4.67	4.89	4.91
<b>Average Gain (dB)</b>							
On 30x30cm Ground Plane	-4.98	-3.35	-3.71	-2.76	-2.33	-2.19	-3.21
<b>Efficiency (%)</b>							
On 30x30cm Ground Plane	32.81	40.59	39.6	46.81	52.62	54.78	41.18
<b>Return Loss (dB)</b>							
On 30x30cm Ground Plane	<-4	<-10	<-6	<-7	<-6	<-6	<-4
Impedance	50Ω						
Polarization	Linear						
Radiation Pattern	Omni						
Input Power	2W max.						
Mechanical							
Dimensions	57.01mm x 17.4 mm						
Housing Material	PC						
Cable	3000mm TGC-200						
Connector	SMA(M)						
IP Rating	IP67						
Environmental							
Temperature Range	-40°C to 85°C						
Humidity	Non-condensing 65°C 95% RH						

LTE Bands			
Band Number	LTE / LTE-Advanced / WCDMA / HSPA / HSPA+ / TD-SCDMA		
	Uplink	Downlink	Covered
1	UL: 1920 to 1980	DL: 2110 to 2170	✓
2	UL: 1850 to 1910	DL: 1930 to 1990	✓
3	UL: 1710 to 1785	DL: 1805 to 1880	✓
4	UL: 1710 to 1755	DL: 2110 to 2155	✓
5	UL: 824 to 849	DL: 869 to 894	✓
7	UL: 2500 to 2570	DL: 2620 to 2690	✓
8	UL: 880 to 915	DL: 925 to 960	✓
9	UL: 1749.9 to 1784.9	DL: 1844.9 to 1879.9	✓
11	UL: 1427.9 to 1447.9	DL: 1475.9 to 1495.9	✗
12	UL: 699 to 716	DL: 729 to 746	✓
13	UL: 777 to 787	DL: 746 to 756	✓
14	UL: 788 to 798	DL: 758 to 768	✓
17	UL: 704 to 716	DL: 734 to 746	✓
18	UL: 815 to 830	DL: 860 to 875	✓
19	UL: 830 to 845	DL: 875 to 890	✓
20	UL: 832 to 862	DL: 791 to 821	✓
21	UL: 1447.9 to 1462.9	DL: 1495.9 to 1510.9	✗
22	UL: 3410 to 3490	DL: 3510 to 3590	✗
23	UL: 2000 to 2020	DL: 2180 to 2200	✓
24	UL: 1625.5 to 1660.5	DL: 1525 to 1559	✗
25	UL: 1850 to 1915	DL: 1930 to 1995	✓
26	UL: 814 to 849	DL: 859 to 894	✓
27	UL: 807 to 824	DL: 852 to 869	✓
28	UL: 703 to 748	DL: 758 to 803	✓
29	UL: -	DL: 717 to 728	✓
30	UL: 2305 to 2315	DL: 2350 to 2360	✓
31	UL: 452.5 to 457.5	DL: 462.5 to 467.5	✗
32	UL: -	DL: 1452 - 1496	✗
35		1850 to 1910	✓
38		2570 to 2620	✓
39		1880 to 1920	✓
40		2300 to 2400	✓
41		2496 to 2690	✓
42		3400 to 3600	✓
43		3600 to 3800	✗
71		617 to 698	✗

\*Covered bands represent an efficiency greater than 20%

### 3. Antenna Characteristics

#### 3.1 Return Loss

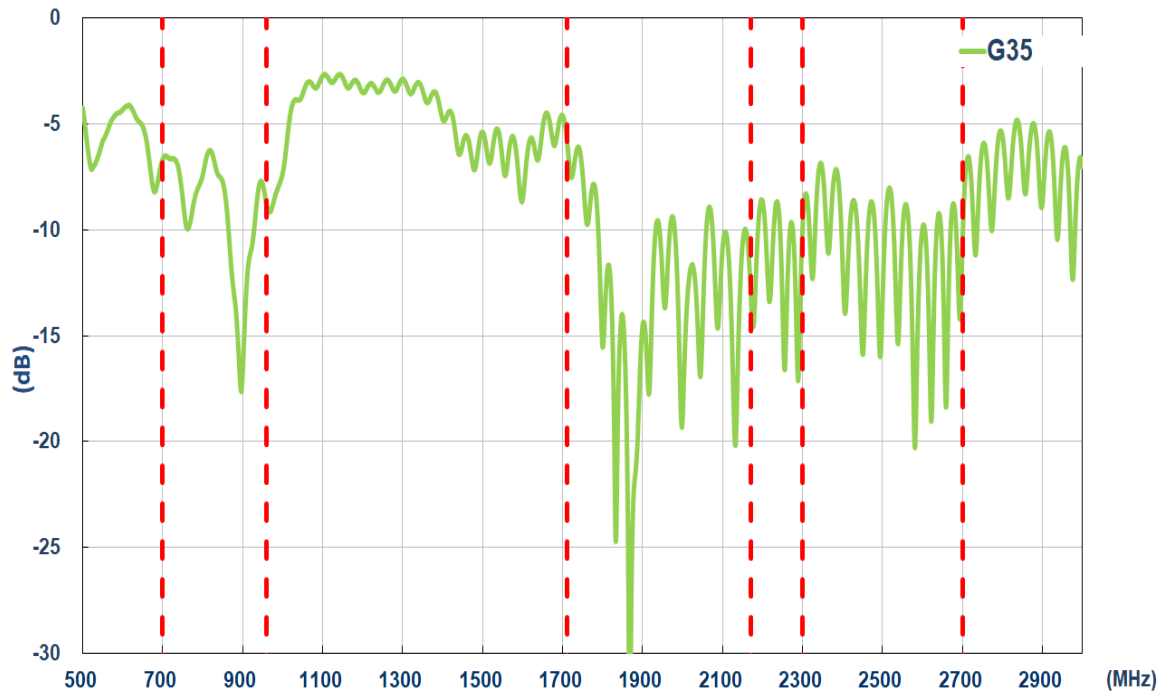

#### 3.2 Efficiency

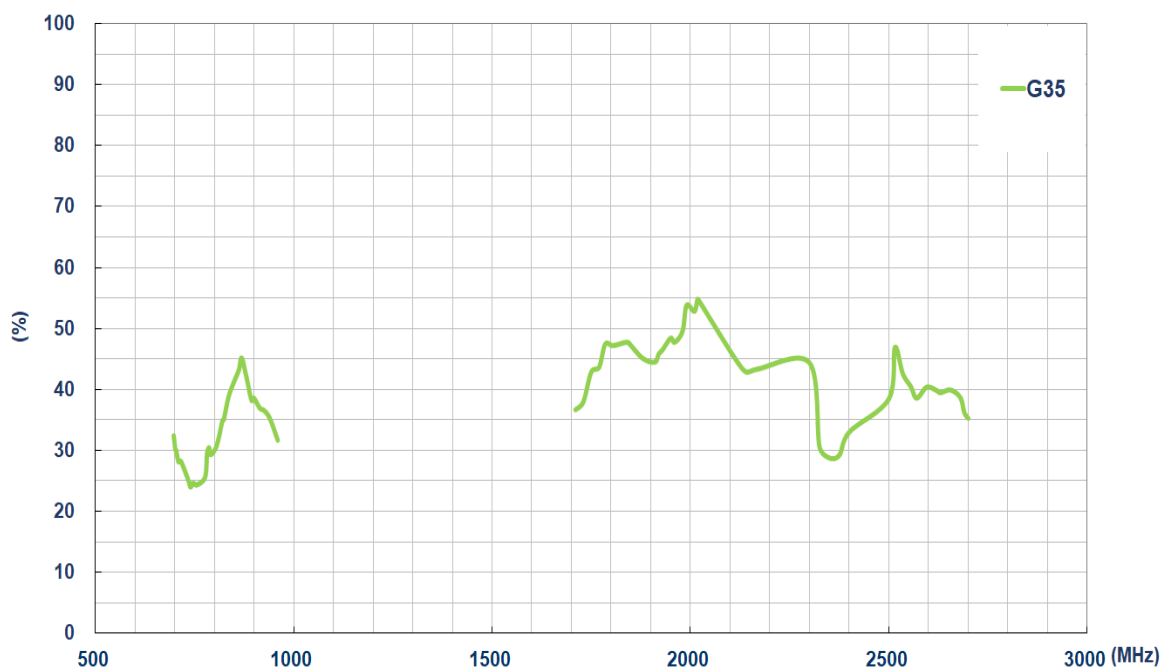

### 3.3 Average Gain

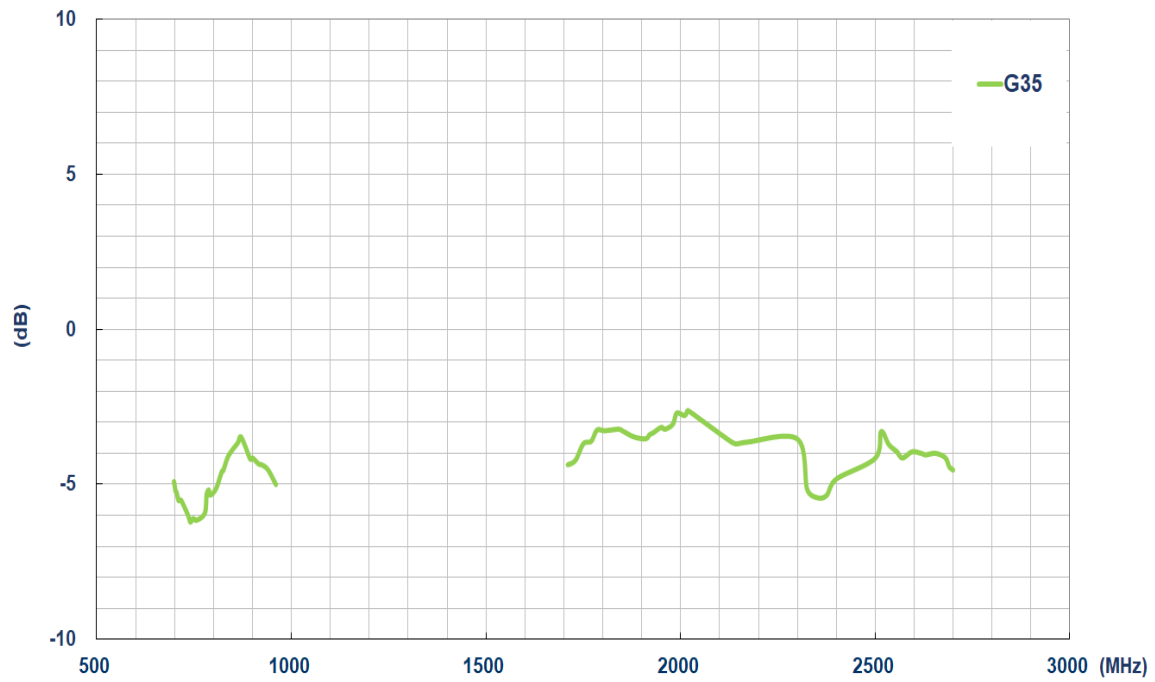

### 3.4 Peak Gain

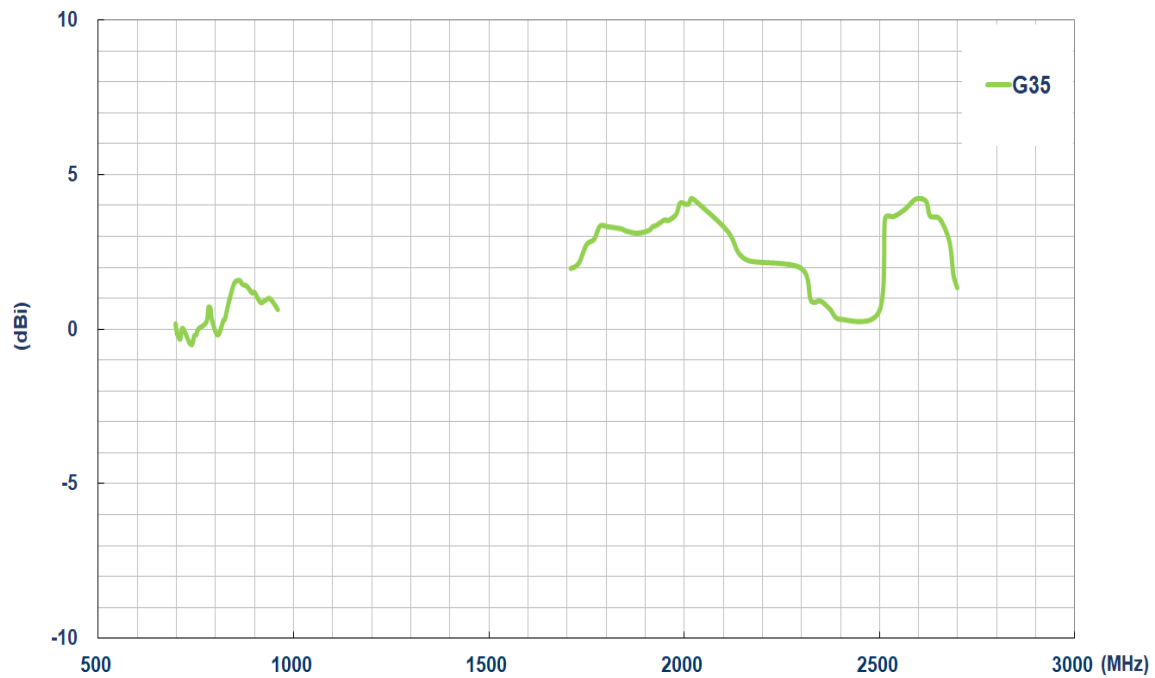

## 4. 2D Radiation Patterns

### 4.1 Test Setup

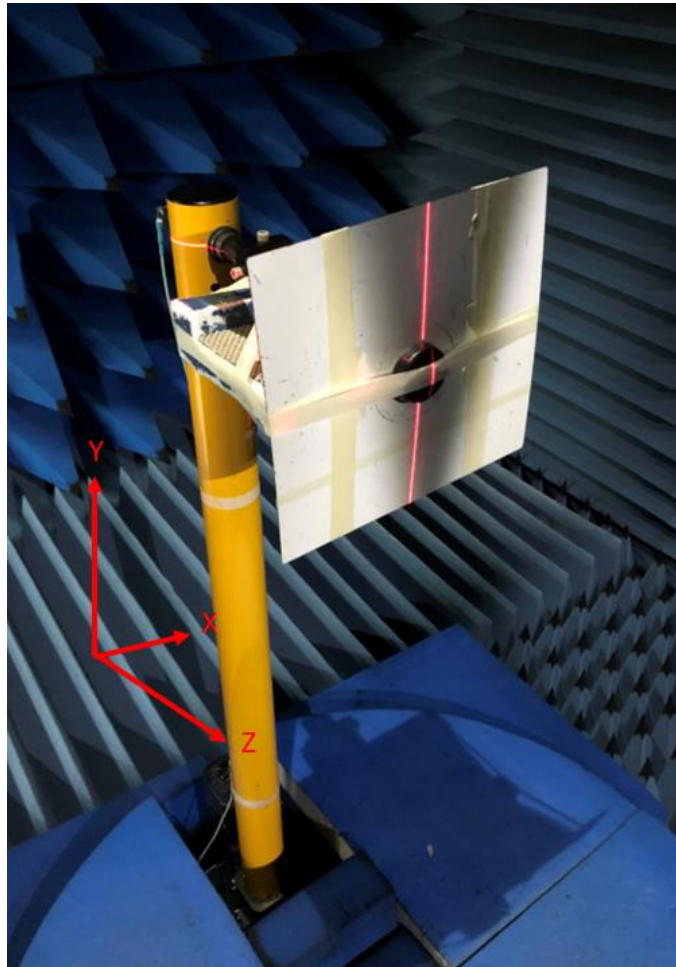

On 30x30cm Ground Plane



XY Plane

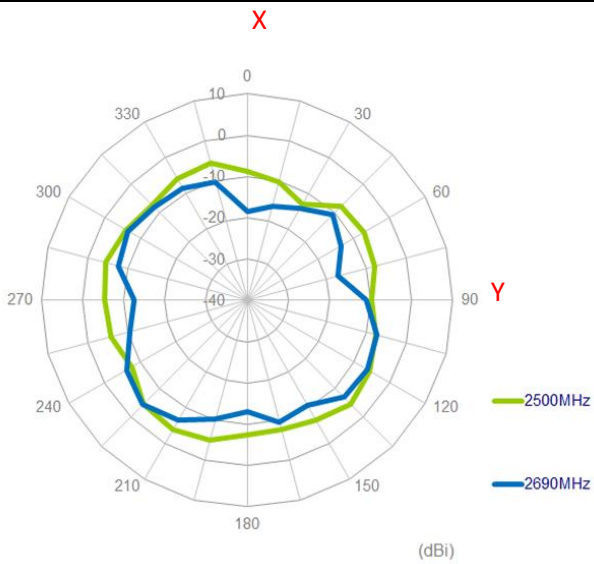
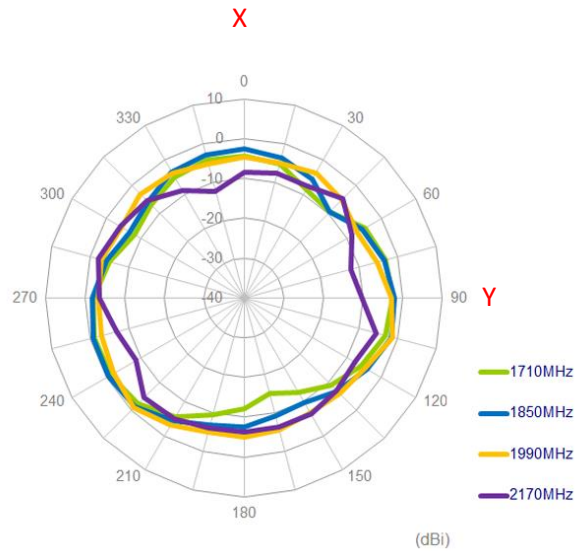
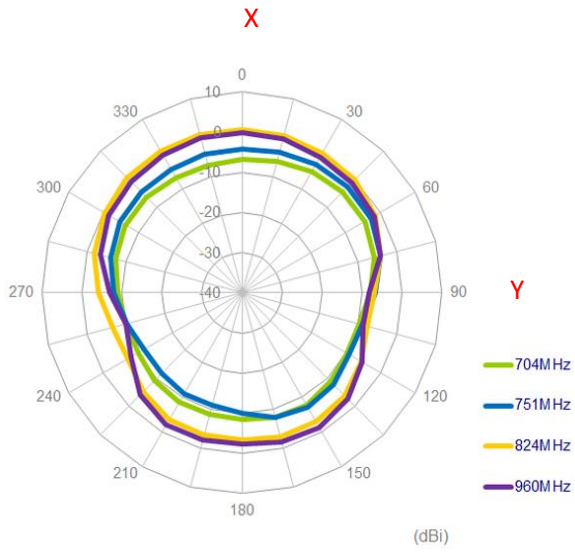

ZX Plane

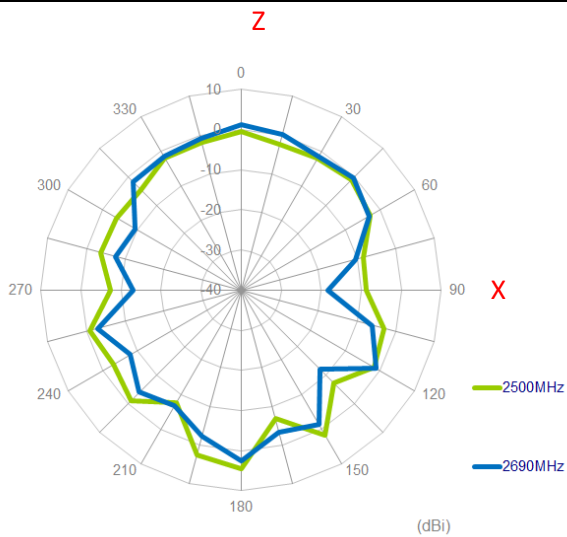
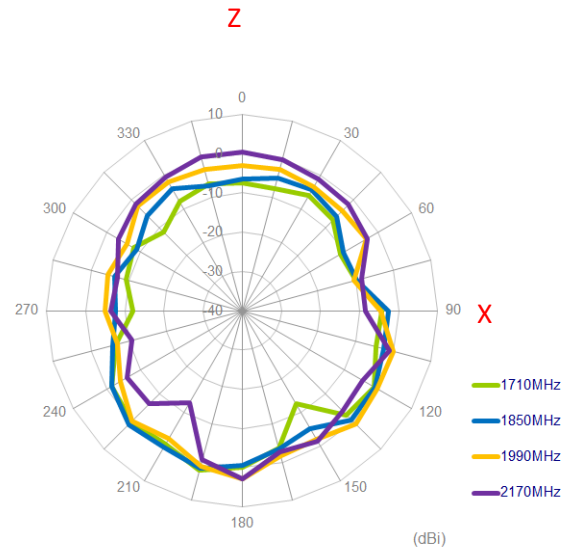
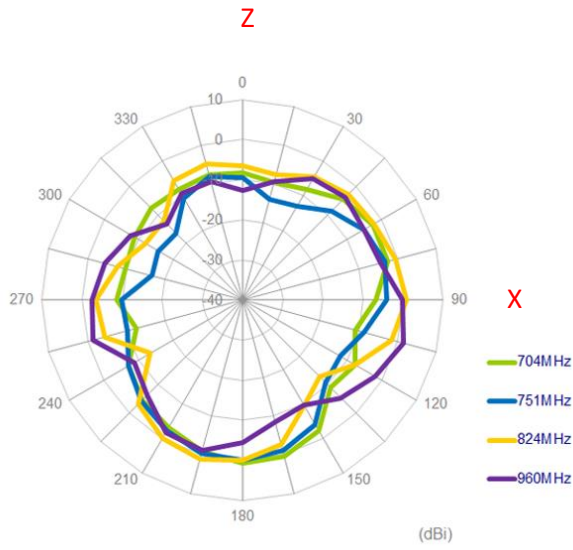

ZY Plane

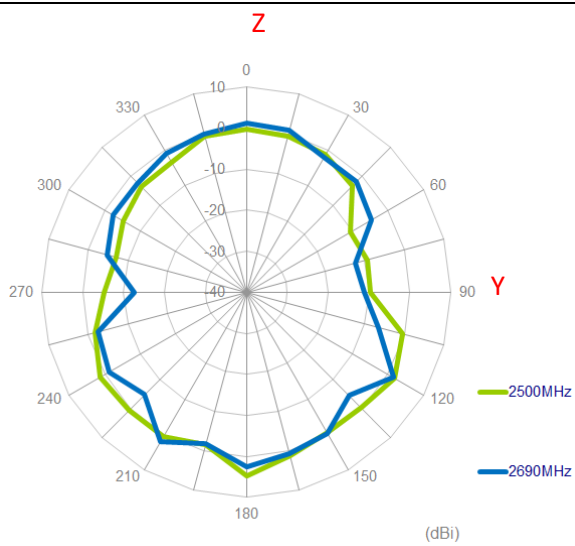
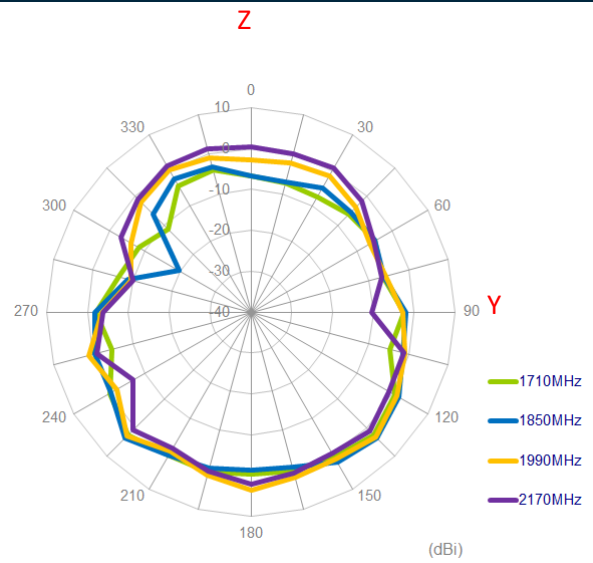
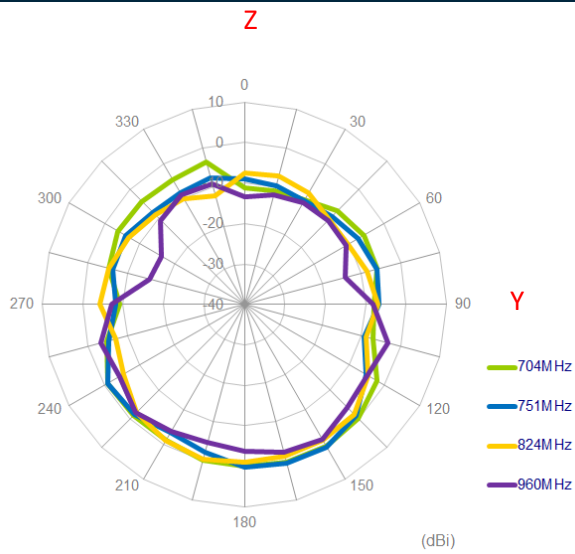

# 5. 3D Radiation Patterns

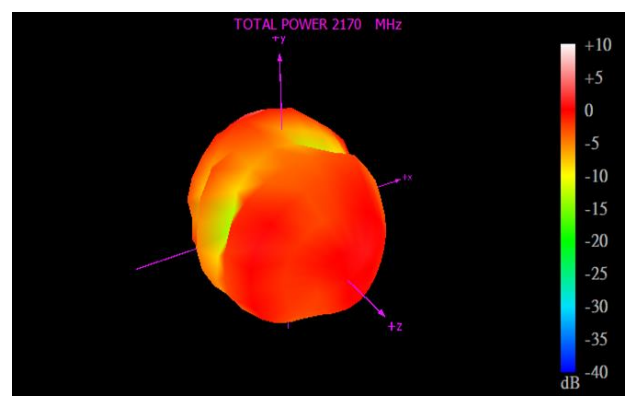
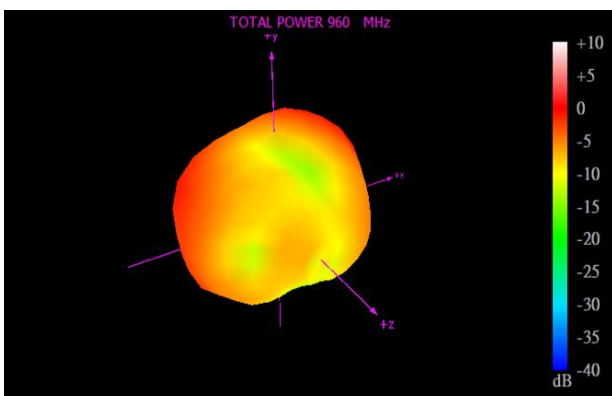
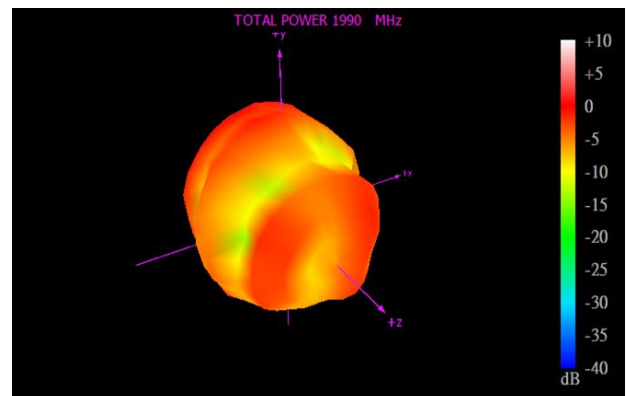
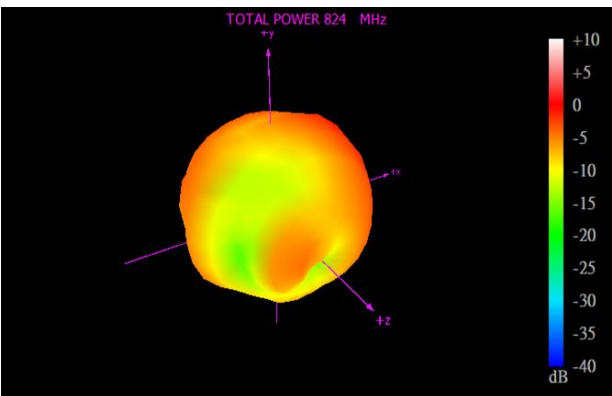
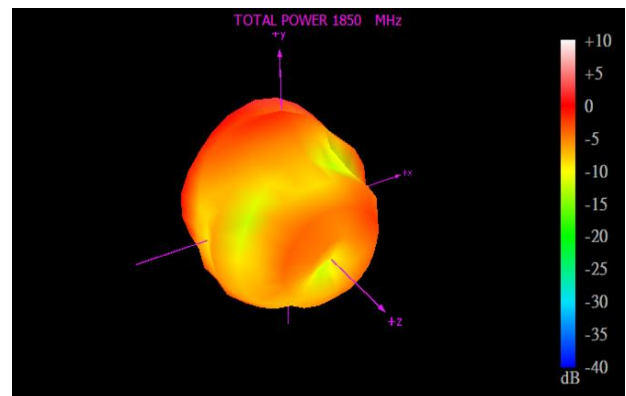
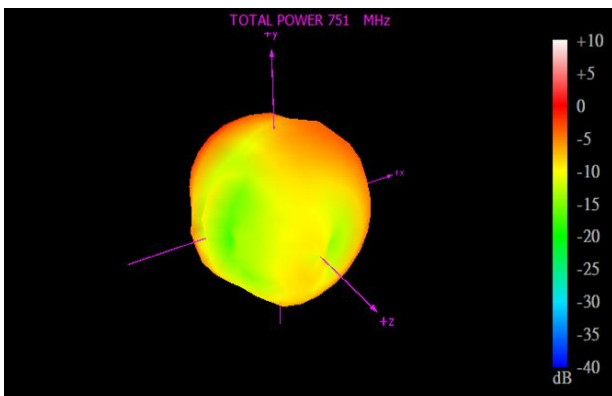
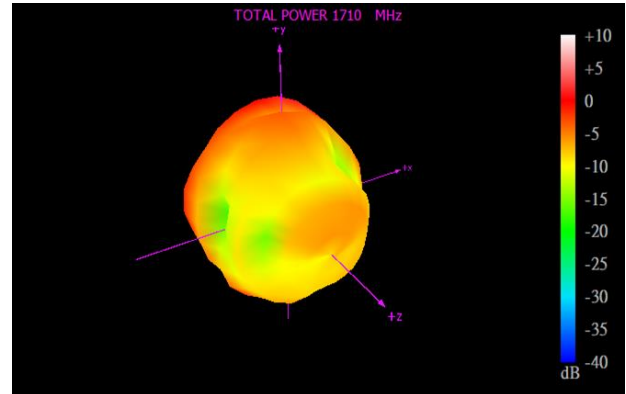
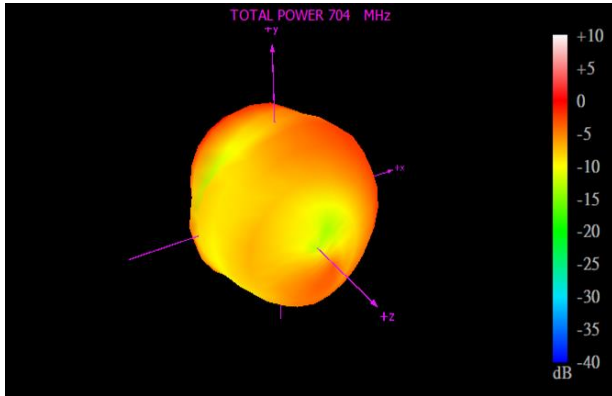

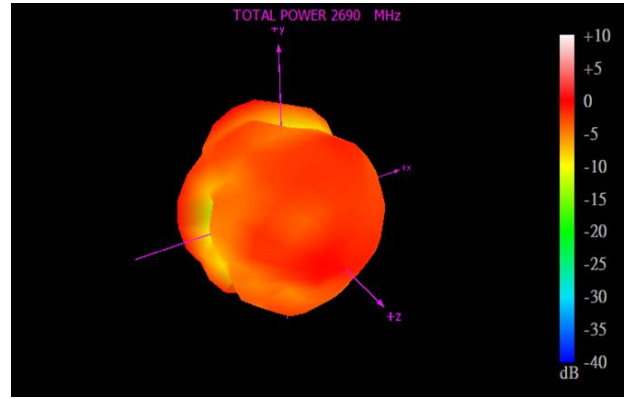
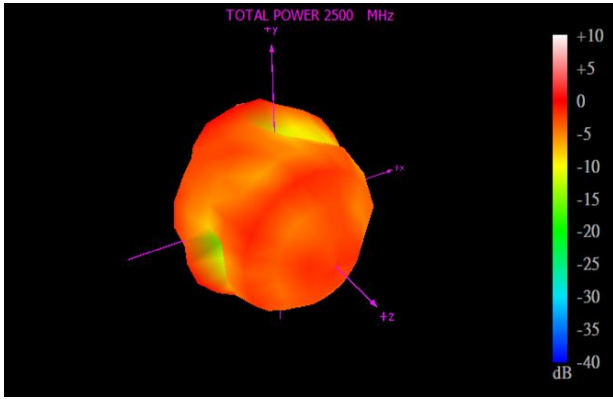

# 6. Mechanical Drawing (Units: mm)

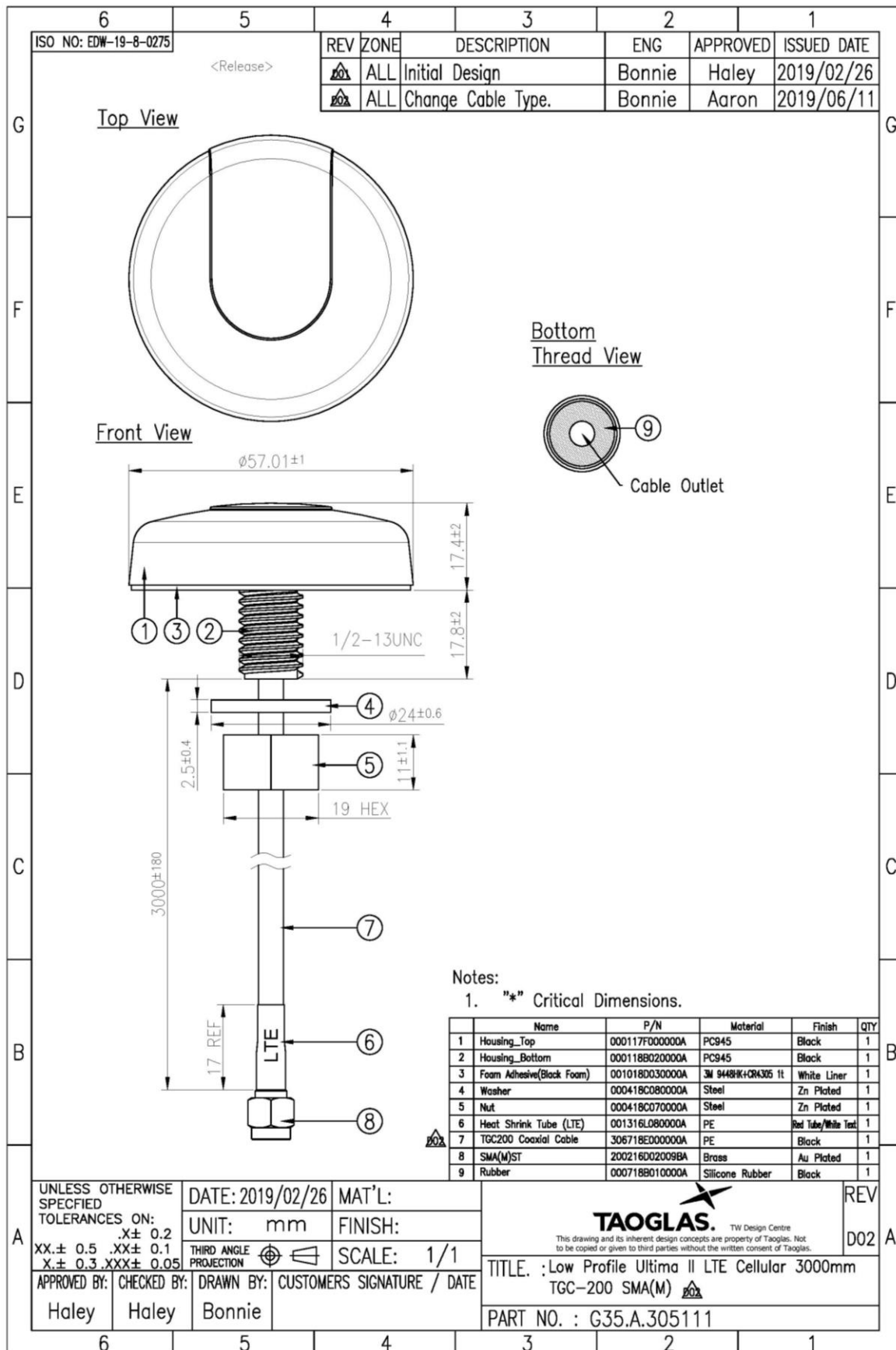

## 7. Packaging

1pcs G35.A.305111 per PE Bag  
 Dimensions - 300\*160mm  
 Weight - 160g

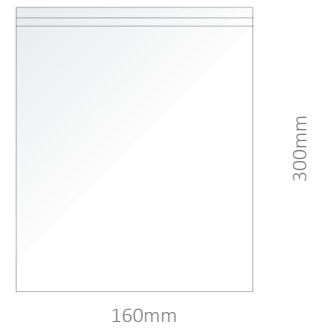

40pcs G35.A.305111 per carton  
 Dimensions - 390\*270\*330mm  
 Weight – 6.9Kg

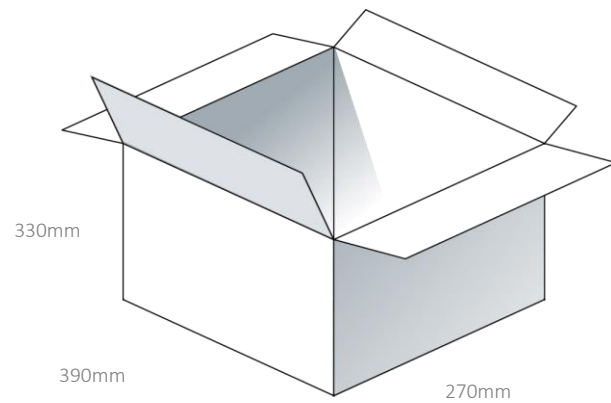

Pallet Dimensions:  
 1200\*1000\*1190mm  
 27 Cartons Per Pallet  
 9 Cartons Per Layer, 3 Layers

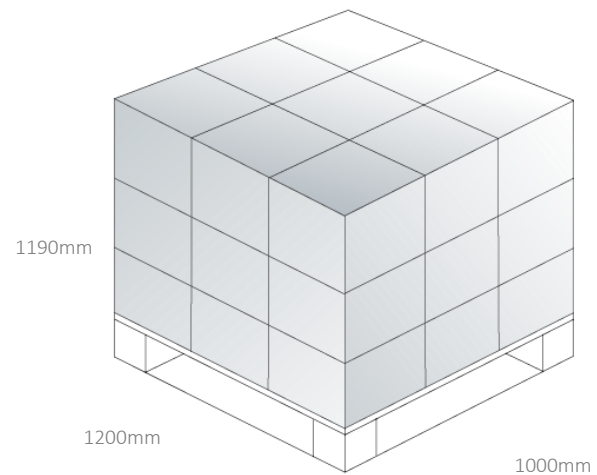

Changelog for the datasheet

**SPE-18-8-069 – G35.A.305111**

**Revision: D (Current Version)**

Date:	2019-06-06
Changes:	Updated EDW
Changes Made by:	Jack Conroy

**Previous Revisions**

**Revision: C**

Date:	2018-09-14
Changes:	Updated Part Number & Cable Type
Changes Made by:	Jack Conroy

**Revision: B**

Date:	2018-08-17
Changes:	
Changes Made by:	Jack Conroy

**Revision: A (Original First Release)**

Date:	2018-07-19
Notes:	
Author:	Jack Conroy





**TAOGLAS**®

[www.taoglas.com](http://www.taoglas.com)

