

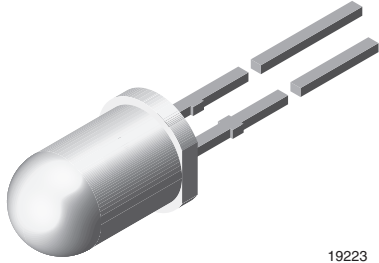

# Ultrabright LED, Ø 5 mm Untinted Non-Diffused Package



19223

## DESCRIPTION

The TLC.52.. series are a clear, non-diffused 5 mm LED for high end applications where supreme luminous intensity required.

These lamps with clear untinted plastic case utilize the highly developed ultrabright AlInGaP (AS).

The lens and the viewing angle is optimized to achieve best performance of light output and visibility.

## PRODUCT GROUP AND PACKAGE DATA

- Product group: LED
- Package: 5 mm
- Product series: power
- Angle of half intensity:  $\pm 15^\circ$

## FEATURES

- Untinted non-diffused lens
- Utilizing ultrabright AlInGaP (AS)
- High luminous intensity
- High operating temperature:  $T_j$  (chip junction temperature) up to 125 °C for AlInGaP devices
- Luminous intensity and color categorized for each packing unit
- ESD-withstand voltage: Up to 2 kV according to JESD22-A114-B
- Material categorization: For definitions of compliance please see [www.vishay.com/doc?99912](http://www.vishay.com/doc?99912)



## APPLICATIONS

- Interior and exterior lighting
- Outdoor LED panels
- Instrumentation and front panel indicators
- Central high mounted stop lights (CHMSL) for motor vehicles
- Replaces incandescent lamps
- Traffic signals
- Light guide design

PARTS TABLE														
PART	COLOR	LUMINOUS INTENSITY (mcd)			at I <sub>F</sub> (mA)	WAVELENGTH (nm)			at I <sub>F</sub> (mA)	FORWARD VOLTAGE (V)			at I <sub>F</sub> (mA)	TECHNOLOGY
		MIN.	TYP.	MAX.		MIN.	TYP.	MAX.		MIN.	TYP.	MAX.		
TLCR5200	Red	1350	4000	-	50	611	616	622	50	-	2.1	2.7	50	AllInGaP on GaAs
TLCY5200	Yellow	1350	4000	-	50	585	590	597	50	-	2.1	2.7	50	AllInGaP on GaAs

ABSOLUTE MAXIMUM RATINGS ( $T_{amb} = 25^\circ\text{C}$ , unless otherwise specified) TLCR5200, TLCY5200				
PARAMETER	TEST CONDITION	SYMBOL	VALUE	UNIT
Reverse voltage <sup>(1)</sup>		$V_R$	5	V
DC forward current	$T_{amb} \leq 85^\circ\text{C}$	$I_F$	50	mA
Surge forward current	$t_p \leq 10 \mu\text{s}$	$I_{FSM}$	1	A
Power dissipation		$P_V$	135	mW
Junction temperature		$T_j$	125	°C
Operating temperature range		$T_{amb}$	- 40 to + 100	°C
Storage temperature range		$T_{stg}$	- 40 to + 100	°C
Soldering temperature	$t \leq 5 \text{ s}$ , 2 mm from body	$T_{sd}$	260	°C
Thermal resistance junction/ambient		$R_{thJA}$	300	K/W

### Note

<sup>(1)</sup> Driving the LED in reverse direction is suitable for a short term application



OPTICAL AND ELECTRICAL CHARACTERISTICS (T <sub>amb</sub> = 25 °C, unless otherwise specified)							
TLCR5200, RED							
PARAMETER	TEST CONDITION	PART	SYMBOL	MIN.	TYP.	MAX.	UNIT
Luminous intensity <sup>(1)</sup>	I <sub>F</sub> = 50 mA	TLCR5200	I <sub>V</sub>	1350	4000	-	mcd
Dominant wavelength	I <sub>F</sub> = 50 mA		λ <sub>d</sub>	611	616	622	nm
Peak wavelength	I <sub>F</sub> = 50 mA		λ <sub>p</sub>	-	622	-	nm
Spectral bandwidth at 50 % I <sub>rel max.</sub>	I <sub>F</sub> = 50 mA		Δλ	-	18	-	nm
Angle of half intensity	I <sub>F</sub> = 50 mA		φ	-	± 15	-	deg
Forward voltage	I <sub>F</sub> = 50 mA		V <sub>F</sub>	-	2.1	2.7	V
Reverse voltage	I <sub>R</sub> = 10 μA		V <sub>R</sub>	5	-	-	V
Temperature coefficient of V <sub>F</sub>	I <sub>F</sub> = 50 mA		TC <sub>V<sub>F</sub></sub>	-	- 3.5	-	mV/K
Temperature coefficient of λ <sub>d</sub>	I <sub>F</sub> = 50 mA		TC <sub>λ<sub>d</sub></sub>	-	0.05	-	nm/K

Note

(1) In one packing unit I<sub>Vmax</sub>/I<sub>Vmin</sub>. ≤ 2.0

OPTICAL AND ELECTRICAL CHARACTERISTICS (T <sub>amb</sub> = 25 °C, unless otherwise specified)							
TLCY5200, YELLOW							
PARAMETER	TEST CONDITION	PART	SYMBOL	MIN.	TYP.	MAX.	UNIT
Luminous intensity <sup>(1)</sup>	I <sub>F</sub> = 50 mA	TLCY5200	I <sub>V</sub>	1350	4000	-	mcd
Dominant wavelength	I <sub>F</sub> = 50 mA		λ <sub>d</sub>	585	590	597	nm
Peak wavelength	I <sub>F</sub> = 50 mA		λ <sub>p</sub>	-	593	-	nm
Spectral bandwidth at 50 % I <sub>rel max.</sub>	I <sub>F</sub> = 50 mA		Δλ	-	17	-	nm
Angle of half intensity	I <sub>F</sub> = 50 mA		φ	-	± 15	-	deg
Forward voltage	I <sub>F</sub> = 50 mA		V <sub>F</sub>	-	2.1	2.7	V
Reverse voltage	I <sub>R</sub> = 10 μA		V <sub>R</sub>	5	-	-	V
Temperature coefficient of V <sub>F</sub>	I <sub>F</sub> = 50 mA		TC <sub>V<sub>F</sub></sub>	-	- 3.5	-	mV/K
Temperature coefficient of λ <sub>d</sub>	I <sub>F</sub> = 50 mA		TC <sub>λ<sub>d</sub></sub>	-	0.1	-	nm/K

Note

(1) In one packing unit I<sub>Vmax</sub>/I<sub>Vmin</sub>. ≤ 2.0

LUMINOUS INTENSITY CLASSIFICATION			
GROUP	LIGHT INTENSITY (mcd)		
	STANDARD	MIN.	MAX.
FF	1350	2700	
GG	1800	3600	
HH	2400	4800	
II	3200	6400	
KK	4300	8600	
LL	5750	11 500	
MM	7500	15 000	
NN	10 000	20 000	
PP	13 500	27 000	
QQ	18 000	36 000	
RR	24 000	48 000	
SS	32 000	64 000	
TT	43 000	86 000	
UU	57 500	115 000	

Note

- Luminous intensity is tested at a current pulse duration of 25 ms. The type numbers represent the order groups which include only a few brightness groups. Only one group will be shipped on each bag (there will be no mixing of two groups on each bag). In order to ensure availability, single brightness groups will not be orderable. In a similar manner for colors where wavelength groups are measured and binned, single wavelength groups will be shipped in any one bag. In order to ensure availability, single wavelength groups will not be orderable.

COLOR CLASSIFICATION				
GROUP	DOM. WAVELENGTH (nm)			
	YELLOW		RED	
	MIN.	MAX.	MIN.	MAX.
0	585	588		
1	587	591	611	618
2	589	594	614	622
3	592	597		

Note

- Wavelengths are tested at a current pulse duration of 25 ms.

**TYPICAL CHARACTERISTICS** ( $T_{amb} = 25\text{ }^{\circ}\text{C}$ , unless otherwise specified)

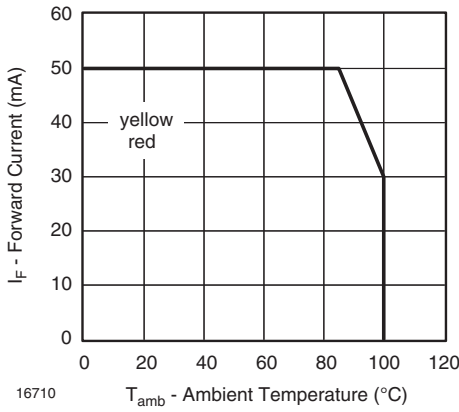

Fig. 1 - Forward Current vs. Ambient Temperature

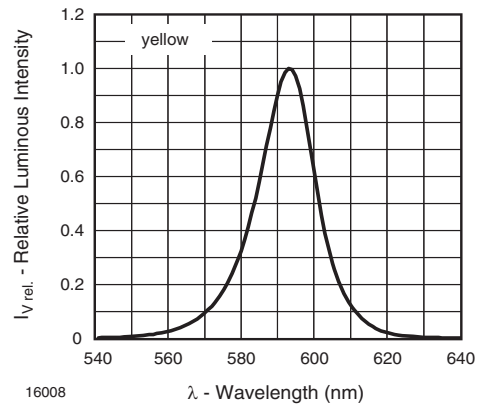

Fig. 4 - Relative Intensity vs. Wavelength

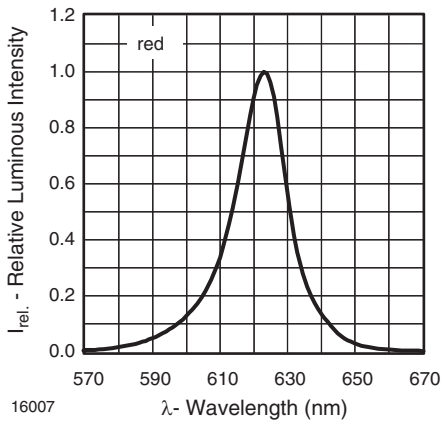

Fig. 2 - Relative Intensity vs. Wavelength

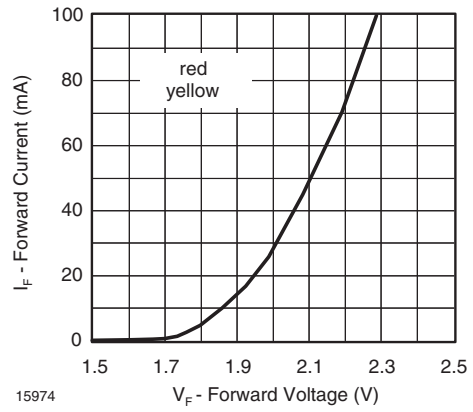

Fig. 5 - Forward Current vs. Forward Voltage

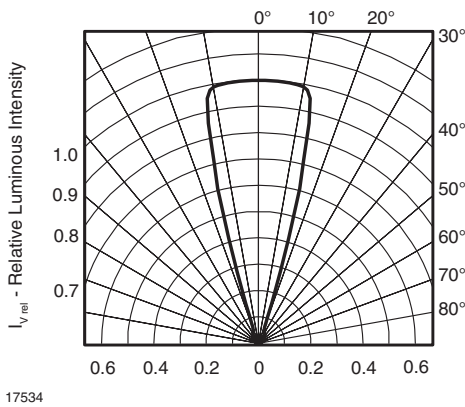

Fig. 3 - Relative Intensity vs. Angular Displacement

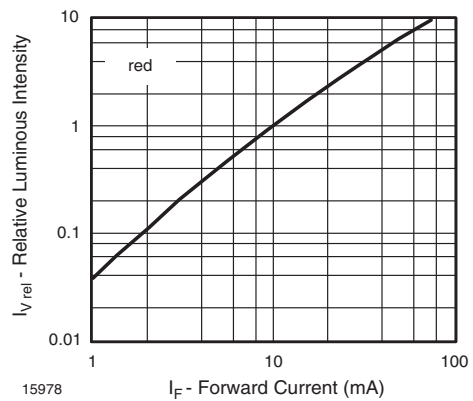

Fig. 6 - Relative Luminous Flux vs. Forward Current

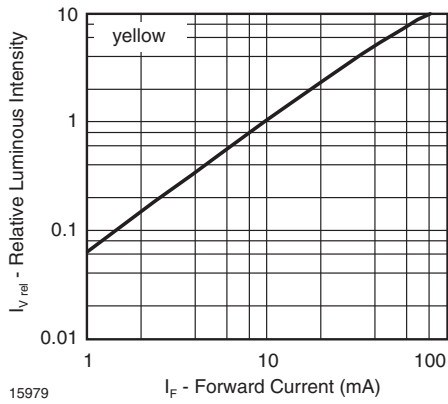
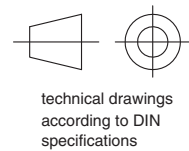
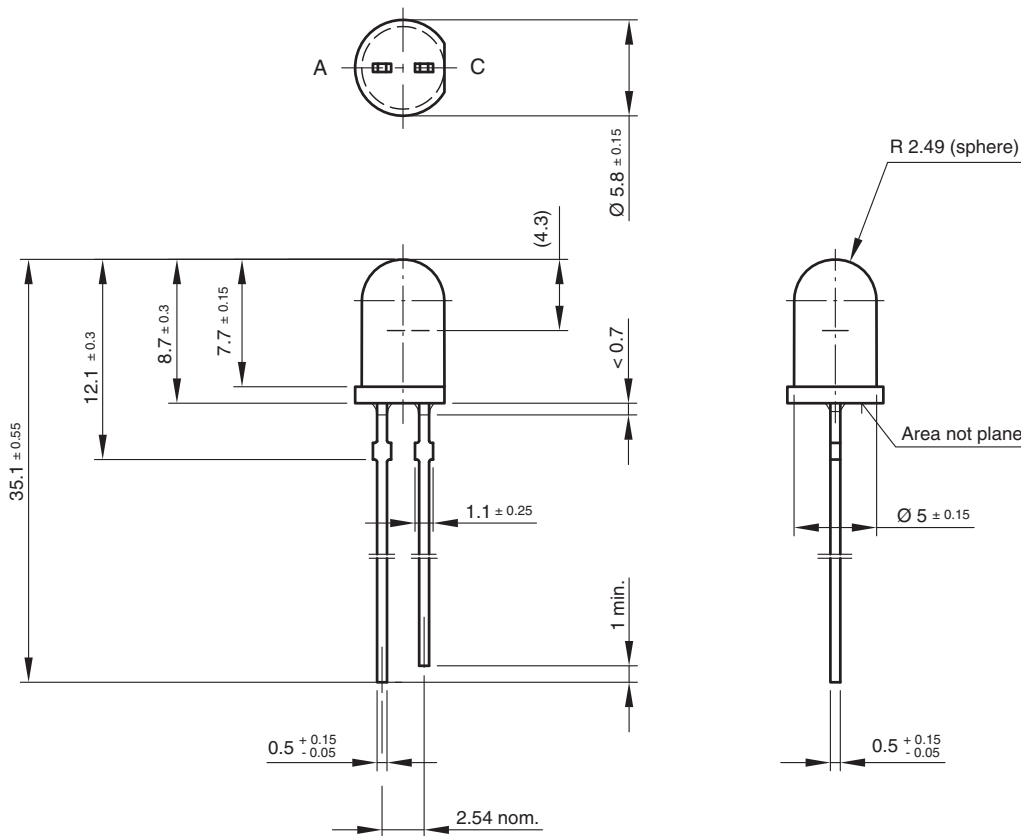

Fig. 7 - Relative Luminous Flux vs. Forward Current

**PACKAGE DIMENSIONS** in millimeters



Drawing-No.: 6.544-5258.07-4

Issue: 4; 19.05.09

14339



## **Disclaimer**

ALL PRODUCT, PRODUCT SPECIFICATIONS AND DATA ARE SUBJECT TO CHANGE WITHOUT NOTICE TO IMPROVE RELIABILITY, FUNCTION OR DESIGN OR OTHERWISE.

Vishay Intertechnology, Inc., its affiliates, agents, and employees, and all persons acting on its or their behalf (collectively, "Vishay"), disclaim any and all liability for any errors, inaccuracies or incompleteness contained in any datasheet or in any other disclosure relating to any product.

Vishay makes no warranty, representation or guarantee regarding the suitability of the products for any particular purpose or the continuing production of any product. To the maximum extent permitted by applicable law, Vishay disclaims (i) any and all liability arising out of the application or use of any product, (ii) any and all liability, including without limitation special, consequential or incidental damages, and (iii) any and all implied warranties, including warranties of fitness for particular purpose, non-infringement and merchantability.

Statements regarding the suitability of products for certain types of applications are based on Vishay's knowledge of typical requirements that are often placed on Vishay products in generic applications. Such statements are not binding statements about the suitability of products for a particular application. It is the customer's responsibility to validate that a particular product with the properties described in the product specification is suitable for use in a particular application. Parameters provided in datasheets and / or specifications may vary in different applications and performance may vary over time. All operating parameters, including typical parameters, must be validated for each customer application by the customer's technical experts. Product specifications do not expand or otherwise modify Vishay's terms and conditions of purchase, including but not limited to the warranty expressed therein.

Except as expressly indicated in writing, Vishay products are not designed for use in medical, life-saving, or life-sustaining applications or for any other application in which the failure of the Vishay product could result in personal injury or death. Customers using or selling Vishay products not expressly indicated for use in such applications do so at their own risk. Please contact authorized Vishay personnel to obtain written terms and conditions regarding products designed for such applications.

No license, express or implied, by estoppel or otherwise, to any intellectual property rights is granted by this document or by any conduct of Vishay. Product names and markings noted herein may be trademarks of their respective owners.