

## Data sheet | Item number: 285-181

2-conductor through terminal block; 95 mm<sup>2</sup>; lateral marker slots; with fixing flanges; POWER CAGE CLAMP; 95,00 mm<sup>2</sup>; gray



[www.wago.com/285-181](http://www.wago.com/285-181)



Color:

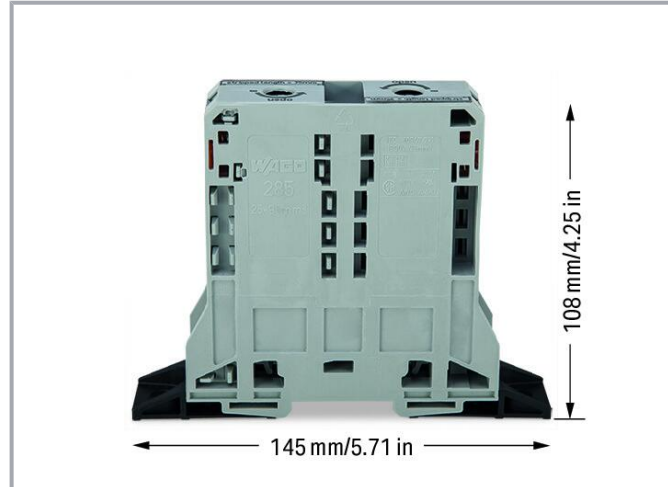

### Data

#### Electrical data

#### Ratings per IEC/EN

Ratings per	IEC/EN 60947-7-1
Nominal voltage (III/3)	1000 V
Rated impulse voltage (III/3)	12 kV
Rated current	232 A
Legend (ratings)	(III / 3) ≙ Overvoltage category III / Pollution degree 3

#### Ratings per IEC/EN 2

Rated voltage (III/3) 2	1500 V
Rated surge voltage (III/3) 2	12 kV

Subject to changes. Please also observe the further product documentation!

WAGO GmbH & Co. KG  
Hansastr. 27  
32423 Minden  
Phone: +49571 887-0 | Fax: +49571 887-169  
Email: [info.de@wago.com](mailto:info.de@wago.com) | Web: [www.wago.com](http://www.wago.com)

Do you have any questions about our products?  
We are always happy to take your call at +49 (571) 887-44222.



## Ratings per UL 1059

Approvals per	UL 1059
Rated voltage UL (Use Group B)	600 V
Rated current UL (Use Group B)	200 A
Rated voltage UL (Use Group C)	600 V
Rated current UL (Use Group C)	200 A

## Ratings per CSA

Approvals per	CSA 22.2 No 158
Rated voltage CSA (Use Group B)	1000 V
Rated current CSA (Use Group B)	210 A
Rated voltage CSA (Use Group C)	1000 V
Rated current CSA (Use Group D)	210 A

## Power loss

Power loss, per pole (potential)	7.535 W
Rated current $I_N$ for specified power loss	232 A
Resistance value for specified, current-dependent power loss	0 $\Omega$

## General

Voltage type 1	AC/DC
Voltage type 2	DC

## Connection data

Connection points	2
Total number of potentials	1
Number of levels	1
Number of jumper slots	2

## Connection 1

Connection technology	POWER CAGE CLAMP
Actuation type	T-wrench; 8 mm
Connectable conductor materials	Copper
Solid conductor	25 ... 95 mm <sup>2</sup> / 4 ... 4/0 AWG

Subject to changes. Please also observe the further product documentation!



Stranded conductor	25 ... 95 mm <sup>2</sup> / 4 ... 4/0 AWG
Fine-stranded conductor	25 ... 95 mm <sup>2</sup> / 4 ... 4/0 AWG
Fine-stranded conductor; with insulated ferrule	25 ... 95 mm <sup>2</sup> / 4 ... 4/0 AWG
Fine-stranded conductor; with uninsulated ferrule	25 ... 95 mm <sup>2</sup> / 4 ... 4/0 AWG
Strip length	35 mm / 1.38 inches
Wiring direction	Side-entry wiring

### Physical data

Width	25 mm / 0.984 inches
Height from the surface	108 mm / 4.252 inches
Depth	145 mm / 5.709 inches

### Mechanical Data

Mounting type	Mounting flange
Marking level	Side marking

### Material Data

Note (material data)	Information on material specifications can be found here
Color	gray
Material group	I
Insulation material	Polyamide (PA66)
Flammability class per UL94	V0
Fire load	3.782 MJ
Weight	266 g

### Environmental requirements

Processing temperature	-35 ... +85 °C
Continuous operating temperature	-60 ... +105 °C

### Commercial data

eCl@ss 10.0	27-14-11-20
eCl@ss 9.0	27-14-11-20
ETIM 8.0	EC000897
ETIM 7.0	EC000897
PU (SPU)	5 pcs

Subject to changes. Please also observe the further product documentation!





Packaging type	box
Country of origin	PL
GTIN	4055143583930
Customs tariff number	85369010000

## Environmental Product Compliance



RoHS Compliance Status	Compliant, No Exemption
------------------------	-------------------------

## Approvals / Certificates

### General approvals

Logo	Approval	Additional Approval Text	Certificate name
	CCA DEKRA Certification B.V.	EN 60947	NTR NL-7707
	CSA DEKRA Certification B.V.	C22.2	154112
	KEMA/KEUR DEKRA Certification B.V.	EN 60947	71-105562
	UL Underwriters Laboratories Inc.	UL 1059	E45172

### Declarations of conformity and manufacturer's declarations



Logo	Approval	Additional Approval Text	Certificate name
	EU-Declaration of Conformity WAGO GmbH & Co. KG	-	-
	UK-Declaration of Conformity WAGO GmbH & Co. KG	-	-

### Approvals for marine applications

Subject to changes. Please also observe the further product documentation!





WAGO GmbH & Co. KG  
Hansastr. 27  
32423 Minden  
Phone: +49571 887-0 | Fax: +49571 887-169  
Email: [info.de@wago.com](mailto:info.de@wago.com) | Web: [www.wago.com](http://www.wago.com)

Do you have any questions about our products?  
We are always happy to take your call at +49 (571) 887-44222.



Logo	Approval	Additional Approval Text	Certificate name
	<b>ABS</b> American Bureau of Shipping	EN 60947	20- HG1941090- PDA
	<b>DNV GL</b> Det Norske Veritas, Germanischer Lloyd	-	TAE00001V2

## Optional accessories

### Ferrule

Ferrule		
	<b>Item no.: 216-413</b> Ferrule; Sleeve for 25 mm <sup>2</sup> / AWG 4; uninsulated; electro-tin plated; electrolytic copper; gastight crimped; acc. to DIN 46228, Part 1/08.92; silver-colored	<a href="http://www.wago.com/216-413">www.wago.com/216-413</a>
	<b>Item no.: 216-414</b> Ferrule; Sleeve for 35 mm <sup>2</sup> / AWG 2; uninsulated; electro-tin plated; electrolytic copper; gastight crimped; acc. to DIN 46228, Part 1/08.92; silver-colored	<a href="http://www.wago.com/216-414">www.wago.com/216-414</a>
	<b>Item no.: 216-425</b> Ferrule; Sleeve for 50 mm <sup>2</sup> / AWG 1; uninsulated; electro-tin plated; electrolytic copper; gastight crimped; acc. to DIN 46228, Part 1/08.92	<a href="http://www.wago.com/216-425">www.wago.com/216-425</a>
	<b>Item no.: 216-424</b> Ferrule; Sleeve for 35 mm <sup>2</sup> / AWG 2; uninsulated; electro-tin plated; electrolytic copper; gastight crimped; acc. to DIN 46228, Part 1/08.92; silver-colored	<a href="http://www.wago.com/216-424">www.wago.com/216-424</a>
	<b>Item no.: 216-435</b> Ferrule; Sleeve for 50 mm <sup>2</sup> / AWG 1; uninsulated; electro-tin plated; electrolytic copper; gastight crimped; acc. to DIN 46228, Part 1/08.92	<a href="http://www.wago.com/216-435">www.wago.com/216-435</a>













### Protective warning marker

Cover		
	<b>Item no.: 285-170</b> Protective warning marker; with high-voltage symbol, black; yellow	<a href="http://www.wago.com/285-170">www.wago.com/285-170</a>
	<b>Item no.: 285-175</b> Protective warning marker; yellow	<a href="http://www.wago.com/285-175">www.wago.com/285-175</a>

### Marking accessories

Marker carrier		
	<b>Item no.: 285-442</b> Adaptor; gray	<a href="http://www.wago.com/285-442">www.wago.com/285-442</a>
Marker		

Subject to changes. Please also observe the further product documentation!

	<b>Item no.: 2009-115/000-002</b> WMB-Inline; for Smart Printer; 1500 pieces on roll; stretchable 5 - 5.2 mm; plain; snap-on type; yellow	<a href="http://www.wago.com/2009-115/000-002">www.wago.com/2009-115/000-002</a>
	<b>Item no.: 2009-115/000-007</b> WMB-Inline; for Smart Printer; 1500 pieces on roll; stretchable 5 - 5.2 mm; plain; snap-on type; gray	<a href="http://www.wago.com/2009-115/000-007">www.wago.com/2009-115/000-007</a>
	<b>Item no.: 2009-115/000-017</b> WMB-Inline; for Smart Printer; 1500 pieces on roll; stretchable 5 - 5.2 mm; plain; snap-on type; light green	<a href="http://www.wago.com/2009-115/000-017">www.wago.com/2009-115/000-017</a>
	<b>Item no.: 2009-115/000-023</b> WMB-Inline; for Smart Printer; 1500 pieces on roll; stretchable 5 - 5.2 mm; plain; snap-on type; green	<a href="http://www.wago.com/2009-115/000-023">www.wago.com/2009-115/000-023</a>
	<b>Item no.: 2009-115/000-024</b> WMB-Inline; for Smart Printer; 1500 pieces on roll; stretchable 5 - 5.2 mm; plain; snap-on type; violet	<a href="http://www.wago.com/2009-115/000-024">www.wago.com/2009-115/000-024</a>
	<b>Item no.: 2009-115</b> WMB-Inline; for Smart Printer; 1500 pieces on roll; stretchable 5 - 5.2 mm; plain; snap-on type; white	<a href="http://www.wago.com/2009-115">www.wago.com/2009-115</a>
	<b>Item no.: 793-5501/000-007</b> WMB marking card; as card; for terminal block width 5 - 17.5 mm; stretchable 5 - 5.2 mm; plain; snap-on type; gray	<a href="http://www.wago.com/793-5501/000-007">www.wago.com/793-5501/000-007</a>
	<b>Item no.: 793-5501/000-012</b> WMB marking card; as card; for terminal block width 5 - 17.5 mm; stretchable 5 - 5.2 mm; plain; snap-on type; orange	<a href="http://www.wago.com/793-5501/000-012">www.wago.com/793-5501/000-012</a>
	<b>Item no.: 793-5501/000-014</b> WMB marking card; as card; for terminal block width 5 - 17.5 mm; stretchable 5 - 5.2 mm; plain; snap-on type; brown	<a href="http://www.wago.com/793-5501/000-014">www.wago.com/793-5501/000-014</a>
	<b>Item no.: 793-5501/000-017</b> WMB marking card; as card; for terminal block width 5 - 17.5 mm; stretchable 5 - 5.2 mm; plain; snap-on type; light green	<a href="http://www.wago.com/793-5501/000-017">www.wago.com/793-5501/000-017</a>
	<b>Item no.: 793-5501/000-023</b> WMB marking card; as card; for terminal block width 5 - 17.5 mm; stretchable 5 - 5.2 mm; plain; snap-on type; green	<a href="http://www.wago.com/793-5501/000-023">www.wago.com/793-5501/000-023</a>
	<b>Item no.: 793-5501/000-024</b> WMB marking card; as card; for terminal block width 5 - 17.5 mm; stretchable 5 - 5.2 mm; plain; snap-on type; violet	<a href="http://www.wago.com/793-5501/000-024">www.wago.com/793-5501/000-024</a>

Subject to changes. Please also observe the further product documentation!



**Item no.: 793-501/000-002**  
WMB marking card; as card; not stretchable; plain; snap-on type; yellow

[www.wago.com/793-501/000-002](http://www.wago.com/793-501/000-002)



**Item no.: 793-501/000-007**  
WMB marking card; as card; not stretchable; plain; snap-on type; gray

[www.wago.com/793-501/000-007](http://www.wago.com/793-501/000-007)



**Item no.: 793-501/000-017**  
WMB marking card; as card; not stretchable; plain; snap-on type; light green

[www.wago.com/793-501/000-017](http://www.wago.com/793-501/000-017)



**Item no.: 793-501/000-012**  
WMB marking card; as card; not stretchable; plain; snap-on type; orange

[www.wago.com/793-501/000-012](http://www.wago.com/793-501/000-012)



**Item no.: 793-501/000-023**  
WMB marking card; as card; not stretchable; plain; snap-on type; green

[www.wago.com/793-501/000-023](http://www.wago.com/793-501/000-023)



**Item no.: 793-501/000-006**  
WMB marking card; as card; not stretchable; plain; snap-on type; blue

[www.wago.com/793-501/000-006](http://www.wago.com/793-501/000-006)



**Item no.: 793-501/000-005**  
WMB marking card; as card; not stretchable; plain; snap-on type; red

[www.wago.com/793-501/000-005](http://www.wago.com/793-501/000-005)



**Item no.: 793-501**  
WMB marking card; as card; not stretchable; plain; snap-on type; white

[www.wago.com/793-501](http://www.wago.com/793-501)



**Item no.: 793-501/000-024**  
WMB marking card; as card; not stretchable; plain; snap-on type; violet

[www.wago.com/793-501/000-024](http://www.wago.com/793-501/000-024)



**Item no.: 793-5501/000-005**  
WMB marking card; as card; for terminal block width 5 - 17.5 mm; stretchable 5 - 5.2 mm; plain; snap-on type; red

[www.wago.com/793-5501/000-005](http://www.wago.com/793-5501/000-005)



**Item no.: 793-5501/000-002**  
WMB marking card; as card; for terminal block width 5 - 17.5 mm; stretchable 5 - 5.2 mm; plain; snap-on type; yellow

[www.wago.com/793-5501/000-002](http://www.wago.com/793-5501/000-002)

Subject to changes. Please also observe the further product documentation!



**Item no.: 793-5501/000-006**

WMB marking card; as card; for terminal block width 5 - 17.5 mm; stretchable 5 - 5.2 mm; plain; snap-on type; blue [www.wago.com/793-5501/000-006](http://www.wago.com/793-5501/000-006)



**Item no.: 793-5501**

WMB marking card; as card; for terminal block width 5 - 17.5 mm; stretchable 5 - 5.2 mm; plain; snap-on type; white [www.wago.com/793-5501](http://www.wago.com/793-5501)



**Item no.: 2009-115/000-012**

WMB-Inline; for Smart Printer; 1500 pieces on roll; stretchable 5 - 5.2 mm; plain; snap-on type; orange [www.wago.com/2009-115/000-012](http://www.wago.com/2009-115/000-012)



**Item no.: 2009-115/000-006**

WMB-Inline; for Smart Printer; 1500 pieces on roll; stretchable 5 - 5.2 mm; plain; snap-on type; blue [www.wago.com/2009-115/000-006](http://www.wago.com/2009-115/000-006)



**Item no.: 2009-115/000-005**

WMB-Inline; for Smart Printer; 1500 pieces on roll; stretchable 5 - 5.2 mm; plain; snap-on type; red [www.wago.com/2009-115/000-005](http://www.wago.com/2009-115/000-005)

Group marker carrier



**Item no.: 249-105**

Group marker carrier; gray [www.wago.com/249-105](http://www.wago.com/249-105)

Jumpers

Jumper



**Item no.: 285-495**

Jumper; insulated; gray [www.wago.com/285-495](http://www.wago.com/285-495)

Cover

Cover



**Item no.: 285-169**

Finger guard; touchproof cover protects unused conductor entries and jumper slots; for 95 mm<sup>2</sup> high-current tbs; yellow [www.wago.com/285-169](http://www.wago.com/285-169)

Tool

Operating tool



**Item no.: 285-172**

Allen wrench; with a partially insulated shaft; green [www.wago.com/285-172](http://www.wago.com/285-172)



**Item no.: 285-173**

Allen wrench; with a partially insulated shaft; with anti-rotation protection; green [www.wago.com/285-173](http://www.wago.com/285-173)

Mounting

Mounting accessories

Subject to changes. Please also observe the further product documentation!





Item no.: 285-168

Fixing element; for 95 mm<sup>2</sup> high-current terminal blocks; orange

[www.wago.com/285-168](http://www.wago.com/285-168)

### Current and Voltage Taps

Current and voltage tap



Item no.: 855-951/250-000

Current and voltage tap up to 95 mm<sup>2</sup>; Primary rated current: 250 A; Secondary rated current: 1 A; Rated power: 0.2 VA; Accuracy class: 0.5; fused

[www.wago.com/855-951/250-000](http://www.wago.com/855-951/250-000)

### Voltage tap

Power tap



Item no.: 285-407

Power tap; for 95 mm<sup>2</sup> high-current tbs; 10,00 mm<sup>2</sup>; gray

[www.wago.com/285-407](http://www.wago.com/285-407)

## Downloads

### Documentation

#### Bid Text

285-181 X81 - Datei	2019 Feb 19	xml 3.3 kB	Download
285-181 doc - Datei	2018 Jan 4	doc 24.1 kB	Download

#### Additional Information

Technical Section Technical explanations		pdf 2.2 MB	Download
---	--	---------------	----------

## CAD/CAE-Data

### CAD data

2D/3D Models 285-181		URL	Download
----------------------	--	-----	----------

### CAE data

ZUKEN Portal 285-181		URL	Download
----------------------	--	-----	----------

EPLAN Data Portal 285-181		URL	Download
---------------------------	--	-----	----------

Subject to changes. Please also observe the further product documentation!

WAGO GmbH & Co. KG  
 Hansastr. 27  
 32423 Minden  
 Phone: +49571 887-0 | Fax: +49571 887-169  
 Email: [info.de@wago.com](mailto:info.de@wago.com) | Web: [www.wago.com](http://www.wago.com)

Do you have any questions about our products?  
 We are always happy to take your call at +49 (571) 887-44222.

## Environmental Product Compliance

### Compliance Search

Environmental Product Compliance 285-181

URL

Download

2-conductor through terminal block; 95 mm<sup>2</sup>; lateral marker slots; with fixing flanges;  
POWER CAGE CLAMP; 95,00 mm<sup>2</sup>; gray

## Installation Notes

### Installation

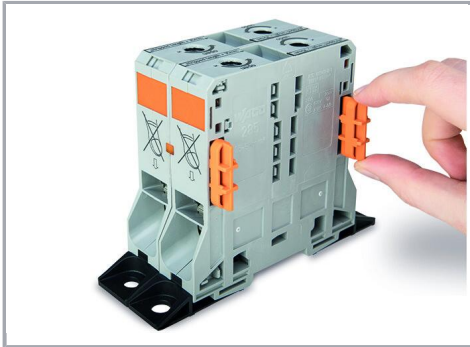

Optionally, insert block-to-block connector (285-168) into housing slot.



Align and snap high-current, through terminal blocks together.

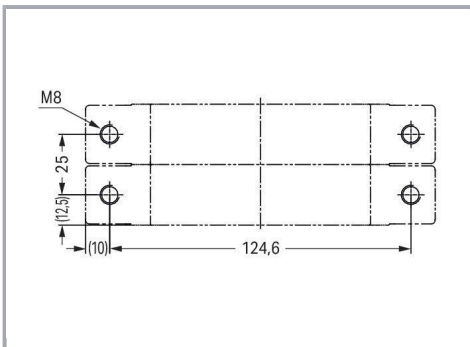

Subject to changes. Please also observe the further product documentation!