

Constant Phase Digital Attenuator 31.0 dB, 5-Bit, TTL Driver, DC-3.0 GHz

Rev. V2

Features

- Attenuation: 1 dB steps to 31 dB
- Minimal Phase Variation over Attenuation Range
- Low DC Power Consumption
- Hermetic Surface Mount Package
- Integral TTL Driver
- 50 Ω Nominal Impedance
- RoHS* Compliant and 260°C Reflow Compatible

Description

The MAAD-009194-000100 is a GaAs FET 5-bit digital attenuator with a 1 dB minimum step size and 31 dB total attenuation. The design has been optimized to minimize phase variation over the attenuation range. This attenuator and integral TTL driver is in a hermetically sealed ceramic 16-lead surface mount package.

The MAAD-009194-000100 is ideally suited for use where accuracy, fast switching, very low power consumption and low intermodulation products are required. Typical applications include dynamic range setting in precision receiver circuits and other gain/leveling control circuits. Environmental screening is available. Contact the factory for information.

Ordering Information ¹

Part Number	Package
MAAD-009194 -000100	Bulk Packaging
MAAD-009194 -0001TB	Sample Test Board

1. Reference Application Note M513 for reel size information.

Functional Schematic

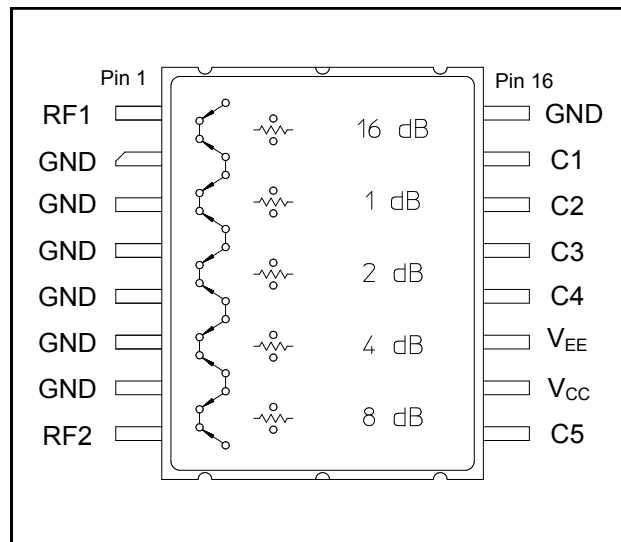

Pin Configuration²

Pin No.	Function	Pin No.	Function
1	RF1	9	C5
2	GND	10	V _{CC}
3	GND	11	V _{EE}
4	GND	12	C4
5	GND	13	C3
6	GND	14	C2
7	GND	15	C1
8	RF2	16	GND

2. The metal bottom of the case must be connected to RF and DC ground.

* Restrictions on Hazardous Substances, European Union Directive 2002/95/EC.

Constant Phase Digital Attenuator 31.0 dB, 5-Bit, TTL Driver, DC-3.0 GHz

Rev. V2

Electrical Specifications: $T_A = 25^\circ\text{C}$, $Z_0 = 50 \Omega$, $V_{CC} = +5.0\text{V}$, $V_{EE} = -5.0\text{V}$

Parameter	Test Conditions	Units	Min.	Typ.	Max.
Operating Power	—	dBm	—	—	+20
Reference Insertion Loss	DC - 1.0 GHz DC - 2.0 GHz DC - 3.0 GHz	dB	—	—	4.5 5.0 5.3
Attenuation Accuracy ³	Any Single Bit, DC - 3.0 GHz Any Combination of Bits, DC - 3.0 GHz	± (0.3 +3% of attenuation setting in dB) dB ± (0.3 +4% of attenuation setting in dB) dB			
Phase Accuracy Relative to Reference Loss State	Any Single Bit, DC - 2.0 GHz Any Single Bit, 2.0 - 3.0 GHz Any Combination of Bits, DC - 1.0 GHz Any Combination of Bits, 1.0 - 2.0 GHz Any Combination of Bits, 2.0 - 3.0 GHz	deg	± 3 ± 5 ± 4 ± 11 ± 18		
VSWR	DC - 3.0 GHz	Ratio	—	—	1.8:1
Trise, Tfall	10% to 90% RF, 90% to 10% RF	ns	See Table 1		
Ton, Toff	1.3 V Control to 90% RF, 1.3 V Control to 10% RF	ns	See Table 1		
1 dB Compression ⁴	Reference State 0.05 GHz 0.5 - 3.0 GHz	dBm	—	>+26 >+26	—
Input IP3	For two-tone Input Power up to +5 dBm 0.05 GHz 0.5 - 3.0 GHz	dBm	—	+39 +41	—
Input IP2	For two-tone Input Power up to +5 dBm 0.05 GHz 0.5 - 3.0 GHz	dBm	—	+45 +68	—
V_{CC} V_{EE}	— —	V	4.5 -8.0	5.0 -5.0	5.5 -4.5
VIL VIH	LOW-level input voltage HIGH-level input voltage	V	0.0 2.0	0.0 5.0	0.8 5.0
I_{IN} (Input Leakage Current)	$V_{IN} = V_{CC}$ or GND	μA	-1	—	1
I_{CC} (Quiescent Supply Current)	$V_{CNTRL} = V_{CC}$ or GND	μA	—	250	400
ΔI_{CC} (Additional Supply Current Per TTL Input Pin)	$V_{CC} = \text{Max}$, $V_{CNTRL} = V_{CC} - 2.1 \text{ V}$	mA	—	—	1.5
I_{EE}	V_{EE} min to max, $V_{IN} = V_{IL}$ or V_{IH}	mA	-1.0	-0.2	—
Thermal Resistance θ_{jc}	—	°C/W	—	50	—

3. This attenuator is guaranteed monotonic.

4. 1 dB Compression was measured up to +26 dBm, which is the absolute maximum rating for this device.

Constant Phase Digital Attenuator 31.0 dB, 5-Bit, TTL Driver, DC-3.0 GHz

Rev. V2

Absolute Maximum Ratings ^{5,6}

Parameter	Absolute Maximum
Max Input Power DC - 3.0 GHz	+26 dBm
V_{CC}	$-0.5V \leq V_{CC} \leq +7.0V$
V_{EE}	$-8.5V \leq V_{EE} \leq +0.5V$
$V_{CC} - V_{EE}$	$-0.5V \leq V_{CC} - V_{EE} \leq 14.5V$
V_{IN}^7	$-0.5V \leq V_{in} \leq V_{CC} + 0.5V$
Operating Temperature	$-55^{\circ}C$ to $+125^{\circ}C$
Storage Temperature	$-65^{\circ}C$ to $+150^{\circ}C$

- Exceeding any one or combination of these limits may cause permanent damage to this device.
- M/A-COM Technology does not recommend sustained operation near these survivability limits.
- Standard CMOS TTL interface, latch-up will occur if logic signal is applied prior to power supply.

Typical Switching Speed (table 1)

Testing Condition	Ton	Trise	Units
Ref. State ↔ 1 dB	3.6	3.6	μs
Ref. State ↔ 2 dB	3.6	3.6	μs
Ref. State ↔ 4 dB	3.7	3.7	μs
Ref. State ↔ 8 dB	3.3	3.3	μs
Ref. State ↔ 16 dB	4.5	4.5	μs
Ref. State ↔ 31 dB	30.5	30.5	μs

Typical Input IP2 and IP3⁸

Attenuation	IP2			IP3			Units
	50 MHz	500 MHz	2 GHz	50 MHz	500 MHz	2 GHz	
Reference State	50	68	70	39	43	42	dBm
1 dB	50	68	70	39	43	37	dBm
2 dB	50	68	70	39	43	37	dBm
4 dB	50	68	70	37	37	37	dBm
8 dB	50	68	70	37	37	37	dBm
16 dB	50	68	65	31	32	32	dBm
31 dB	50	50	50	31	30	29	dBm

- IP2 and IP3 are measured with two-tone inputs F1 and F2 up to +5 dBm with 1 MHz spacing.

Truth Table (Digital Attenuator)

Control Inputs					
C5	C4	C3	C2	C1	Attenuation
0	0	0	0	0	Reference
0	0	0	0	1	16 dB
0	0	0	1	0	1 dB
0	0	1	0	0	2 dB
0	1	0	0	0	4 dB
1	0	0	0	0	8 dB
1	1	1	1	1	31 dB

0 = TTL Low; 1 = TTL High

Recommended PCB Configuration

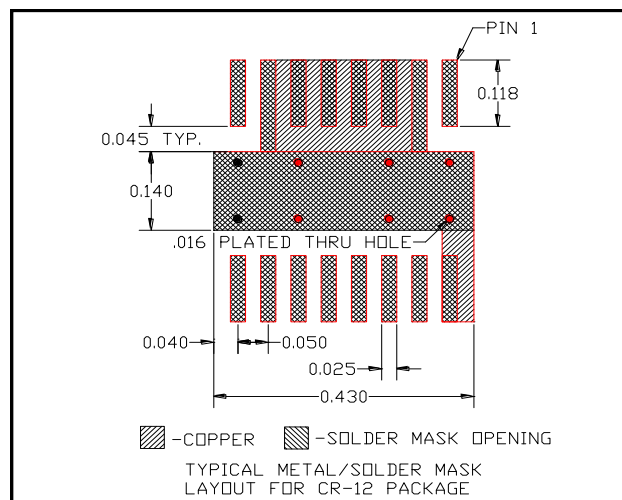

Constant Phase Digital Attenuator 31.0 dB, 5-Bit, TTL Driver, DC-3.0 GHz

Rev. V2

Typical Performance Curves

Reference Loss vs. Frequency

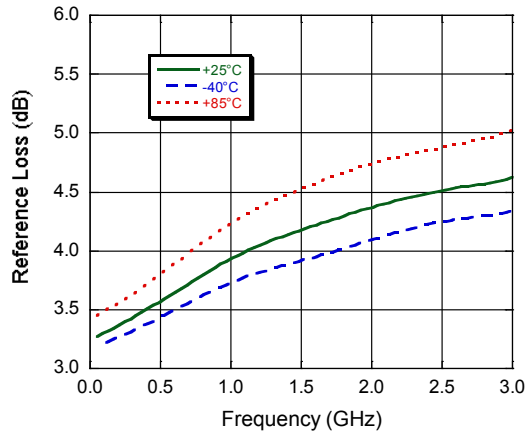

Attenuation - 1 dB Bit vs. Frequency

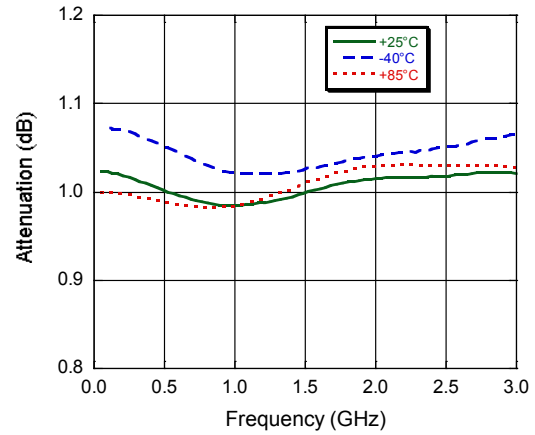

Attenuation - 2 dB Bit vs. Frequency

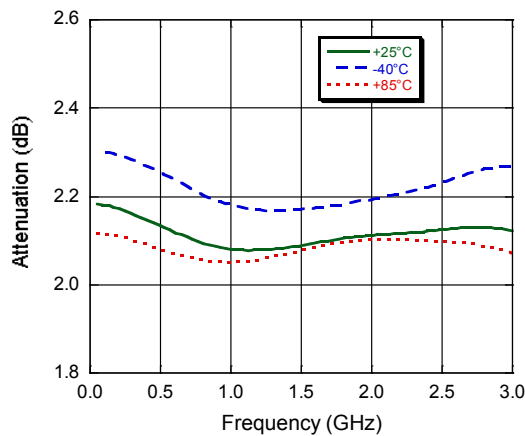

Attenuation - 4 dB Bit vs. Frequency

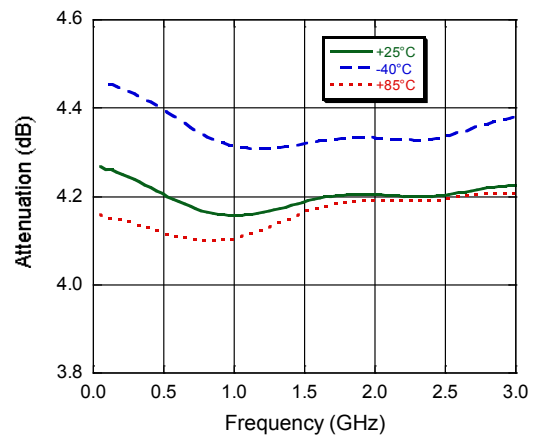

Constant Phase Digital Attenuator 31.0 dB, 5-Bit, TTL Driver, DC-3.0 GHz

Rev. V2

Typical Performance Curves

Attenuation - 8 dB Bit vs. Frequency

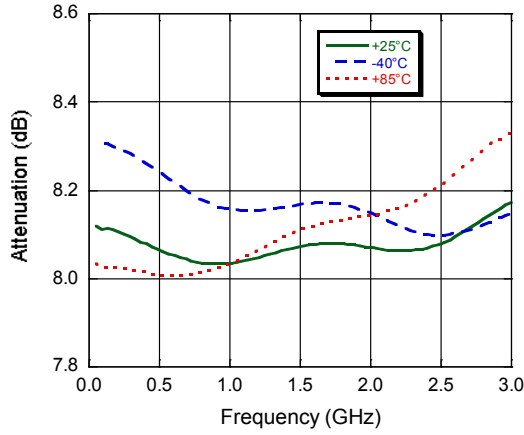

Attenuation - 16 dB Bit vs. Frequency

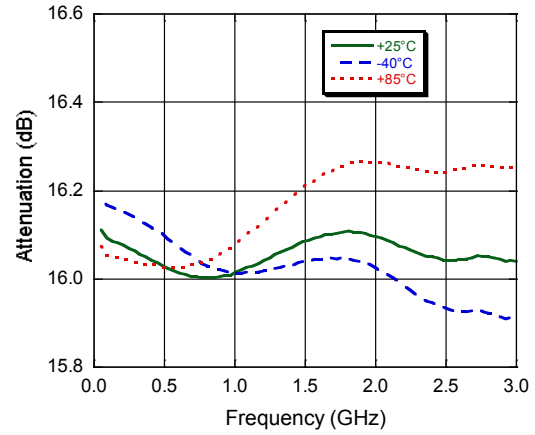

Attenuation - 31 dB Bit vs. Frequency

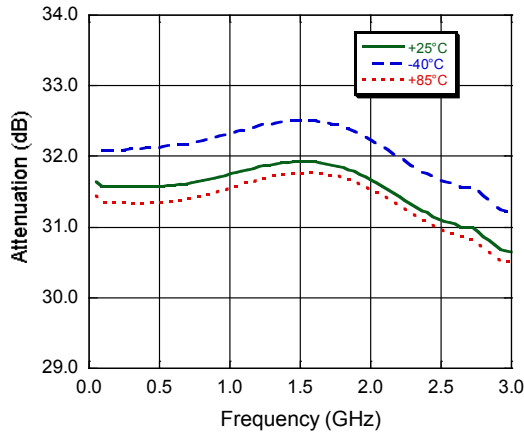

**Phase - 1 dB Bit vs. Frequency
Relative to Reference Loss State**

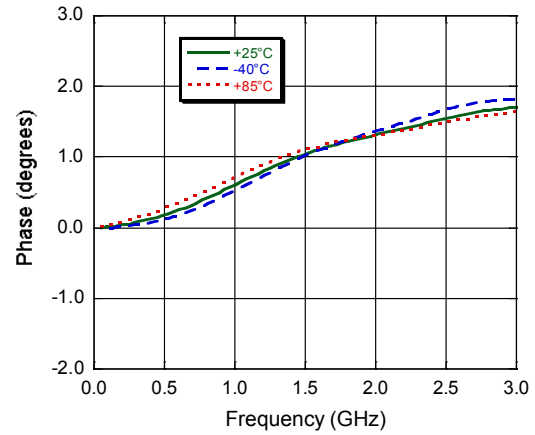

**Phase - 2 dB Bit vs. Frequency
Relative to Reference Loss State**

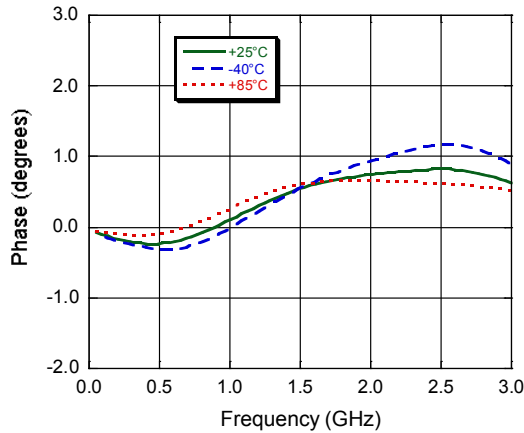

**Phase - 4 dB Bit vs. Frequency
Relative to Reference Loss State**

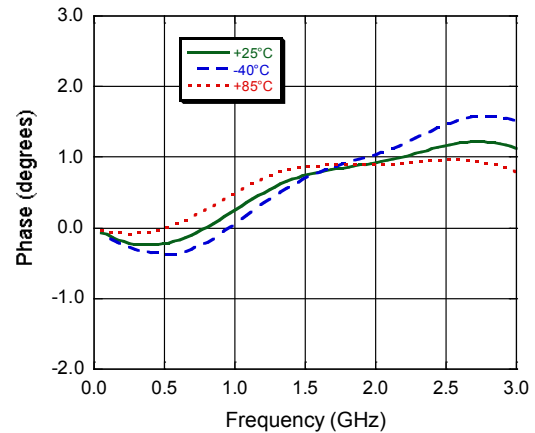

Constant Phase Digital Attenuator 31.0 dB, 5-Bit, TTL Driver, DC-3.0 GHz

Rev. V2

Typical Performance Curves

Phase - 8 dB Bit vs. Frequency
Relative to Reference Loss State

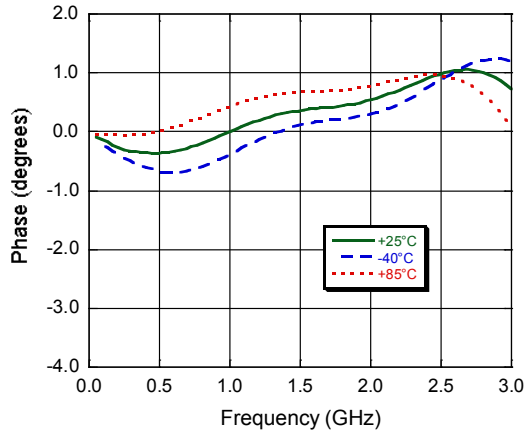

Phase - 16 dB Bit vs. Frequency
Relative to Reference Loss State

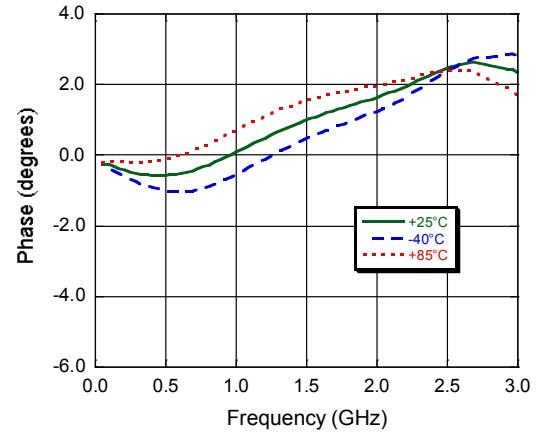

Phase - 31 dB Attenuation vs. Frequency
Relative to Reference Loss State

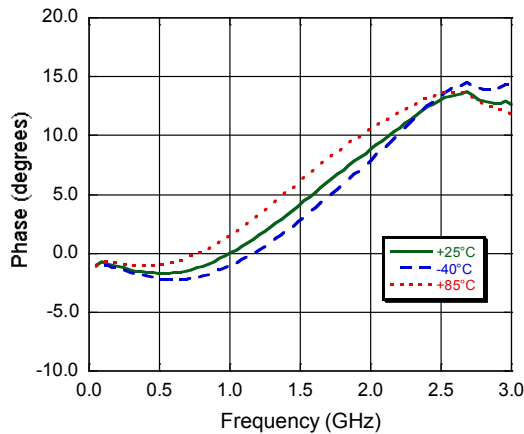

VSWR vs. Frequency
Relative to Reference Loss State

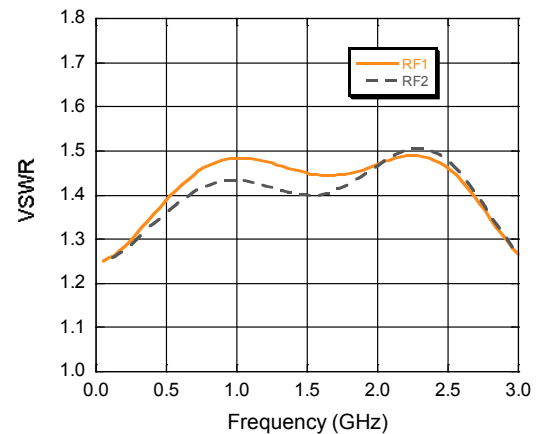

VSWR - 1 dB Bit vs. Frequency

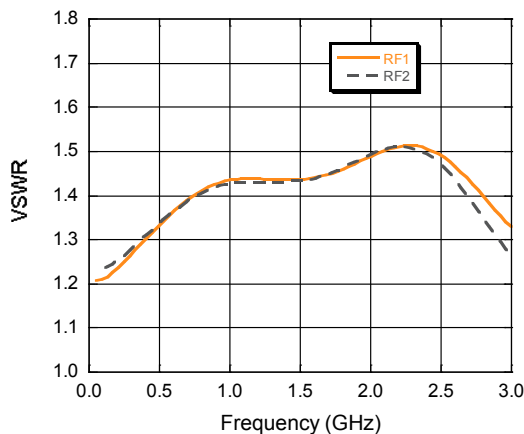

VSWR - 2 dB Bit vs. Frequency

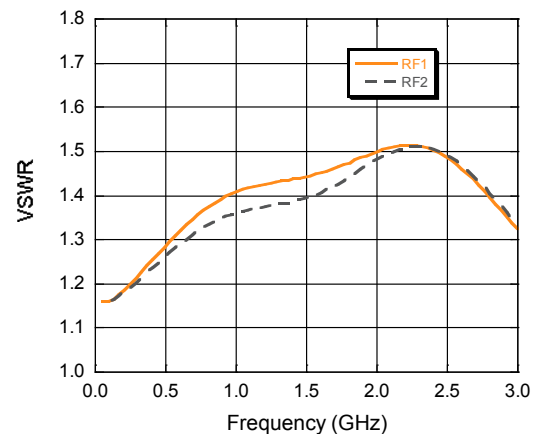

Constant Phase Digital Attenuator 31.0 dB, 5-Bit, TTL Driver, DC-3.0 GHz

Rev. V2

Typical Performance Curves

VSWR - 4 dB Bit vs. Frequency

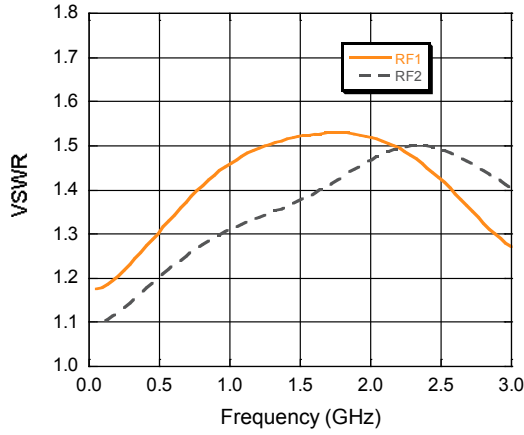

VSWR - 8 dB Bit vs. Frequency

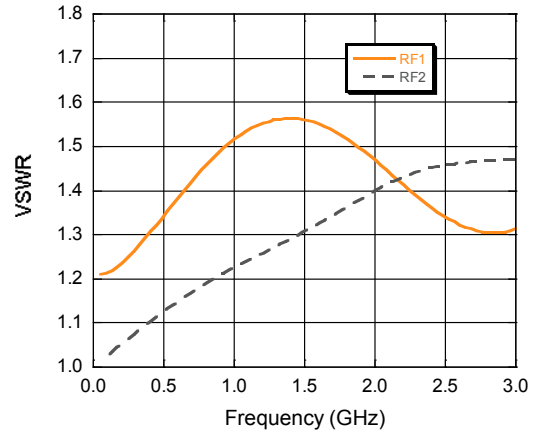

VSWR - 16 dB Bit vs. Frequency

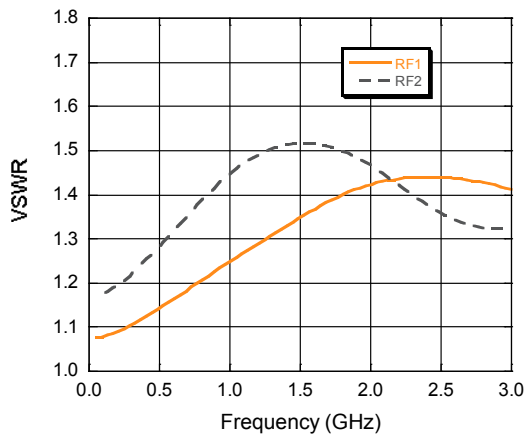

VSWR - 31 dB Attenuation vs. Frequency

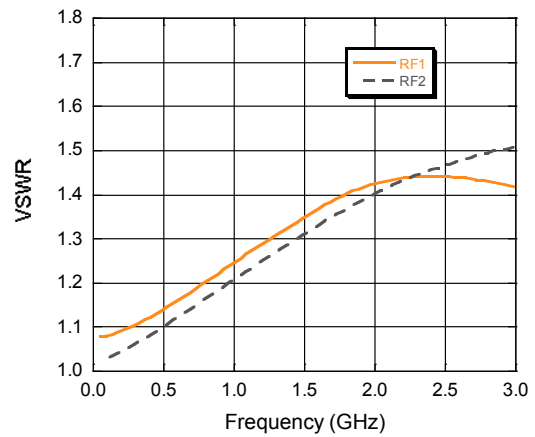

Lead-Free, CR-12 Ceramic Package[†]

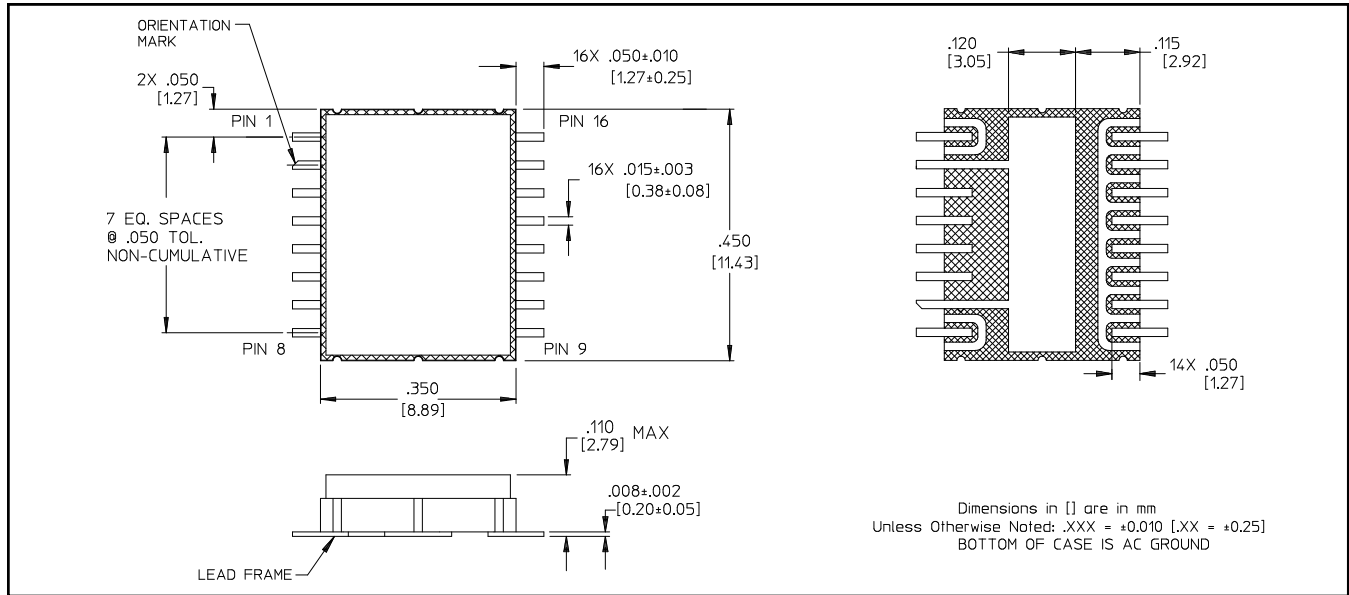

[†] Reference Application Note M538 for lead-free solder reflow recommendations.

Handling Procedures

Please observe the following precautions to avoid damage:

Static Sensitivity

Gallium Arsenide Integrated Circuits are sensitive to electrostatic discharge (ESD) and can be damaged by static electricity. Proper ESD control techniques should be used when handling these devices.

M/A-COM Technology Solutions Inc. All rights reserved.

Information in this document is provided in connection with M/A-COM Technology Solutions Inc ("MACOM") products. These materials are provided by MACOM as a service to its customers and may be used for informational purposes only. Except as provided in MACOM's Terms and Conditions of Sale for such products or in any separate agreement related to this document, MACOM assumes no liability whatsoever. MACOM assumes no responsibility for errors or omissions in these materials. MACOM may make changes to specifications and product descriptions at any time, without notice. MACOM makes no commitment to update the information and shall have no responsibility whatsoever for conflicts or incompatibilities arising from future changes to its specifications and product descriptions. No license, express or implied, by estoppel or otherwise, to any intellectual property rights is granted by this document.

THESE MATERIALS ARE PROVIDED "AS IS" WITHOUT WARRANTY OF ANY KIND, EITHER EXPRESS OR IMPLIED, RELATING TO SALE AND/OR USE OF MACOM PRODUCTS INCLUDING LIABILITY OR WARRANTIES RELATING TO FITNESS FOR A PARTICULAR PURPOSE, CONSEQUENTIAL OR INCIDENTAL DAMAGES, MERCHANTABILITY, OR INFRINGEMENT OF ANY PATENT, COPYRIGHT OR OTHER INTELLECTUAL PROPERTY RIGHT. MACOM FURTHER DOES NOT WARRANT THE ACCURACY OR COMPLETENESS OF THE INFORMATION, TEXT, GRAPHICS OR OTHER ITEMS CONTAINED WITHIN THESE MATERIALS. MACOM SHALL NOT BE LIABLE FOR ANY SPECIAL, INDIRECT, INCIDENTAL, OR CONSEQUENTIAL DAMAGES, INCLUDING WITHOUT LIMITATION, LOST REVENUES OR LOST PROFITS, WHICH MAY RESULT FROM THE USE OF THESE MATERIALS.

MACOM products are not intended for use in medical, lifesaving or life sustaining applications. MACOM customers using or selling MACOM products for use in such applications do so at their own risk and agree to fully indemnify MACOM for any damages resulting from such improper use or sale.

M/A-COM Technology Solutions Inc. (MACOM) and its affiliates reserve the right to make changes to the product(s) or information contained herein without notice.
Visit www.macom.com for additional data sheets and product information.