

CMS07P10V8-HF

P-Channel
RoHS Device
Halogen Free

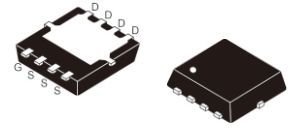

Features

- $V_{DS} = -100V$, $I_D = -7A$, $R_{DS(ON)} = 260m\Omega @ V_{GS} = -10V$.
- Super high density cell design for extremely low $R_{DS(ON)}$.
- High power and current handling capability.

Mechanical data

- Case: PR-PACK(3x3), molded plastic.

Circuit Diagram

- G : Gate
- S : Source
- D : Drain

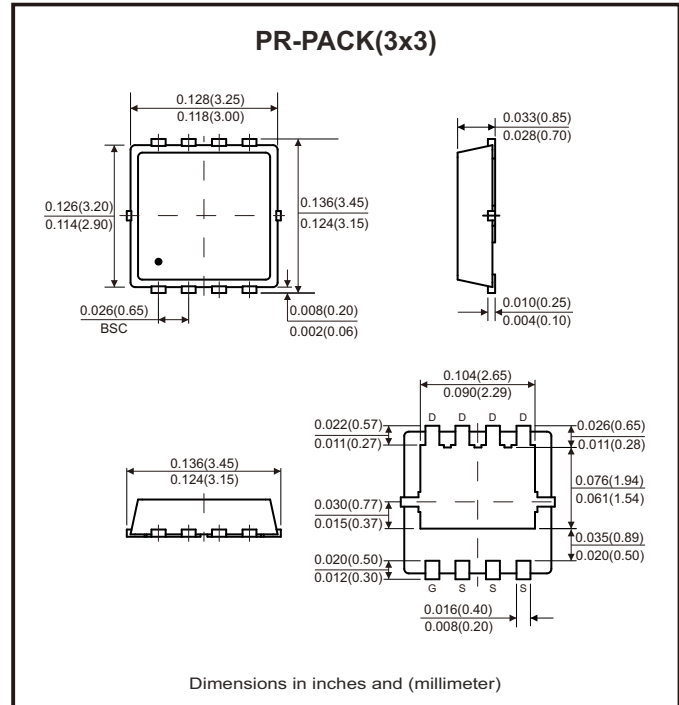
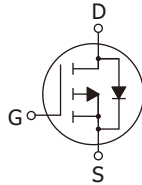

Maximum Ratings (at $T_A = 25^\circ C$ unless otherwise noted)

Parameter	Conditions	Symbol	Value	Unit
Drain-source voltage		V_{DS}	-100	V
Gate-source voltage		V_{GS}	± 20	V
Drain Current-Continuous	$T_C = 25^\circ C$	I_D	-7.0	A
	$T_C = 100^\circ C$		-4.4	
	$T_A = 25^\circ C$		-2.2	
	$T_A = 100^\circ C$		-1.4	
Drain current-pulsed (Note 1)	$T_C = 25^\circ C$	I_{DM}	-28	A
	$T_A = 25^\circ C$		-8.8	
Maximum power dissipation	$T_C = 25^\circ C$	P_D	25	W
	$T_A = 25^\circ C$		2.5	
Operating and storage temperature range		T_J, T_{STG}	-55 to +150	$^\circ C$
Thermal resistance, junction to case (Note 2)		$R_{\theta JC}$	5	$^\circ C/W$
Thermal resistance, junction to ambient (Note 2)		$R_{\theta JA}$	50	$^\circ C/W$

Notes: 1. Repetitive rating: pulse width limited by maximum junction temperature.

2. Surface mounted on FR4 board, $t \leq 10$ sec.

Electrical Characteristics (at $T_c=25^\circ\text{C}$ unless otherwise noted)

Parameter	Symbol	Conditions	Min	Typ	Max	Unit
Off Characteristics						
Drain-source breakdown voltage	BV_{DSS}	$V_{GS} = 0V, I_D = -250\mu A$	-100			V
Zero gate voltage drain current	I_{DSS}	$V_{DS} = -100V, V_{GS} = 0V$			-1	μA
Gate body leakage current, forward	I_{GSSF}	$V_{GS} = 20V, V_{DS} = 0V$			100	nA
Gate body leakage current, reverse	I_{GSSR}	$V_{GS} = -20V, V_{DS} = 0V$			-100	nA
On Characteristics (Note 1)						
Gate threshold voltage	$V_{GS(th)}$	$V_{GS} = V_{DS}, I_D = -250\mu A$	-2		-4	V
Static drain-source on-resistance	$R_{DS(on)}$	$V_{GS} = -10V, I_D = -4A$		210	260	m Ω
Dynamic Characteristics (Note 2)						
Input capacitance	C_{iss}	$V_{DS} = -15V, V_{GS} = 0V, f = 1MHz$		680		pF
Output capacitance	C_{oss}			100		
Reverse transfer capacitance	C_{rss}			60		
Switching Characteristics (Note 2)						
Turn-on delay time	$t_{d(on)}$	$V_{DD} = -80V, I_D = -7A,$ $V_{GS} = -10V, R_{GEN} = 6\Omega$		13		nS
Turn-on rise time	t_r			7		
Turn-off delay time	$t_{d(off)}$			29		
Turn-off fall time	t_f			5		
Total gate charge	Q_g	$V_{DS} = -80V, I_D = -7A, V_{GS} = -10V$		16		nC
Gate-source charge	Q_{gs}			2		
Gate-drain charge	Q_{gd}			6		
Drain-Source-Diode Characteristics and Maximum Ratings						
Drain-source diode forward current	I_S				-7	A
Drain-source diode forward voltage (Note 1)	V_{SD}	$V_{GS} = 0V, I_S = -1A$			-1.2	V

Notes: 1. Pulse test: pulse width $\leq 300\mu s$, duty cycle $\leq 2\%$.

2. Guaranteed by design, not subject to production testing.

Rating and Characteristic Curves (CMS07P10V8-HF)

Fig.1 - Output Characteristics

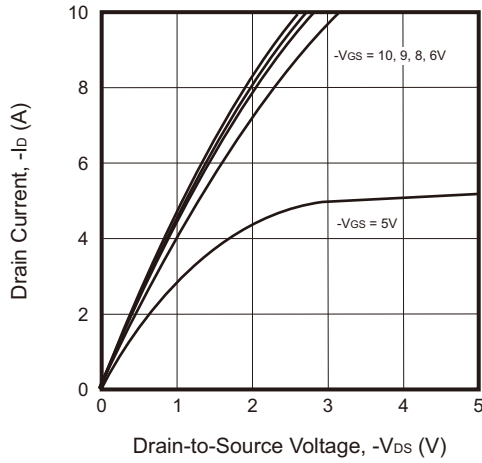

Fig.2 - Transfer Characteristics

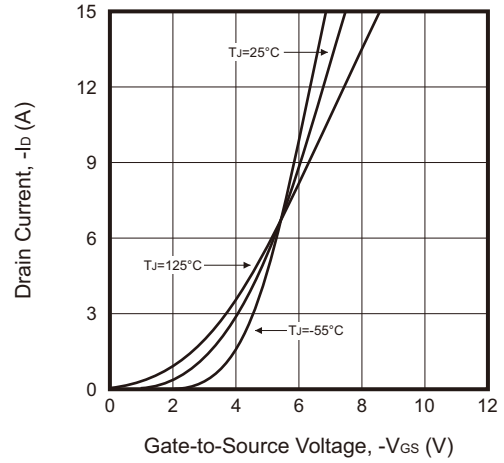

Fig.3 - Capacitance

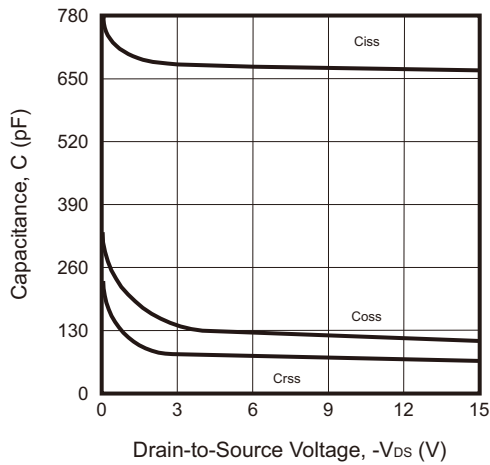

Fig.4 - On-Resistance Variation with Temperature

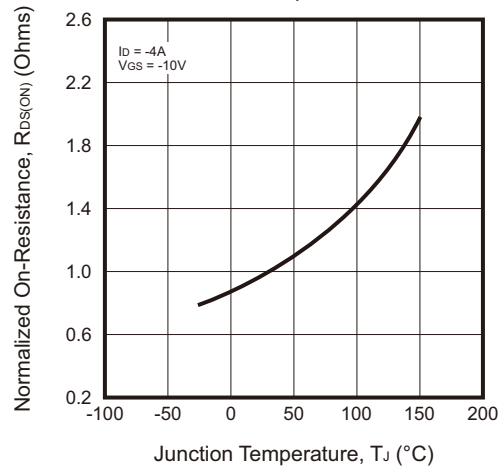

Fig.5 - Gate Threshold Variation with Temperature

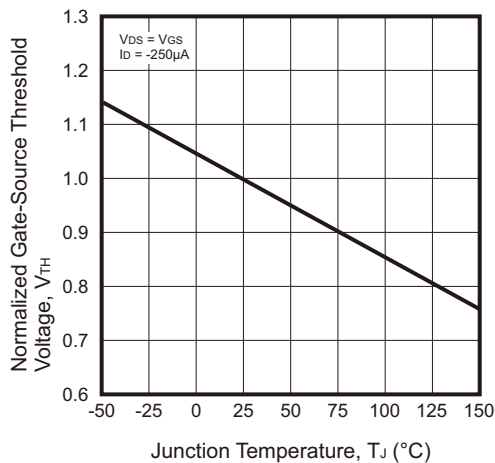
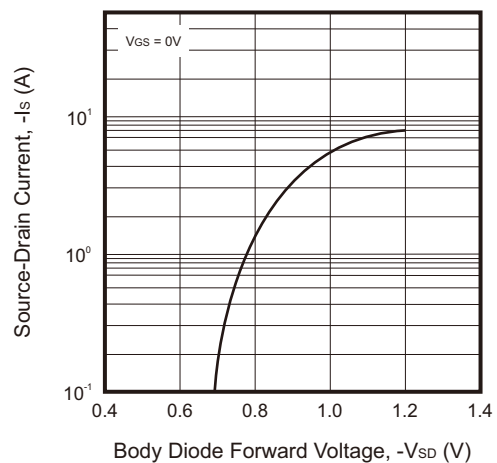

Fig.6 - Body Diode Forward Voltage Variation with Source Current



Rating and Characteristic Curves (CMS07P10V8-HF)

Fig.7 - Gate Charge

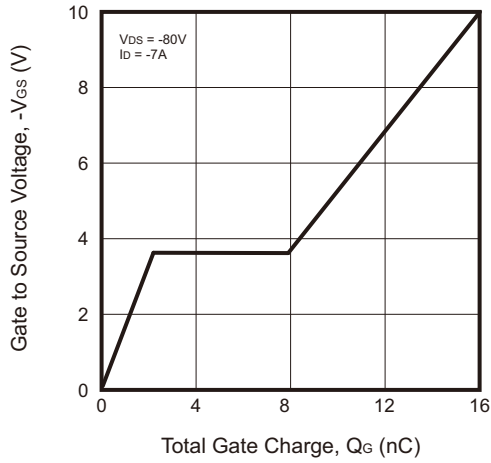

Fig.8 - Maximum Safe Operating Area

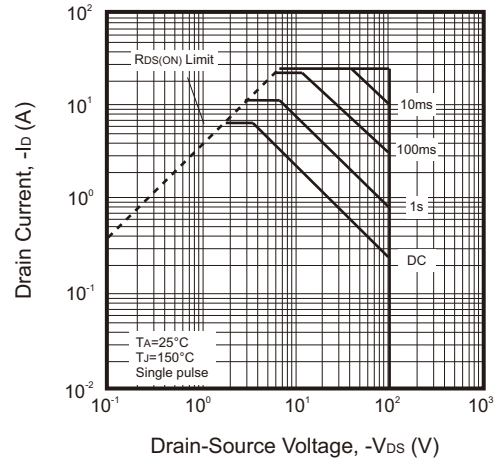
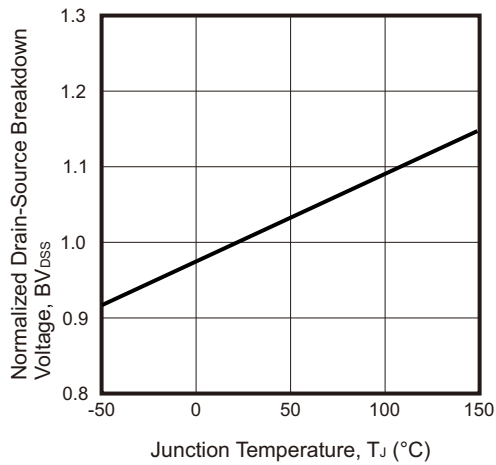
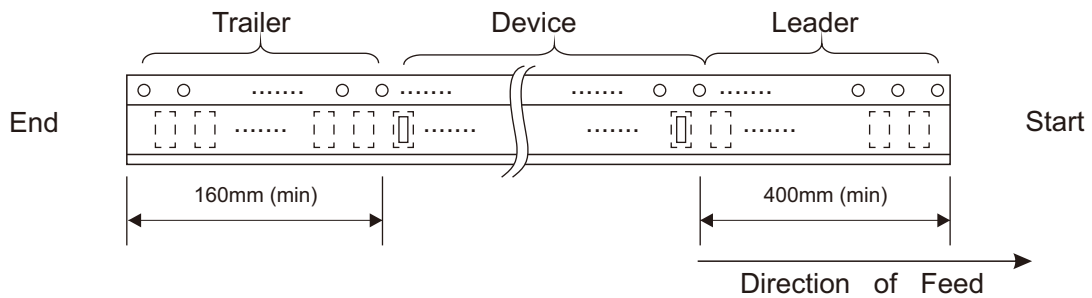
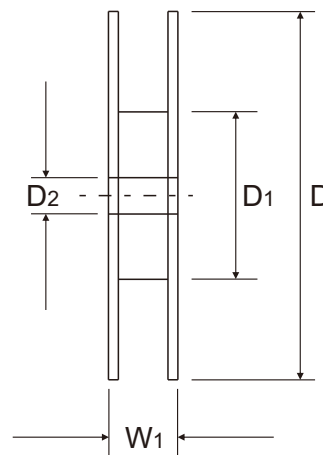
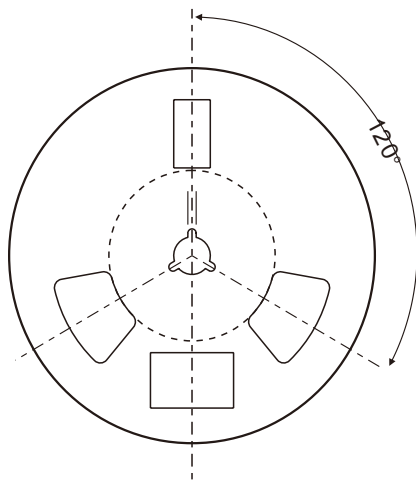
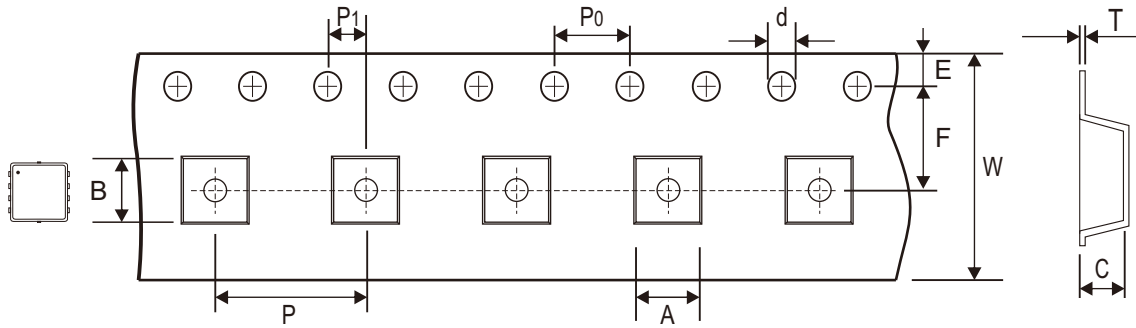

Fig.9 - Breakdown Voltage Variation vs Temperature



Reel Taping Specification



PR-PACK (3x3)	SYMBOL	A	B	C	d	D	D1	D2
	(mm)	3.60 ± 0.10	3.60 ± 0.10	1.20 ± 0.10	1.55 ± 0.05	330.00 ± 2.00	100.00 ± 1.00	13.00 + 0.50 - 0.20
	(inch)	0.142 ± 0.004	0.142 ± 0.004	0.047 ± 0.004	0.061 ± 0.002	12.992 ± 0.079	3.937 ± 0.039	0.512 + 0.020 - 0.008

PR-PACK (3x3)	SYMBOL	E	F	P	P0	P1	T	W	W1
	(mm)	1.75 ± 0.10	5.50 ± 0.10	8.00 ± 0.10	4.00 ± 0.10	2.00 ± 0.10	0.30 ± 0.05	12.00 ± 0.30	16.60 BSC
	(inch)	0.069 ± 0.004	0.217 ± 0.004	0.315 ± 0.004	0.157 ± 0.004	0.079 ± 0.004	0.012 ± 0.002	0.472 ± 0.012	0.654 BSC

Company reserves the right to improve product design , functions and reliability without notice. REV:A

Marking Code

Part Number	Marking Code
CMS07P10V8-HF	1100P XXXXX

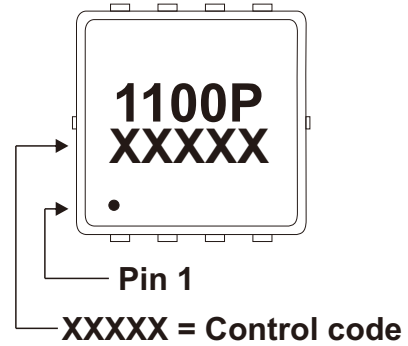

Suggested PAD Layout

SIZE	PR-PACK(3x3)	
	(mm)	(inch)
A	0.30	0.012
B	0.35	0.014
C	0.40	0.016
D	0.42	0.017
E	0.43	0.017
F	0.50	0.020
G	0.65	0.026
H	1.40	0.055
I	1.70	0.067
J	2.28	0.090
K	2.50	0.098
L	3.35	0.132

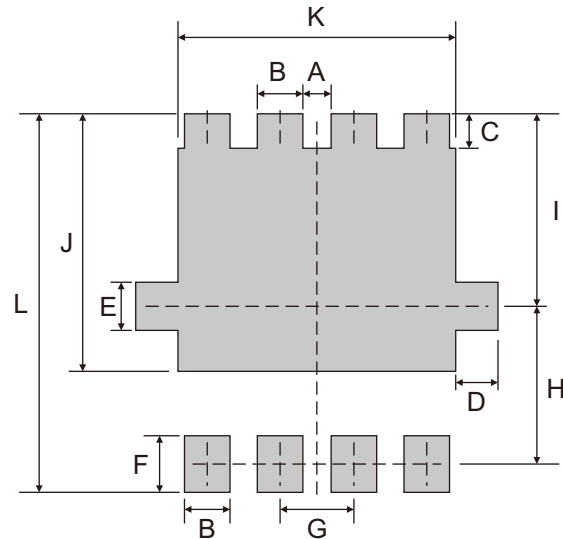

Note: 1. The pad layout is for reference purposes only.

Standard Packaging

Case Type	REEL PACK	
	REEL (pcs)	Reel Size (inch)
PR-PACK(3x3)	5,000	13