

## ANNA-40-7-WW

~65° wide beam with 7 optics

### SPECIFICATION:

Dimensions	Ø 40.0 mm
Height	12.2 mm
Fastening	pin
ROHS compliant	yes ⓘ

### MATERIALS:

Component	Type	Material	Colour	Finish
ANNA-40-7-WW	Multi-lens	PMMA	clear	



### ORDERING INFORMATION:

Component	Qty in box	MOQ	MPQ	Box weight (kg)
C13413_ANNA-40-7-WW » Box size: 480 x 280 x 300 mm	760	120	40	9.0

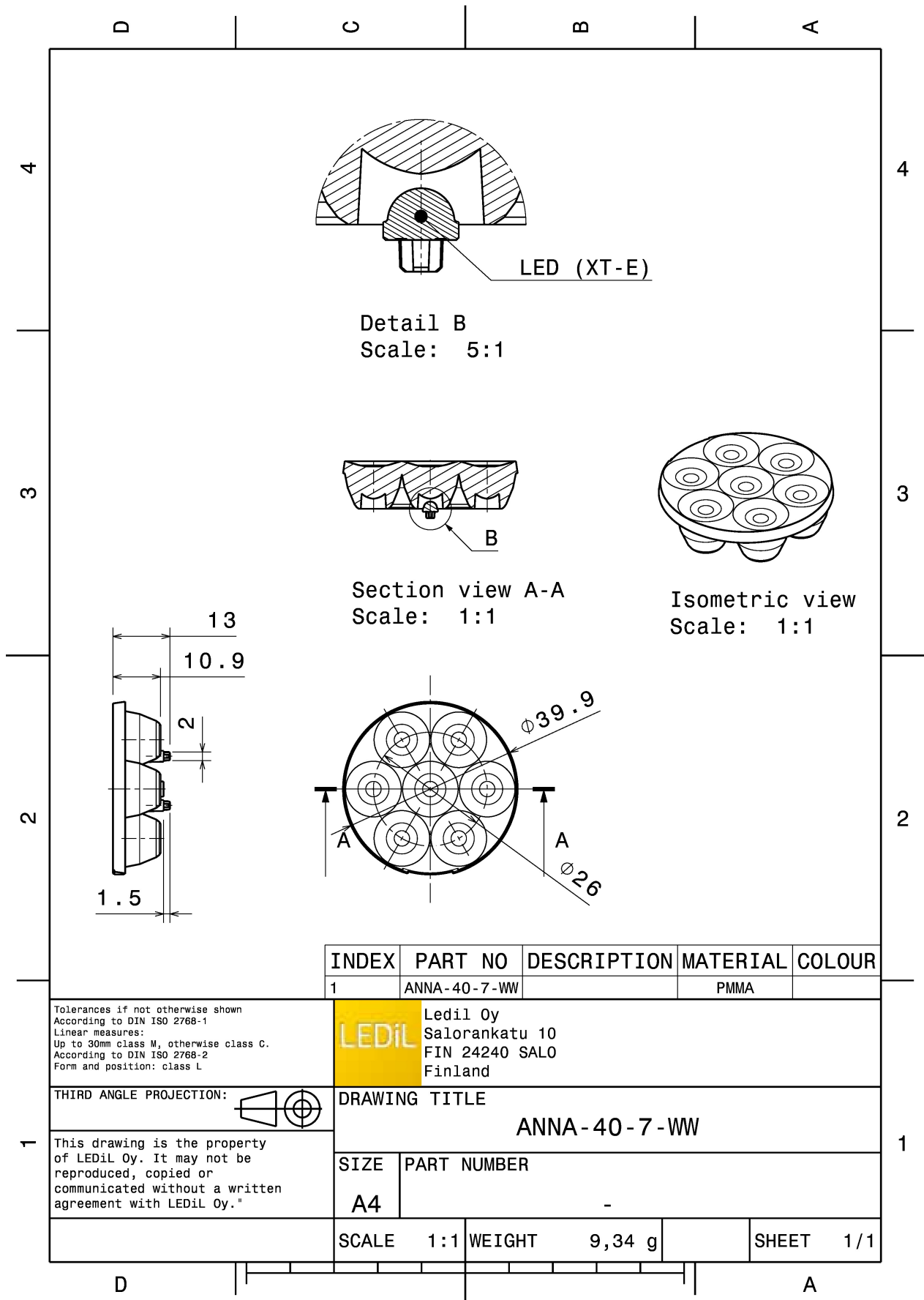

INDEX	PART NO	DESCRIPTION	MATERIAL	COLOUR
1	ANNA-40-7-WW		PMMA	

Tolerances if not otherwise shown  
According to DIN ISO 2768-1  
Linear measures:  
Up to 30mm class M, otherwise class C.  
According to DIN ISO 2768-2  
Form and position: class L

**LEDiL** Ledil Oy  
Salorankatu 10  
FIN 24240 SALO  
Finland

THIRD ANGLE PROJECTION:

DRAWING TITLE  
**ANNA-40-7-WW**

This drawing is the property of LEDiL Oy. It may not be reproduced, copied or communicated without a written agreement with LEDiL Oy."

SIZE	PART NUMBER
A4	-

SCALE	1:1	WEIGHT	9,34 g	SHEET	1/1
-------	-----	--------	--------	-------	-----

See also our general installation guide: [www.ledil.com/installation\\_guide](http://www.ledil.com/installation_guide)

#### OPTICAL RESULTS (SIMULATED):

##### CREE LED

LED J Series 2835  
 FWHM / FWTM 66.0° / 84.0°  
 Efficiency 96 %  
 Peak intensity 1 cd/lm  
 LEDs/each optic 1  
 Light colour White  
 Required components:

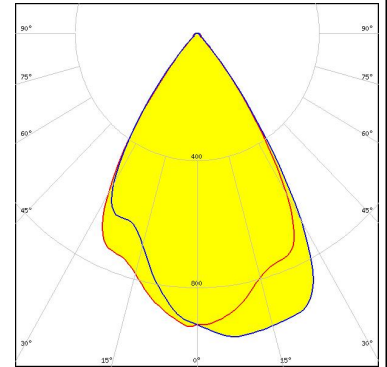

##### CREE LED

LED XB-D  
 FWHM / FWTM 69.0° / 90.0°  
 Efficiency 92 %  
 Peak intensity 0.8 cd/lm  
 LEDs/each optic 1  
 Light colour White  
 Required components:

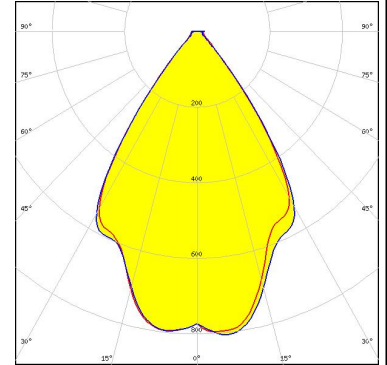

##### CREE LED

LED XP-G3  
 FWHM / FWTM 74.0° / 96.0°  
 Efficiency 92 %  
 Peak intensity 0.7 cd/lm  
 LEDs/each optic 1  
 Light colour White  
 Required components:

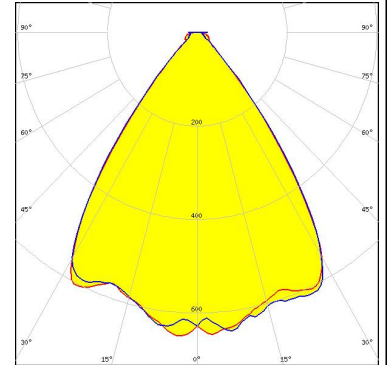

##### CREE LED

LED XT-E  
 FWHM / FWTM 67.0° / 82.0°  
 Efficiency 84 %  
 Peak intensity 0.8 cd/lm  
 LEDs/each optic 1  
 Light colour White  
 Required components:

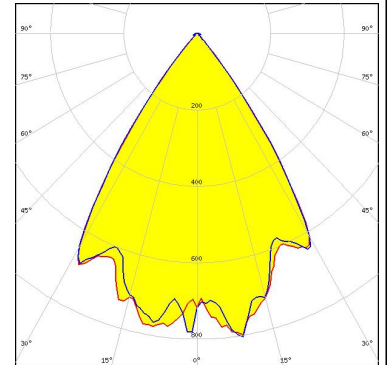

#### OPTICAL RESULTS (SIMULATED):

##### LUMILEDS

LED LUXEON A  
 FWHM / FWTM 69.0° / 84.0°  
 Efficiency 86 %  
 Peak intensity 0.8 cd/lm  
 LEDs/each optic 1  
 Light colour White  
 Required components:

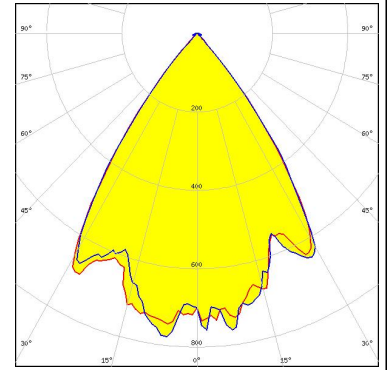

##### LUMILEDS

LED LUXEON R  
 FWHM / FWTM 68.0° / 83.0°  
 Efficiency 88 %  
 Peak intensity 0.8 cd/lm  
 LEDs/each optic 1  
 Light colour White  
 Required components:

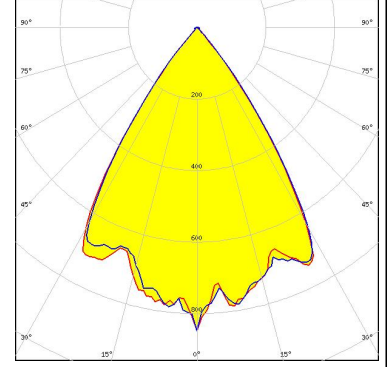

##### LUMILEDS

LED LUXEON Rebel ES  
 FWHM / FWTM 68.0° / 82.0°  
 Efficiency 89 %  
 Peak intensity 0.9 cd/lm  
 LEDs/each optic 1  
 Light colour White  
 Required components:

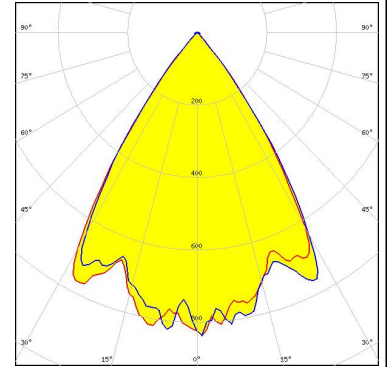

##### LUMILEDS

LED LUXEON T  
 FWHM / FWTM 69.0° / 83.0°  
 Efficiency 88 %  
 Peak intensity 0.8 cd/lm  
 LEDs/each optic 1  
 Light colour White  
 Required components:

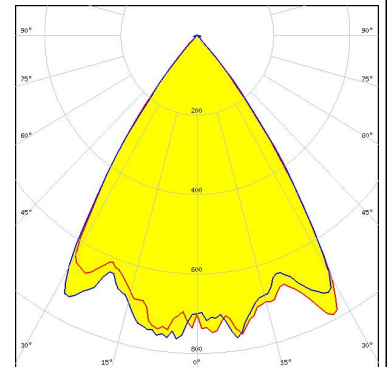

#### OPTICAL RESULTS (SIMULATED):

<p><b>LUMILEDS</b></p> <p>LED: LUXEON TX            FWHM / FWTM: 65.0° / 91.0°            Efficiency: 91 %            Peak intensity: 0.9 cd/lm            LEDs/each optic: 1            Light colour: White            Required components:</p>	
<p><b>NICHIA</b></p> <p>LED: NCSxx19A            FWHM / FWTM: 59.0° / 74.0°            Efficiency: 88 %            Peak intensity: 1.3 cd/lm            LEDs/each optic: 1            Light colour: White            Required components:</p>	
<p><b>NICHIA</b></p> <p>LED: NS9x153            FWHM / FWTM: 64.0° / 82.0°            Efficiency: 85 %            Peak intensity: 0.7 cd/lm            LEDs/each optic: 1            Light colour: White            Required components:</p>	
<p><b>NICHIA</b></p> <p>LED: NS9x383            FWHM / FWTM: 58.0° / 80.0°            Efficiency: 88 %            Peak intensity: 1 cd/lm            LEDs/each optic: 1            Light colour: White            Required components:</p>	

#### OPTICAL RESULTS (SIMULATED):

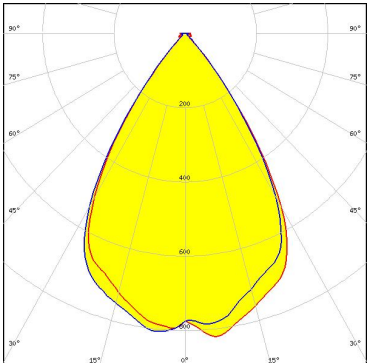
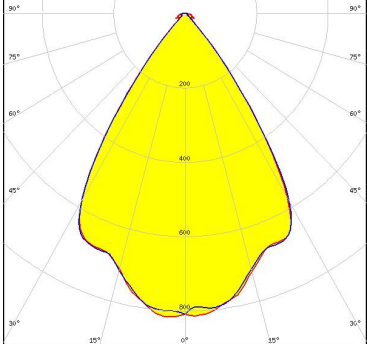
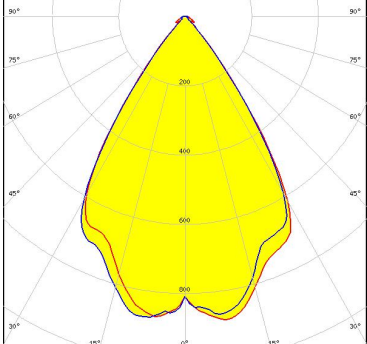
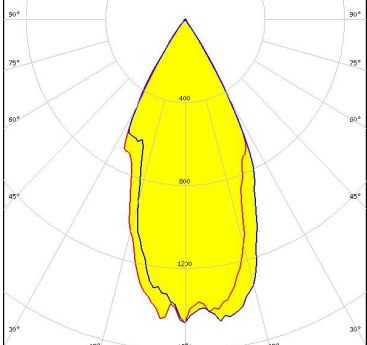
<p><b>NICHIA</b></p> <p>LED: NVSxx19B/NVSxx19C            FWHM / FWTM: 66.0° / 85.0°            Efficiency: 88 %            Peak intensity: 0.8 cd/lm            LEDs/each optic: 1            Light colour: White            Required components:</p>	
<p><b>OSRAM</b> Opto Semiconductors</p> <p>LED: OSOLON Square CSSRM2/CSSRM3            FWHM / FWTM: 68.0° / 86.0°            Efficiency: 91 %            Peak intensity: 0.8 cd/lm            LEDs/each optic: 1            Light colour: White            Required components:</p>	
<p><b>OSRAM</b> Opto Semiconductors</p> <p>LED: SFH 4726S            FWHM / FWTM: 68.0° / 84.0°            Efficiency: 93 %            Peak intensity: 0.9 cd/lm            LEDs/each optic: 1            Light colour: Red            Required components:</p>	
<p><b>SAMSUNG</b></p> <p>LED: LH351A            FWHM / FWTM: 45.0° / 69.0°            Efficiency: 88 %            Peak intensity: 1.5 cd/lm            LEDs/each optic: 1            Light colour: White            Required components:</p>	

**OPTICAL RESULTS (SIMULATED):**

## SAMSUNG

LED LH351B  
 FWHM / FWTM 70.0° / 88.0°  
 Efficiency 91 %  
 Peak intensity 0.8 cd/lm  
 LEDs/each optic 1  
 Light colour White  
 Required components:

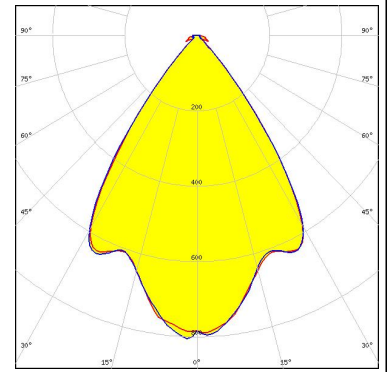

SEOUL SEMICONDUCTOR

LED Z8Y22  
 FWHM / FWTM 56.0° / 76.0°  
 Efficiency 94 %  
 Peak intensity 1.2 cd/lm  
 LEDs/each optic 1  
 Light colour White  
 Required components:

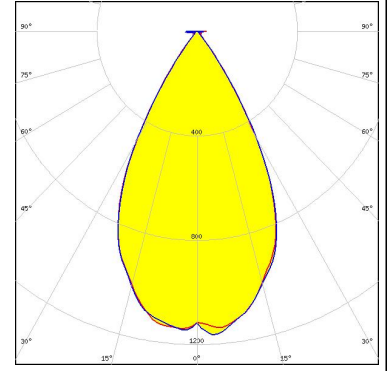

### GENERAL INFORMATION:

NOTE: The typical beam angle will be changed by different color, chip size and chip position tolerance. The typical total beam angle is the full angle measured where the luminous intensity is half of the peak value.

### MATERIALS:

As part of our continuous research and improvement processes, and to ensure the best possible quality and availability of our products, LEDiL reserves the right to change material grades without notice.

### PRODUCT DATA USER AGREEMENT AND DISCLAIMER:

The measured data in the provided downloadable LEDiL Product Datasheets and Mechanical 2D-Drawings is rounded and provided as reference for planning. LEDiL Oy's optical specifications have been verified by conducting performance testing of the products in accordance with the company's quality system. The reported data are averaged results of multiple measurements with typical variation. LEDiL Oy reserves the right to without prior notification make changes and improvements to its products.

LEDiL Oy assumes neither warranty, nor guarantee nor any other liability of any kind for the contents and correctness of the provided data. The provided data has been generated with highest diligence but the provided data may in reality not represent the complete possible variation range of all intrinsic parameters. Therefore, in certain cases a deviation from the provided data could occur.

LEDiL Oy reserves the right to undertake technical changes of its products without further notification which could lead to changes in the provided data. LEDiL Oy assumes no liability of any kind for the possible deviation from any provided data or any other damage resulting from the usage of the provided data.

The user agrees to this disclaimer and user agreement with the download or usage of the provided files.

#### LEDiL Oy

Joensuunkatu 13  
FI-24240 SALO  
Finland

#### LEDiL Inc.

228 West Page Street  
Suite D  
Sycamore IL 60178  
USA

#### Ledil Optics Technology (Shenzhen) Co., Ltd.

# 405 , Block B  
Casic Motor Building  
Shenzhen 518057  
P.R.CHINA

#### Local sales and technical support

[www.ledil.com/  
where\\_to\\_buy](http://www.ledil.com/where_to_buy)

#### Shipping locations

Salo, Finland  
Hong Kong, China

#### Distribution Partners

[www.ledil.com/  
where\\_to\\_buy](http://www.ledil.com/where_to_buy)