

SPECIFICATIONS

CUSTOMER	:	PTC
SAMPLE CODE	:	S05D00063-01
MASS PRODUCTION CODE	:	P05D00063-01
SAMPLE VERSION	:	01
SPECIFICATIONS EDITION	:	001
DRAWING NO. (Ver.)	:	LMD- P05D00063-01 (Ver.001)
PACKAGING NO. (Ver.)	:	PKG- P05D00063-01 (Ver.001)

Customer Approved

Date:

Approved	Checked	Designer
林裘中 Daniel Lin	呂清溪 Marc Lu	陳政佑 Cheney Chen

- Preliminary specification for design input
- Specification for sample approval

POWERTIP TECH. CORP.

Headquarters: No.8, 6 th Road, Taichung Industrial Park, Taichung, Taiwan 台中市 407 工業區六路 8 號	TEL: 886-4-2355-8168 FAX: 886-4-2355-8166	E-mail: sales@powertip.com.tw Http://www.powertip.com.tw
---	--	--

Contents

1. SPECIFICATIONS

- 1.1 Features**
- 1.2 Mechanical Specifications**
- 1.3 Absolute Maximum Ratings**
- 1.4 DC Electrical Characteristics**

2. MODULE STRUCTURE

- 2.1 Counter Drawing**
- 2.2 Interface Pin Description**

3. QUALITY ASSURANCE SYSTEM

- 3.1 Quality Assurance Flow Chart**

4. RELIABILITY TEST

- 4.1 Reliability Test Condition**

5. PRECAUTION RELATING PRODUCT HANDLING

- 5.1 Safety**
- 5.2 Handling**
- 5.3 Storage**
- 5.4 Terms of Warranty**

Appendix : 1. Drawing

2. Packaging Specifications

1. SPECIFICATIONS

1.1 Features

Hardware

CPU	RISC Processor	N32926 (ARM926EJ-S) 64MB DDR2 SDRAM
Memory	On Board Flash *1	1Gb NAND Flash 4GB eMMC (Option)
	External Storage *1	1x Micro SD (max. 32G)
Display	Resolution	Up to 1024 RGB x 768
	Touch Panel *2	Projected Capacitive Touch
	Interface	Parallel RGB 16 bits
I/O	USB	1x USB2.0 Device
	Serial	1 x UART
Power Input	DC	5.0V

Note:

1. Memory type (Option) will be setting by customer's request.
2. Touch Panel Type will be setting by customer's request.
3. Support PWM Signal Output. (5kHz, Duty Cycle: 256 Step)
4. Support JPEG Codec.
5. Support H.264 & MJPEG Codec
6. Support Video Data Processor (VPE)
7. Support RTC

1.2 Mechanical Specifications

Item	Standard Value	Unit
Outline Dimension	77.2(W) x 63.5(L) x 10.6(H) MAX	mm

1.3 Absolute Maximum Ratings

Ta = 25°C

Item	Symbol	Condition	Min.	Max.	Unit
Power Supply	VIN	—	-0.3	6.0	V
Operating Temperature	T _{OP}	—	-20	70	°C
Storage Temperature	T _{ST}	—	-30	80	°C
Humidity	HD	Ta=60 °C	10	90	%RH

1.4 DC Electrical Characteristics

Ta = 25°C

Item	Symbol	Condition	Min.	Typ.	Max.	Unit
Power Supply Voltage	VIN	-	4.8	5.0	5.5	V
Power Supply Current *1	IIN	VIN = 5.0V	-	1.5	2.0	A
Power Consumption of System	PIN	VIN = 5.0V	-	-	10	W
IO High-Level input voltage	V _{IH}	-	2.0	-	V3V3+0.3	V
IO Low-Level input voltage	V _{IL}	-	-	-	0.8	V
IO High-Level output voltage	V _{OH}	-	2.4	-	-	V
IO Low-Level output voltage	V _{OL}	-	-	-	0.4	V

Note 1: Power supply current with Powertip 7" LCM, PH800480T013-IHC

2. MODULE STRUCTURE

2.1 Counter Drawing

2.1.1 Mechanical Diagram

* See Appendix

2.1.2 Block Diagram

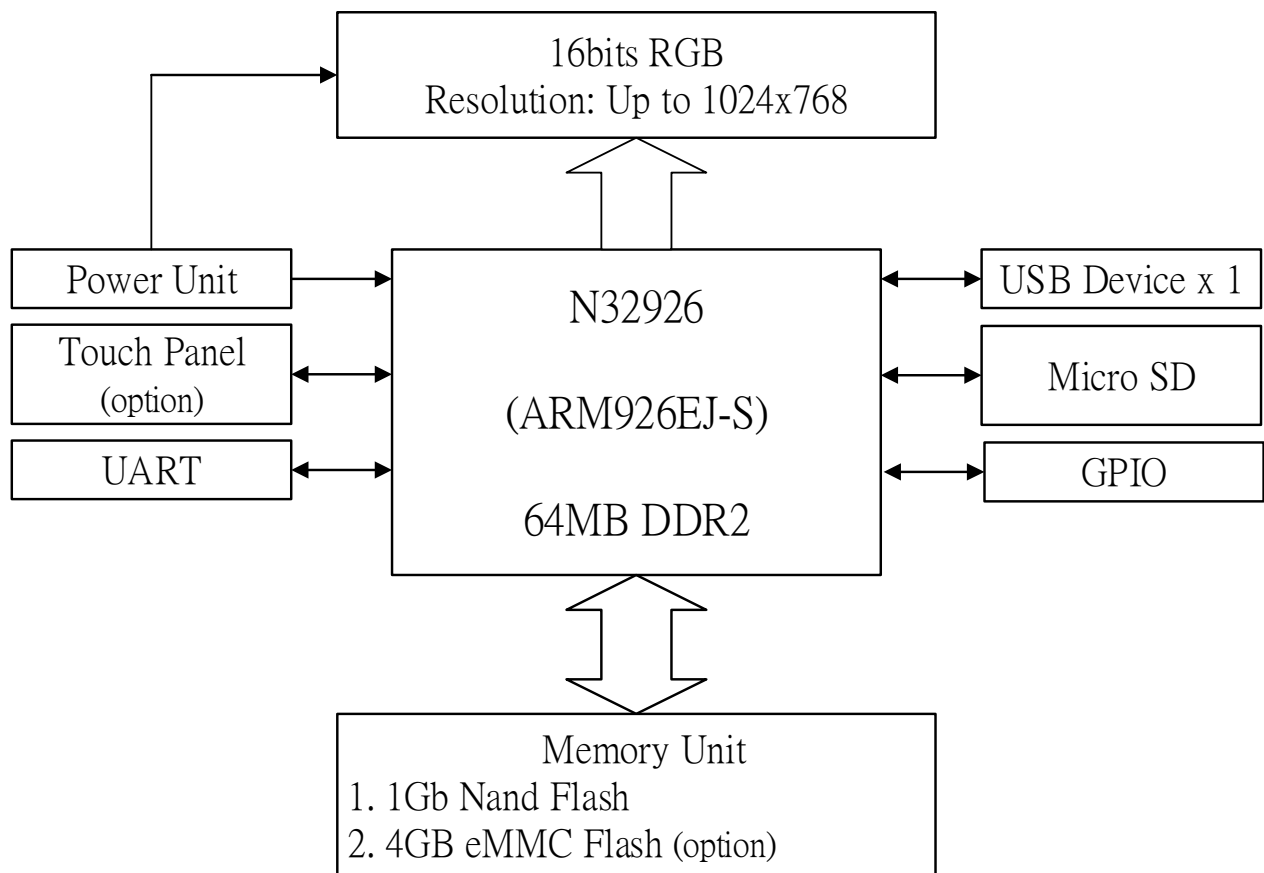

2.2 Interface Pin Description

J8 --- I/O(Pitch0.5mm 6pin Double contact)

Pin No.	Symbol	Type	DESCRIPTION
1	GND	P	Power ground.
2	GPG9	P	General Purpose I/O, Port G[9].
3	NC	-	Not Used.
4	NC	-	Not Used.
5	GND	P	Power ground.
6	GPB13	IO	General Purpose I/O, Port B[13].
7	GND	P	Power ground.
8	GPB14	IO	General Purpose I/O, Port B[14].
9	GND	P	Power ground.
10	GPG2	IO	General Purpose I/O, Port G[2].
11	GND	P	Power ground.
12	GPG4	IO	General Purpose I/O, Port G[4].
13	GPG5	IO	General Purpose I/O, Port G[5].
14	GND	P	Power ground.
15	GPG3	IO	General Purpose I/O, Port G[3].
16	GND	P	Power ground.
17	HPOUT_L	A	Connect to N32926 pin 102.
18	HPOUT_R	A	Connect to N32926 pin 101.
19	GPG7	IO	General Purpose I/O, Port G[7].
20	NC	-	Not Used.
21	GND	P	Power ground.
22	RESETn	I	System reset signal input, active low.
23	UART_RXD	I	UART port, receiver signal.

Pin No.	Symbol	Type	Function
24	UART_TXD	O	UART port, transmitter signal.
25	GND	P	Power ground.
26	VIN	P	DC 5.0V Power Supply.
27	VIN	P	DC 5.0V Power Supply.
28	GPD3	IO	General Purpose I/O, Port D[3].
29	GPD4	IO	General Purpose I/O, Port D[4].
30	GND	P	Power ground.

J9 --- USB 2.0 Device Micro USB type

Pin No.	Symbol	Type	DESCRIPTION
1	VUSB5V	P	USB +5.0V.
2	D-	DS	Data – (Data M).
3	D+	DS	Data + (Data P).
4	NC	-	Not Used.
5	GND	P	Ground.

J7 --- CTP (Pitch0.5mm 6pin Double contact)

Pin No.	Symbol	Type	Function
1	GND	P	Ground.
2	V3V3	P	Power Supply.
3	I2C_SCL	IO	I2C SCL for CTP.
4	I2C_SDA	IO	I2C SDA for CTP.
5	CTP_INT	I	Interrupt Signal for CTP.
6	CTP_RST	O	Reset Signal for CTP.

J2 --- TFT Signal Output (Pitch 0.5mm 50pin Double contact)

Pin No.	Symbol	Type	Function
1	GND	P	Ground.
2	V3V3	P	Power Supply (+3.3V).
3	V3V3	P	Power Supply (+3.3V).
4	V5V	P	Power Supply (+5.0V).
5	V5V	P	Power Supply (+5.0V).
6	PWM	O	PWM Signal.
7	GND	P	Ground.
8	NC	-	Not Used.
9	NC	-	Not Used.
10	NC	-	Not Used.
11	R3	O	Red Data.
12	GND	P	Ground.
13	R4	O	Red Data.
14	R5	O	Red Data.
15	R6	O	Red Data.
16	R7	O	Red Data.
17	GND	P	Ground.
18	NC	-	Not Used.
19	NC	-	Not Used.
20	G2	O	Green Data.
21	G3	O	Green Data.
22	GND	P	Ground.
23	G4	O	Green Data.
24	G5	O	Green Data.
25	G6	O	Green Data.
26	G7	O	Green Data.
27	GND	P	Ground.
28	NC	-	Not Used.
29	NC	-	Not Used.
30	NC	-	Not Used.

Pin No.	Symbol	Type	Function
31	B3	O	Blue Data.
32	GND	P	Ground.
33	B4	O	Blue Data.
34	B5	O	Blue Data.
35	B6	O	Blue Data.
36	B7	O	Blue Data.
37	GND	P	Ground.
38	HS	O	Line synchronization signal. Horizontal Sync.
39	VS	O	Frame synchronization signal. Vertical Sync.
40	GND	P	Ground.
41	DE	O	Data Enable.
42	GND	P	Power Ground.
43	DCLK	O	Sample clock. Data will be latched at the falling edge of DCLK.
44	GND	P	Power ground.
45	SPI_CS1	O	SPI1 /CS1 Signal.
46	SPI1_MOS	O	SPI1 bus, MOSI signal
47	SPI1_CLK	O	SPI1 bus, clock signal
48	DIS_CTL	O	Display Enable Control.
49	/RESET	O	Reset Signal.
50	GND	P	Power ground.

3. QUALITY ASSURANCE SYSTEM

3.1 Quality Assurance Flow Chart

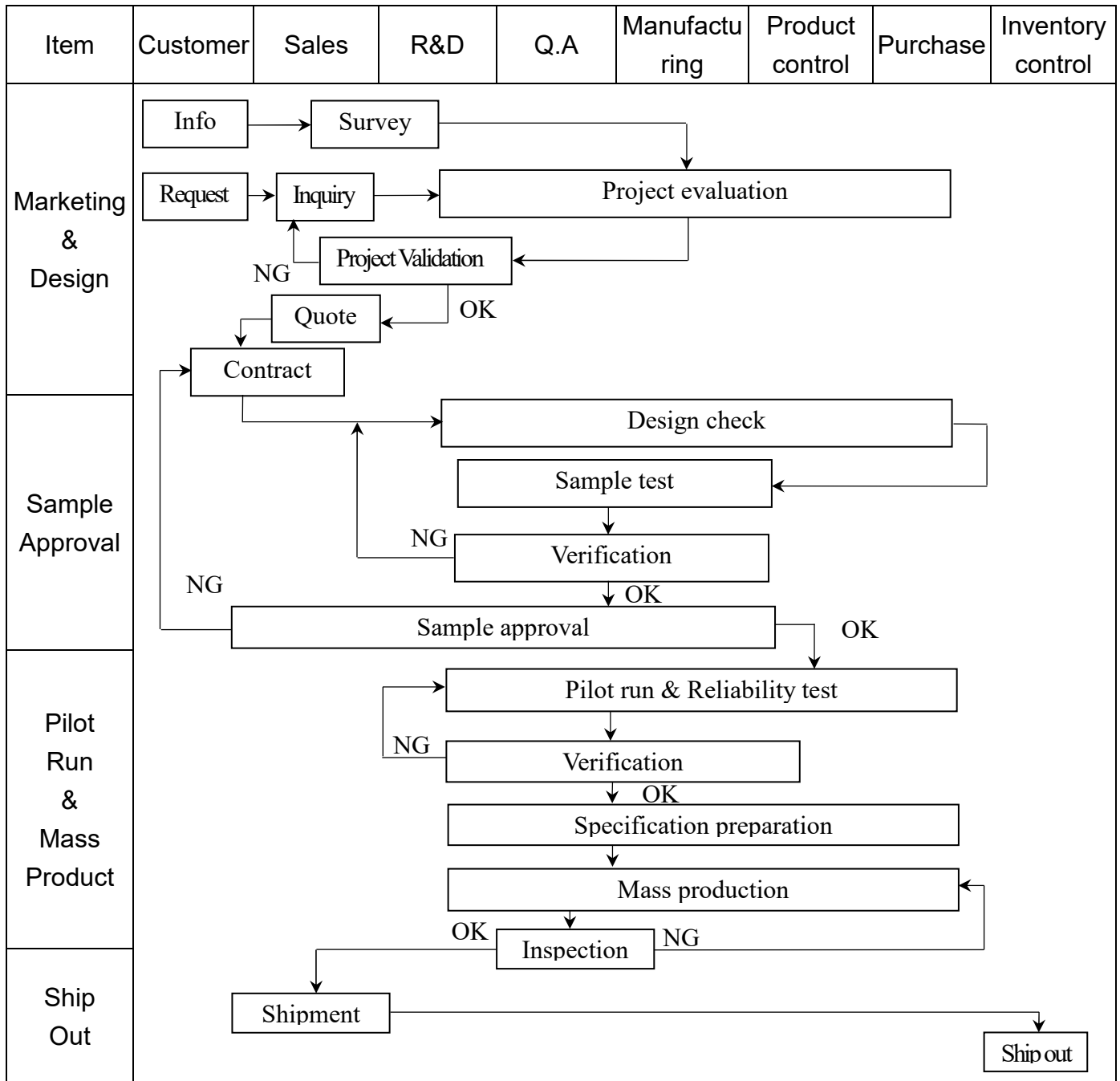

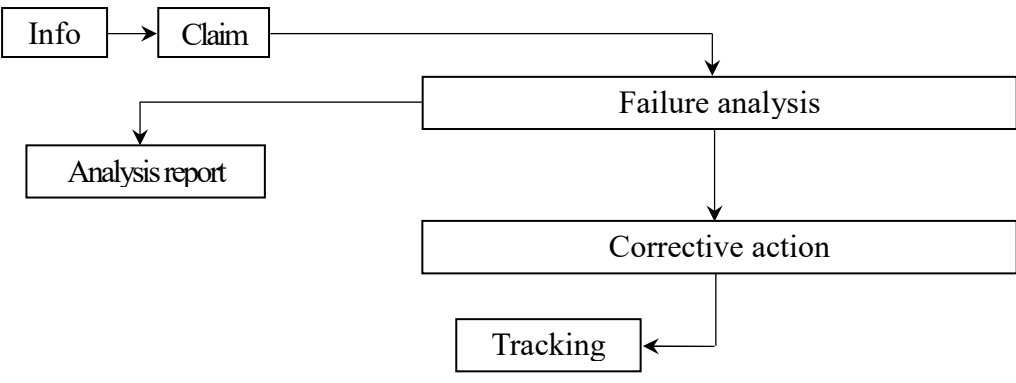
Item	Customer	Sales	R&D	Q.A	Manufacturing	Product control	Purchase	Inventory control
Sales Service	 <pre> graph TD Info[Info] --> Claim[Claim] Claim --> FA[Failure analysis] FA --> AR[Analysis report] FA --> CA[Corrective action] CA --> Tracking[Tracking] </pre>							
Q.A Activity	1. ISO 9001 Maintenance Activities 3. Equipment calibration 5. Standardization Management				2. Process improvement proposal 4. Education And Training Activities			

4. RELIABILITY TEST

4.1 Reliability Test Condition

NO.	TEST ITEM	TEST CONDITION										
1	High Temperature Storage Test	Keep in $+70 \pm 2^{\circ}\text{C}$ 240 hrs Surrounding temperature, then storage at normal condition 4hrs.										
2	Low Temperature Storage Test	Keep in $-20 \pm 2^{\circ}\text{C}$ 240 hrs Surrounding temperature, then storage at normal condition 4hrs.										
3	High Temperature / High Humidity Storage Test	Keep in $+60^{\circ}\text{C}$ / 90% R.H duration for 240 hrs Surrounding temperature, then storage at normal condition 4hrs. (Excluding the polarizer)										
4	Temperature Cycling Storage Test	$-20^{\circ}\text{C} \rightarrow +25^{\circ}\text{C} \rightarrow +70^{\circ}\text{C} \rightarrow +25^{\circ}\text{C}$ (30mins) (5mins) (30mins) (5mins) $\longleftarrow \quad \quad \quad \quad \quad \quad \quad \quad \quad \quad \longrightarrow$ 10 Cycle										
5	Vibration Test (Packaged)	1. Sine wave 10~55 Hz frequency (1 min) 2. The amplitude of vibration :1. 5 mm 3. Each direction (X 、 Y 、 Z) duration for 2 Hrs										
6	Drop Test (Packaged)	<table border="1" style="margin-left: auto; margin-right: auto;"> <thead> <tr> <th style="text-align: center;">Packing Weight (Kg)</th> <th style="text-align: center;">Drop Height (cm)</th> </tr> </thead> <tbody> <tr> <td style="text-align: center;">0 ~ 45.4</td> <td style="text-align: center;">122</td> </tr> <tr> <td style="text-align: center;">45.4 ~ 90.8</td> <td style="text-align: center;">76</td> </tr> <tr> <td style="text-align: center;">90.8 ~ 454</td> <td style="text-align: center;">61</td> </tr> <tr> <td style="text-align: center;">Over 454</td> <td style="text-align: center;">46</td> </tr> </tbody> </table> Drop direction :※1 corner / 3 edges / 6 sides each 1times	Packing Weight (Kg)	Drop Height (cm)	0 ~ 45.4	122	45.4 ~ 90.8	76	90.8 ~ 454	61	Over 454	46
Packing Weight (Kg)	Drop Height (cm)											
0 ~ 45.4	122											
45.4 ~ 90.8	76											
90.8 ~ 454	61											
Over 454	46											

5. PRECAUTION RELATING PRODUCT HANDLING

5.1 SAFETY

- 5.1.1 If the LCD panel breaks, be careful not to get the liquid crystal to touch your skin.
- 5.1.2 If the liquid crystal touches your skin or clothes, please wash it off immediately by using soap and water.

5.2 HANDLING

- 5.2.1 Avoid any strong mechanical shock which can break the glass.
- 5.2.2 Avoid static electricity which can damage the CMOS LSI—When working with the module, be sure to ground your body and any electrical equipment you may be using.
- 5.2.3 Do not remove the panel or frame from the module.
- 5.2.4 The polarizing plate of the display is very fragile. So, please handle it very carefully, do not touch, push or rub the exposed polarizing with anything harder than an HB pencil lead (glass, tweezers, etc.)
- 5.2.5 Do not wipe the polarizing plate with a dry cloth, as it may easily scratch the surface of plate.
- 5.2.6 Do not touch the display area with bare hands, this will stain the display area.
- 5.2.7 Do not use ketonics solvent & aromatic solvent. Use with a soft cloth soaked with a cleaning naphtha solvent.
- 5.2.8 To control temperature and time of soldering is $320\pm 10^{\circ}\text{C}$ and 3-5 sec.
- 5.2.9 To avoid liquid (include organic solvent) stained on LCM.





5.3 STORAGE

- 5.3.1 Store the panel or module in a dark place where the temperature is $25^{\circ}\text{C} \pm 5^{\circ}\text{C}$ and the humidity is below 65% RH.
- 5.3.2 Do not place the module near organics solvents or corrosive gases.
- 5.3.3 Do not crush, shake, or jolt the module.

5.4 TERMS OF WARRANTY

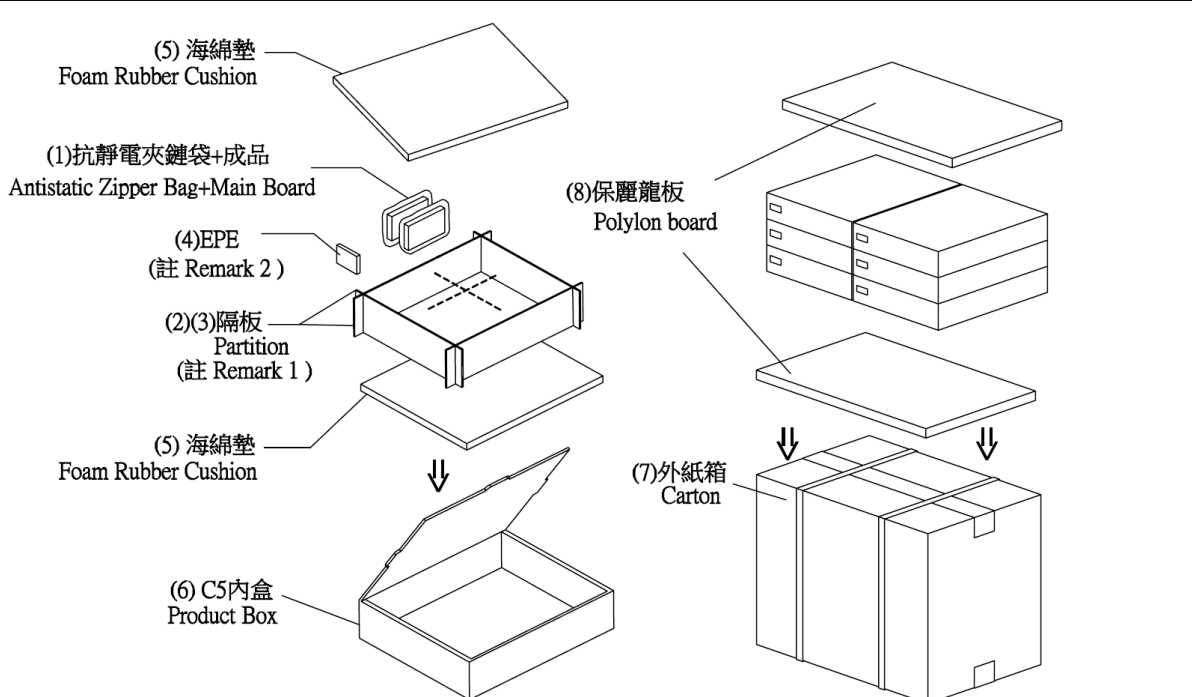
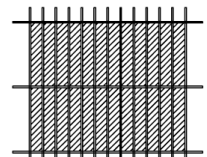
- 5.4.1 Applicable warrant period
The period is within thirteen months since the date of shipping out under normal using and storage conditions.
- 5.4.2 Unaccepted responsibility
This product has been manufactured to your company's specification as a part for use in your company's general electronic products. It is guaranteed to perform according to delivery specifications. For any other use apart from general electronic equipment, we cannot take responsibility if the product is used in nuclear power control equipment, aerospace equipment, fire and security systems or any other applications in which there is a direct risk to human life and where extremely high levels of reliability are required.

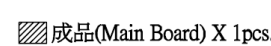
Appendix: 2. Packaging Specifications

Ver.001		包裝規格書 Packaging Specifications		Approve	Check	Contact
Documents NO.	PKG-P05D00063-01			Daniel	Marcus	Nini
1. 包裝材料規格表 (Packaging Material) : (per carton)						
No.	Item	Model	Dimensions (mm)	1Pcs Weight	Quantity	Total Weight
1	成品 (Main Board)	P05D00063-01	77.2X 63.5	0.02	144	2.88
2	靜電夾鏈袋(1)Antistatic Zipper Bag	BAG0000000050	90 X 130	0.002	144	0.288
3	B2隔板(2)B2 Partition	BX24500070BLBA	245 X 70 X 2.5	0.01	78	0.78
4	B4隔板(3)B4 Partition	BX29300070BLBA	293 X 70 X 2.5	0.012	18	0.216
5	舒美布(4)EPE	OTFOAM00112ABA	125 X 85.0 X 15	0.004	12	0.048
6	海綿墊(5)Foam Rubber Cushion	OTFOAM00006ABA	290 X 240 X 10	0.02	12	0.24
7	C3內盒(6)Product Box	BX31025510AABA	310 X 255 X 105	0.162	6	0.972
8	外紙箱(7)Carton	BX52732536CCBA	527 X 325 X 360	0.83	1	0.83
9	保麗龍板(8)Polylon board	OTPLB00000017	510 X 310 X 15	0.025	2	0.05
2. 一整箱總重量 (Total Weight in carton) : 6.3 Kg±10%						
3. 單箱數量規格表 (Packaging Specifications and Quantity) :						
(1)Quantity Of Spacer : B2隔板 X 13 , B4隔板 X 3						
(2)Total Main Board quantity in carton : quantity per box 24 x no of boxes 6 = 144						
						
特 記 事 項 (REMARK)						
1. 成品排布示意圖(前後間隔不放置): 1. Main Board placed as figure showing: (First and last slot should be empty)		2. OTFOAM00112ABA 裁成 尺寸:62.5 X 85 X 15 mm * 2 每盒用2pcs				
						
 成品(Main Board) X 1pcs.		 EPE X 0.5 pcs.				

POWER TIP TECH. CORP.