

## ST-204A3

Aliases (UDLST00204A300)

KEMET, ST, DC Line Filters, Common Mode

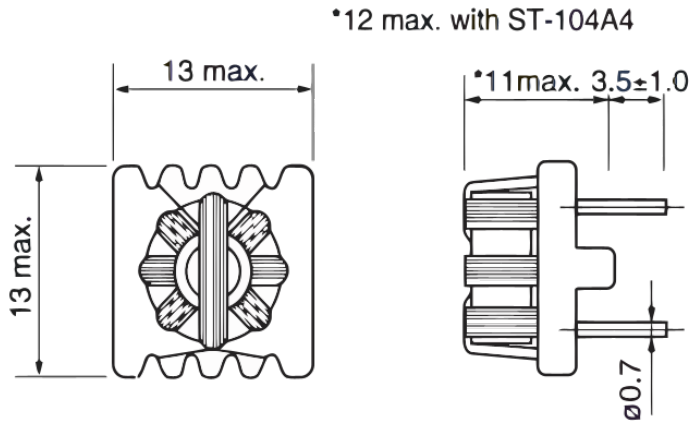

Click [here](#) for the 3D model.

### Dimensions

L	13mm MAX
W	13mm MAX
H	11mm MAX
LL	3.5mm +/-1mm

### Packaging Specifications

Packaging	Tray, Box
Packaging Quantity	4800
Component Weight	2.31 g

### General Information

Series	ST
Style	Through-Hole
RoHS	Yes
Miscellaneous	FM Band, Frequency Range: 7 To 40 MHz, Impedance: 1000 Ohms (7 MHz).

### Specifications

Voltage DC	50 VDC
Temperature Range	-20/+75°C
DC Resistance	170 mOhms