

# Q3-Class HiperFET™ Power MOSFET

## IXFR80N50Q3

(Electrically Isolated Tab)

N-Channel Enhancement Mode  
Fast Intrinsic Rectifier

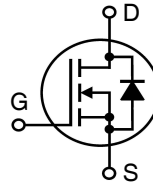

$V_{DSS} = 500V$   
 $I_{D25} = 50A$   
 $R_{DS(on)} \leq 72m\Omega$   
 $t_{rr} \leq 250ns$

ISOPLUS247  
 E153432

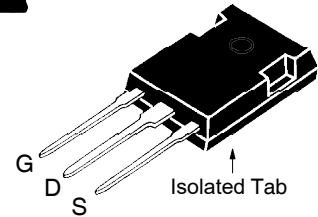

G = Gate    D = Drain  
 S = Source

Symbol	Test Conditions	Maximum Ratings	
$V_{DSS}$	$T_J = 25^\circ C$ to $150^\circ C$	500	V
$V_{DGR}$	$T_J = 25^\circ C$ to $150^\circ C$ , $R_{GS} = 1M\Omega$	500	V
$V_{GSS}$	Continuous	$\pm 30$	V
$V_{GSM}$	Transient	$\pm 40$	V
$I_{D25}$	$T_C = 25^\circ C$	50	A
$I_{DM}$	$T_C = 25^\circ C$ , Pulse Width Limited by $T_{JM}$	240	A
$I_A$	$T_C = 25^\circ C$	80	A
$E_{AS}$	$T_C = 25^\circ C$	5	J
$dv/dt$	$I_S \leq I_{DM}$ , $V_{DD} \leq V_{DSS}$ , $T_J \leq 150^\circ C$	50	V/ns
$P_D$	$T_C = 25^\circ C$	570	W
$T_J$		-55 ... +150	$^\circ C$
$T_{JM}$		150	$^\circ C$
$T_{stg}$		-55 ... +150	$^\circ C$
$T_L$	Maximum Lead Temperature for Soldering	300	$^\circ C$
$T_{SOLD}$	1.6 mm (0.062in.) from Case for 10s	260	$^\circ C$
$V_{ISOL}$	50/60 Hz, 1 Minute	2500	V~
$F_C$	Mounting Force	20..120/4.5..27	N/lb.
<b>Weight</b>		5	g

### Features

- Silicon Chip on Direct-Copper Bond (DCB) Substrate
- Isolated Mounting Surface
- Low Intrinsic Gate Resistance
- 2500V~ Electrical Isolation
- Fast Intrinsic Rectifier
- Avalanche Rated
- Low Package Inductance

### Advantages

- High Power Density
- Easy to Mount
- Space Savings

### Applications

- DC-DC Converters
- Battery Chargers
- Switch-Mode and Resonant-Mode Power Supplies
- DC Choppers
- Temperature and Lighting Controls

Symbol	Test Conditions ( $T_J = 25^\circ C$ Unless Otherwise Specified)	Characteristic Values		
		Min.	Typ.	Max.
$BV_{DSS}$	$V_{GS} = 0V$ , $I_D = 3mA$	500		V
$V_{GS(th)}$	$V_{DS} = V_{GS}$ , $I_D = 8mA$	3.5		6.5 V
$I_{GSS}$	$V_{GS} = \pm 30V$ , $V_{DS} = 0V$			$\pm 200$ nA
$I_{DSS}$	$V_{DS} = V_{DSS}$ , $V_{GS} = 0V$ $T_J = 125^\circ C$			50 $\mu A$ 2 mA
$R_{DS(on)}$	$V_{GS} = 10V$ , $I_D = 40A$ , Note 1			72 m $\Omega$

Symbol	Test Conditions ( $T_J = 25^\circ\text{C}$ Unless Otherwise Specified)	Characteristic Values		
		Min.	Typ.	Max.
$g_{fs}$	$V_{DS} = 20\text{V}, I_D = 40\text{A}$ , Note 1	35	55	S
$C_{iss}$	$V_{GS} = 0\text{V}, V_{DS} = 25\text{V}, f = 1\text{MHz}$		10	nF
$C_{oss}$			1260	pF
$C_{rss}$			115	pF
$R_{Gi}$	Gate Input Resistance		0.15	$\Omega$
$t_{d(on)}$	<b>Resistive Switching Times</b> $V_{GS} = 10\text{V}, V_{DS} = 0.5 \cdot V_{DSS}, I_D = 40\text{A}$ $R_G = 1\Omega$ (External)		30	ns
$t_r$			20	ns
$t_{d(off)}$			43	ns
$t_f$			15	ns
$Q_{g(on)}$	$V_{GS} = 10\text{V}, V_{DS} = 0.5 \cdot V_{DSS}, I_D = 40\text{A}$		200	nC
$Q_{gs}$			77	nC
$Q_{gd}$			90	nC
$R_{thJC}$				0.22 $^\circ\text{C/W}$
$R_{thCS}$		0.15		$^\circ\text{C/W}$

**Source-Drain Diode**

Symbol	Test Conditions ( $T_J = 25^\circ\text{C}$ Unless Otherwise Specified)	Characteristic Values		
		Min.	Typ.	Max.
$I_S$	$V_{GS} = 0\text{V}$			80 A
$I_{SM}$	Repetitive, Pulse Width Limited by $T_{JM}$			320 A
$V_{SD}$	$I_F = I_S, V_{GS} = 0\text{V}$ , Note 1			1.4 V
$t_{rr}$	$I_F = 40\text{A}, -di/dt = 100\text{A}/\mu\text{s}$ $V_R = 100\text{V}, V_{GS} = 0\text{V}$			250 ns
$Q_{RM}$			1.8	$\mu\text{C}$
$I_{RM}$			15.6	A

Note 1. Pulse test,  $t \leq 300\mu\text{s}$ , duty cycle,  $d \leq 2\%$ .

IXYS Reserves the Right to Change Limits, Test Conditions, and Dimensions.

IXYS MOSFETs and IGBTs are covered by one or more of the following U.S. patents:	4,835,592	4,931,844	5,049,961	5,237,481	6,162,665	6,404,065 B1	6,683,344	6,727,585	7,005,734 B2	7,157,338B2
	4,860,072	5,017,508	5,063,307	5,381,025	6,259,123 B1	6,534,343	6,710,405 B2	6,759,692	7,063,975 B2	
	4,881,106	5,034,796	5,187,117	5,486,715	6,306,728 B1	6,583,505	6,710,463	6,771,478 B2	7,071,537	

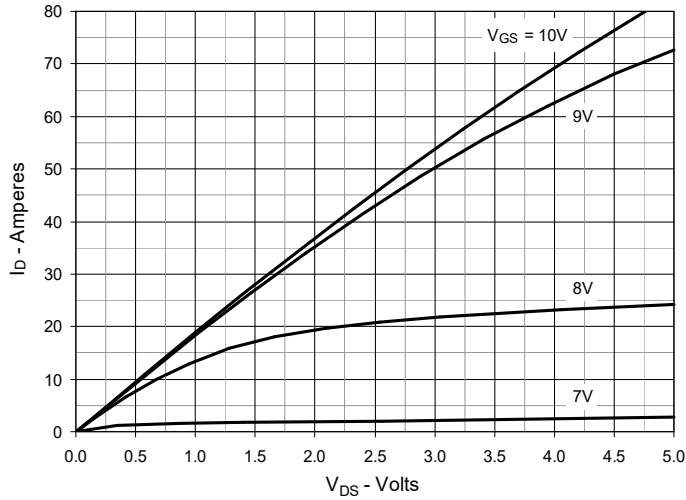
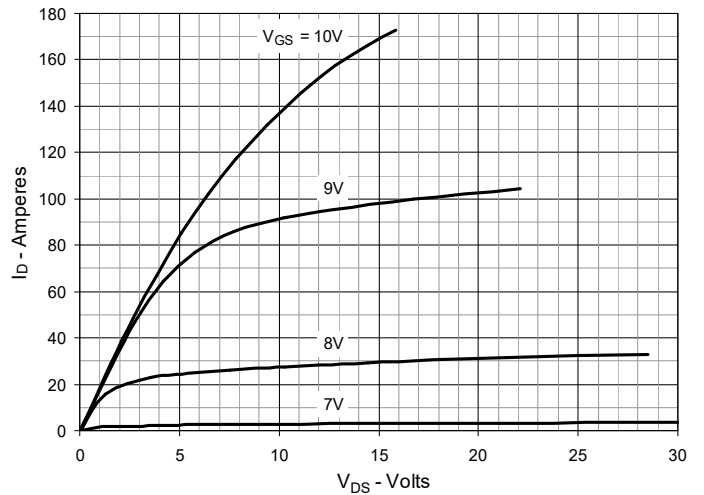
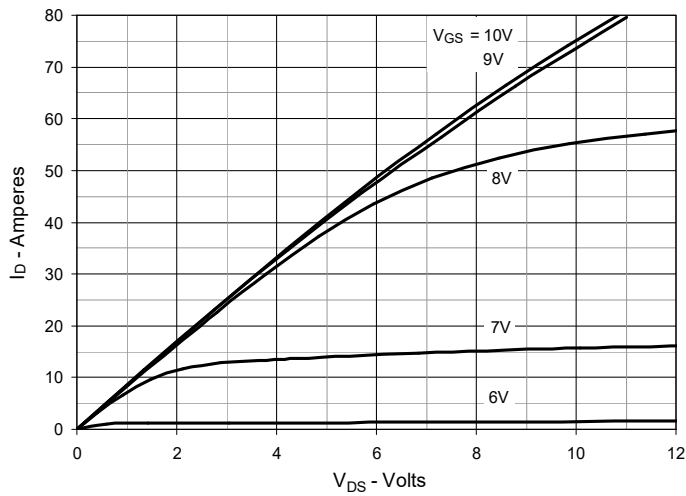
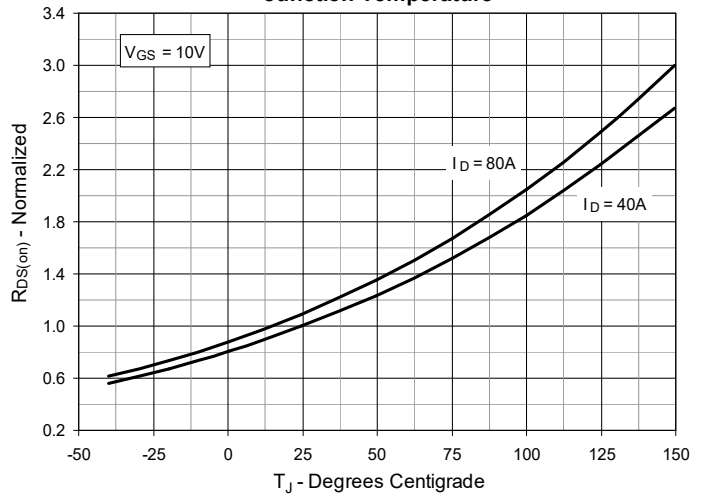
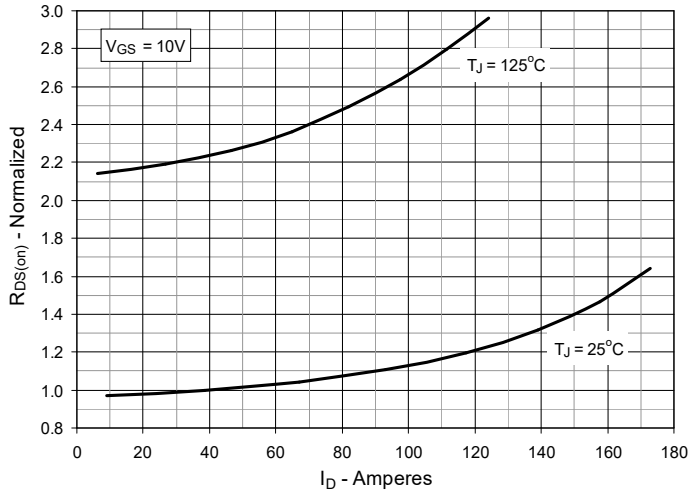
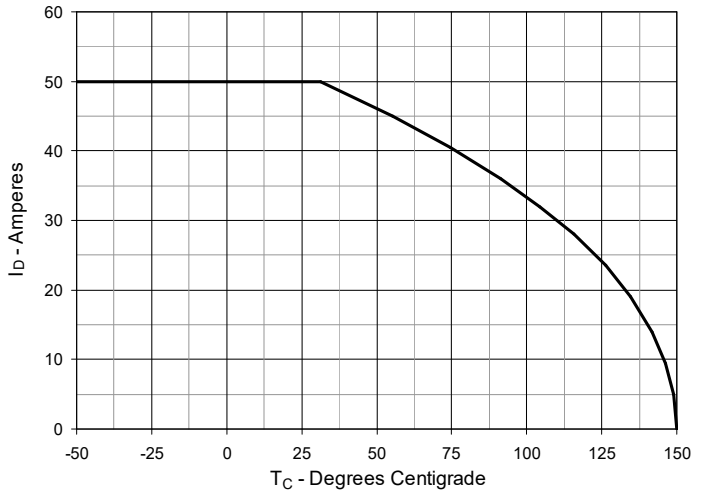
**Fig. 1. Output Characteristics @  $T_J = 25^\circ\text{C}$** 

**Fig. 2. Extended Output Characteristics @  $T_J = 25^\circ\text{C}$** 

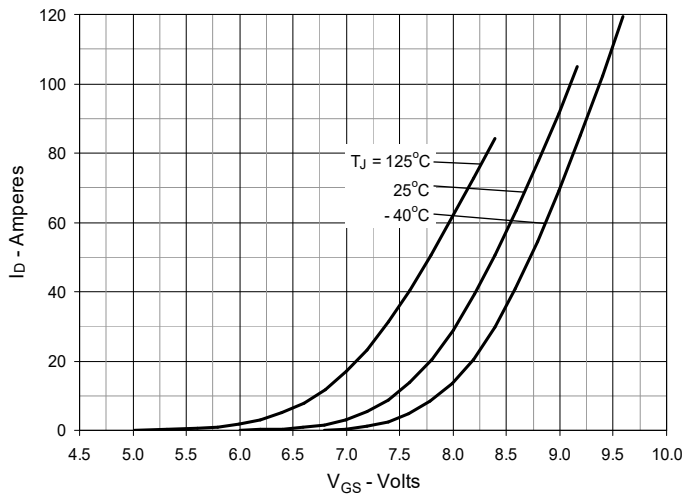
**Fig. 3. Output Characteristics @  $T_J = 125^\circ\text{C}$** 

**Fig. 4.  $R_{DS(on)}$  Normalized to  $I_D = 40\text{A}$  Value vs. Junction Temperature**

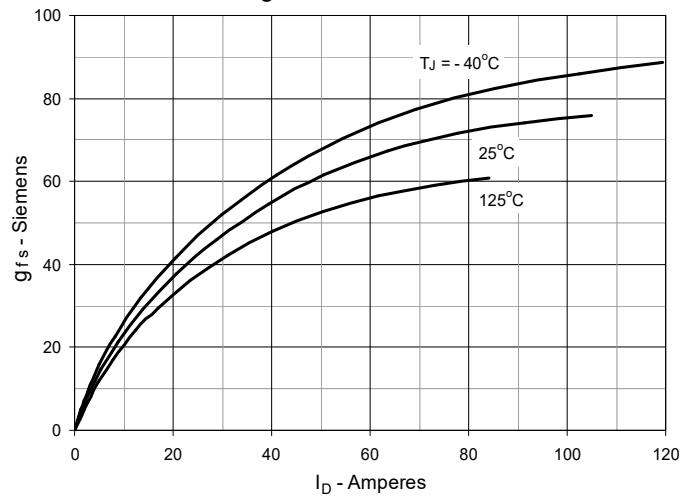
**Fig. 5.  $R_{DS(on)}$  Normalized to  $I_D = 40\text{A}$  Value vs. Drain Current**

**Fig. 6. Maximum Drain Current vs. Case Temperature**

**Fig. 7. Input Admittance**



**Fig. 8. Transconductance**



**Fig. 9. Forward Voltage Drop of Intrinsic Diode**

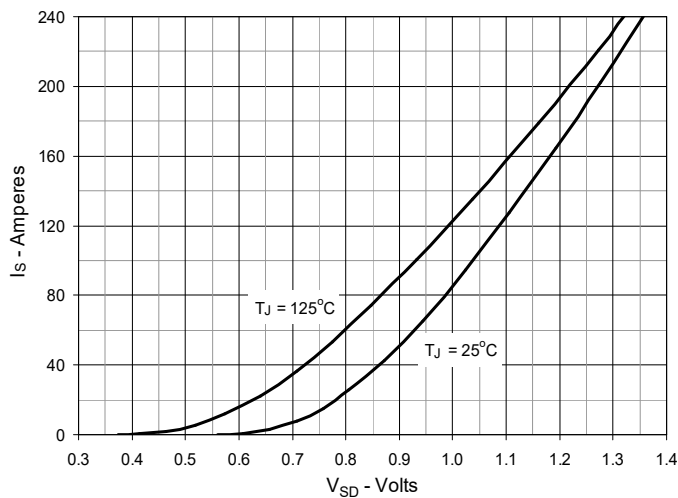

**Fig. 10. Gate Charge**

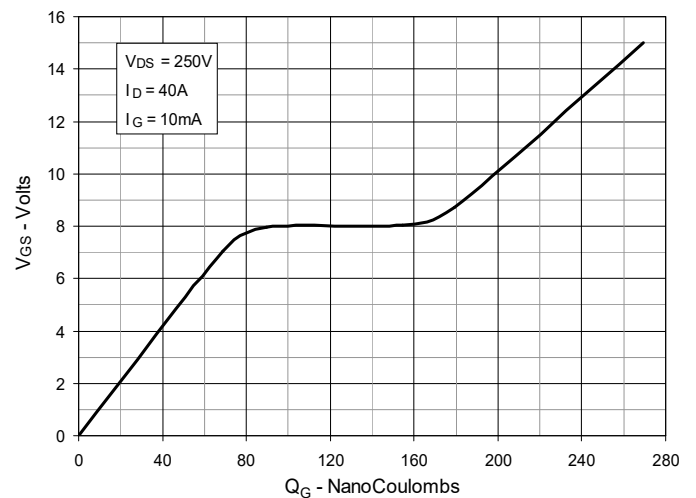

**Fig. 11. Capacitance**

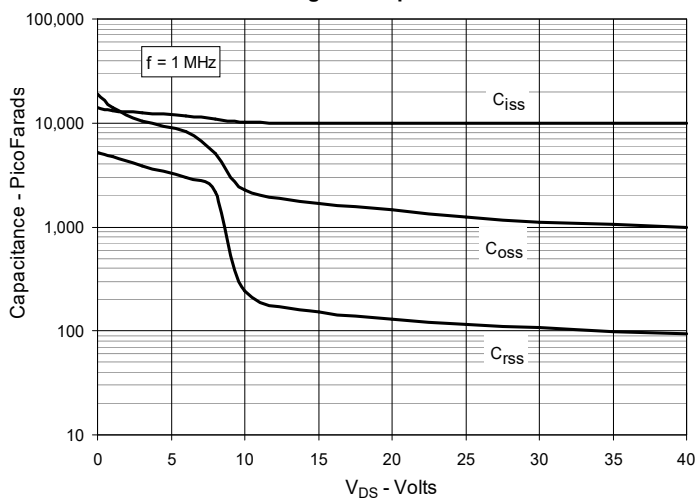

**Fig. 12. Forward-Bias Safe Operating Area**

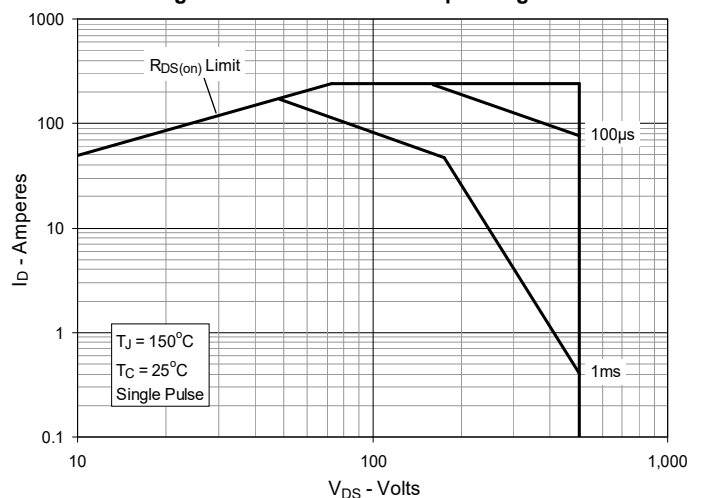
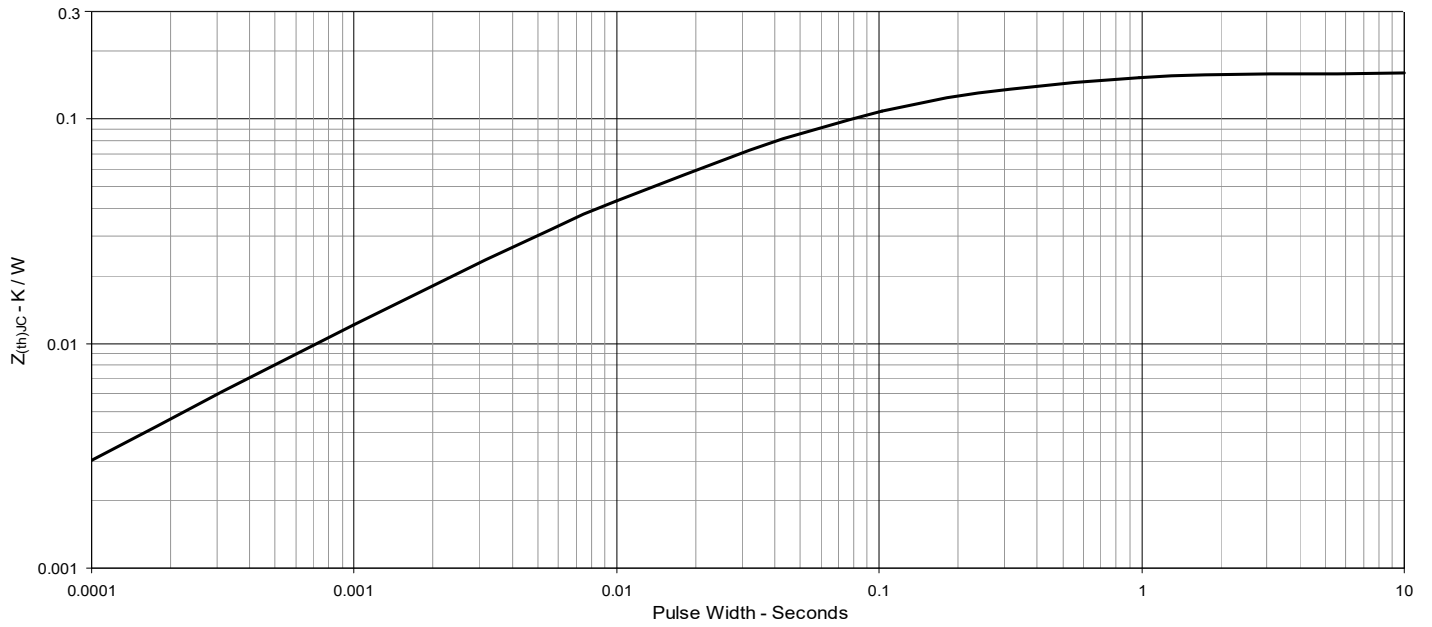
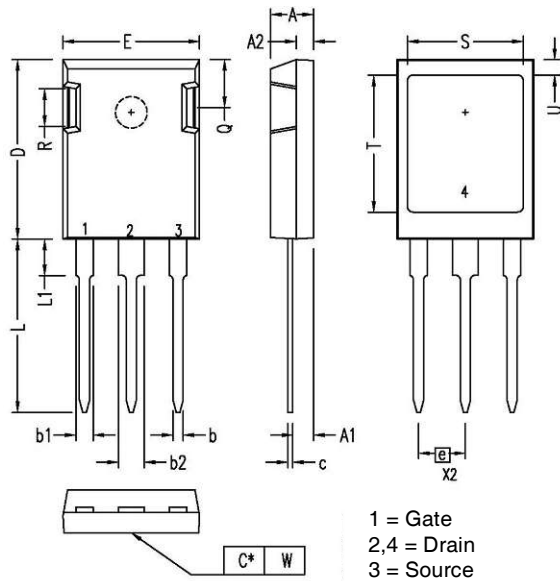

Fig. 13. Maximum Transient Thermal Impedance



**ISOPLUS247 (IXFR) Outline**

SYM	INCHES		MILLIMETERS	
	MIN	MAX	MIN	MAX
A	.190	.205	4.83	5.21
A1	.090	.100	2.29	2.54
A2	.075	.085	1.91	2.16
b	.045	.055	1.14	1.40
b1	.075	.085	1.91	2.15
b2	.115	.126	2.92	3.20
C	.024	.033	0.61	0.83
D	.819	.840	20.80	21.34
E	.620	.635	15.75	16.13
e	.215 BSC		5.45 BSC	
L	.780	.811	19.81	20.60
L1	.150	.172	3.81	4.38
Q	.220	.244	5.59	6.20
R	.170	.191	4.32	4.85
S	.520	.540	13.21	13.72
T	.620	.640	15.75	16.26
U	.065	.080	1.65	2.03
W	0	.004	0	0.10



---

Disclaimer Notice - Information furnished is believed to be accurate and reliable. However, users should independently evaluate the suitability of and test each product selected for their own applications. Littelfuse products are not designed for, and may not be used in, all applications. Read complete Disclaimer Notice at [www.littelfuse.com/disclaimer-electronics](http://www.littelfuse.com/disclaimer-electronics).

---