

Power Amplifier, 0.25 W DC - 27 GHz



MAAP-011324

Rev. V2

Features

- High Gain: 18.0 dB
- P1dB: 25.5 dBm
- P3dB: 27 dBm
- Output IP3: 34.5 dBm
- Bias Voltage: $V_{DD} = 8\text{ V}$
- Bias Current: $I_{DSQ} = 220\text{ mA}$
- 50 Ω Matched Input / Output
- Temperature Compensated Output Power Detector
- Lead-Free 5 mm 32-lead AQFN Package
- RoHS* Compliant

Applications

- Test & Measurement
- EW, ECM, and Radar

Description

The MAAP-011324 is a 0.25 W distributed power amplifier offered in a lead-free 5 mm 32-lead AQFN package. The power amplifier operates from DC to 27 GHz and provides 18 dB of linear gain and 27 dBm of output power at 3-dB compression. The device is fully matched across the band and includes a temperature compensated output power detector.

The MAAP-011324 can be used as a power amplifier stage or as a driver stage in higher power applications.

Ordering Information¹

Part Number	Package
MAAP-011324-TR0500	500 piece reel
MAAP-011324-TR1000	1000 piece reel
MAAP-011324-SMB	Sample Board

1. Reference Application Note M513 for reel size information.

Functional Schematic

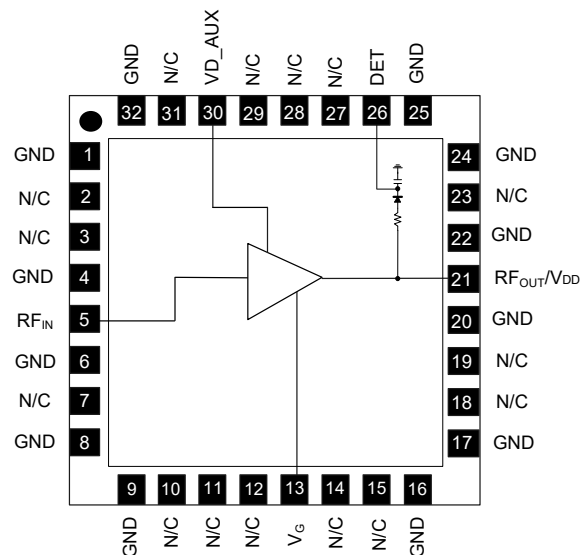

Pin Configuration^{2,3}

Pin #	Pin Name	Description
1, 4, 6, 8, 9, 16, 17, 20, 22, 24, 25, 32	GND	Ground
2, 3, 7, 10 - 12, 14, 15, 18, 19, 23, 27 - 29, 31	N/C	No Connection
5	RF _{IN}	RF Input
13	V _G	Gate Voltage
21	RF _{OUT} / V _{DD}	RF Output / Drain Voltage
26	DET	Power Detector
30	VD_AUX	VD_Auxiliary

2. MACOM recommends connecting all no connection pins to ground.
3. The exposed pad centered on the package bottom must be connected to RF, DC and thermal ground.

* Restrictions on Hazardous Substances, compliant to current RoHS EU directive.

Electrical Specifications: $T_A = +25^\circ\text{C}$, $V_{DD} = 8\text{ V}$, $I_{DSQ} = 220\text{ mA}$, $Z_0 = 50\ \Omega$

Parameter	Test Conditions	Units	Min.	Typ.	Max.
Gain	2 GHz	dB	17.0	18.5	—
	12 GHz		16.5	18.0	
	22 GHz		17.0	18.5	
	27 GHz		—	17.5	
P_{OUT}	$P_{IN} = +10\text{ dBm}$	dBm	—	28.5	—
	2 GHz			27.0	
	12 GHz			23.5	
	22 GHz			20.5	
P1dB	2 GHz	dBm	24.0	26.0	—
	12 GHz		22.5	24.0	
	22 GHz		19.5	21.5	
	27 GHz		—	19.5	
OIP3	$P_{out} = +13\text{ dBm/ tone (10 MHz Tone Spacing)}$	dBm	—	37.5	—
	2 GHz			34.5	
	12 GHz			32.5	
	22 GHz			28.5	
PAE	$P_{IN} = +10\text{ dBm}$	%	—	26.5	—
	2 GHz			22.5	
	12 GHz			13.0	
	22 GHz			6.0	
Input Return Loss	$P_{IN} = -10\text{ dBm}$	dB	—	15	—
Output Return Loss	$P_{IN} = -10\text{ dBm}$	dB	—	15	—
I_{DD} (with RF drive)	$P_{IN} = +10\text{ dBm}$	mA	—	250	—
I_G	—	mA	—	4	—

Maximum Operating Ratings

Parameter	Rating
Input Power	13 dBm
Junction Temperature ^{4,5}	+150°C
Operating Temperature	-40°C to +85°C

- Operating at nominal conditions with junction temperature $\leq +150^\circ\text{C}$ will ensure MTTF $> 1 \times 10^6$ hours.
- Junction Temperature (T_J) = $T_C + \Theta_{JC} * ((V * I) - (P_{OUT} - P_{IN}))$
Typical thermal resistance (Θ_{JC}) = 10.8 °C/W.
 - For $T_C = +25^\circ\text{C}$,
 $T_J = +43.3^\circ\text{C @ } 8\text{ V, } 239\text{ mA, } P_{OUT} = 23.4\text{ dBm, } P_{IN} = 8\text{ dBm}$
 - For $T_C = +85^\circ\text{C}$,
 $T_J = +103.6^\circ\text{C @ } 8\text{ V, } 239\text{ mA, } P_{OUT} = 23\text{ dBm, } P_{IN} = 8\text{ dBm}$

Absolute Maximum Ratings^{6,7}

Parameter	Absolute Maximum
Input Power	25 dBm
Drain-Voltage	+10 V
Gate Voltage	-5 to 0 V
Junction Temperature ⁸	+175°C
Storage Temperature	-65°C to +125°C

- Exceeding any one or combination of these limits may cause permanent damage to this device.
- MACOM does not recommend sustained operation near these survivability limits.
- Junction temperature directly effects device MTTF. Junction temperature should be kept as low as possible to maximize lifetime.

Application Schematic

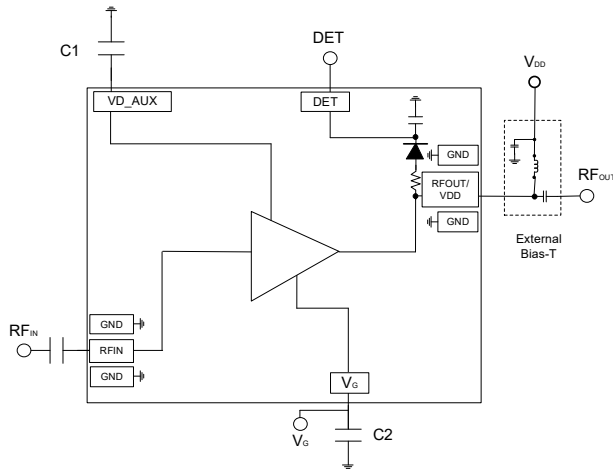

Operating the MAAP-011324

Turn-on

1. Apply V_{G1} (-4.5 V).
2. Increase V_{DD} to 8 V.
3. Set I_{DSQ} by adjusting V_G more positive (typically -0.53 V for $I_{DSQ} = 220$ mA).
4. Apply RF_{IN} signal.

Turn-off

1. Remove RF_{IN} signal.
2. Decrease V_G to -4.5 V.
3. Decrease V_{DD} to 0 V.

Bill of Materials^{9,10,11}

Part	Value	Size	Comment
C1, C2	1 μ F	0402	bypass

9. C1 & C2 are required for operation below 1 GHz.
10. High power external bias tee was used for measurements.
11. External DC block was used on input.

Biasing Conditions

Recommended biasing conditions are $V_{DD} = 8$ V, $I_{DSQ} = 220$ mA (controlled with V_G).

By-pass capacitor C1 for the auxiliary pad is for a low frequency operation extension (below 1 GHz). This provides wide band performance of 100 kHz - 27 GHz (depending on the bandwidth of the bias tees).

To bias the drain:

1. The required V_{DD} is applied at RF_{OUT}/V_{DD} through the bias tee.

There are 2 possible methods to bias the gate:

1. V_G is applied using the V_G pad (pin 12) and set using to provide the required current bias (I_{DSQ}). No external bias tee is required at the RF input but an external DC block is required.
2. V_G is applied at the RF input (pin 2) through an external bias tee on the RF input line and set to provide the required current bias (I_{DSQ}).

Handling Procedures

Please observe the following precautions to avoid damage:

Static Sensitivity

These electronic devices are sensitive to electrostatic discharge (ESD) and can be damaged by static electricity. Proper ESD control techniques should be used when handling these HBM Class 1B devices.

Recommended PCB Information

RF input and output are 50 Ω transmission lines. Single layer 8 mil Rogers RO4008 with 1/2 oz. Cu. Use copper filled vias under ground paddle.

Grounding

It is recommended that the total ground (common mode) inductance not exceed 0.03 nH (30 pH). This is equivalent to placing at least four 8-mil (200- μ m) diameter vias under the device, assuming an 8-mil (200- μ m) thick RF layer to ground.

Sample Board Layout

R1 is a zero ohm resistor and vias underneath package need to be solid copper filled and plated over. Do not use copper paste for vias. The MACOM sample board uses 81 vias underneath the IC. Gerber files are available upon request.

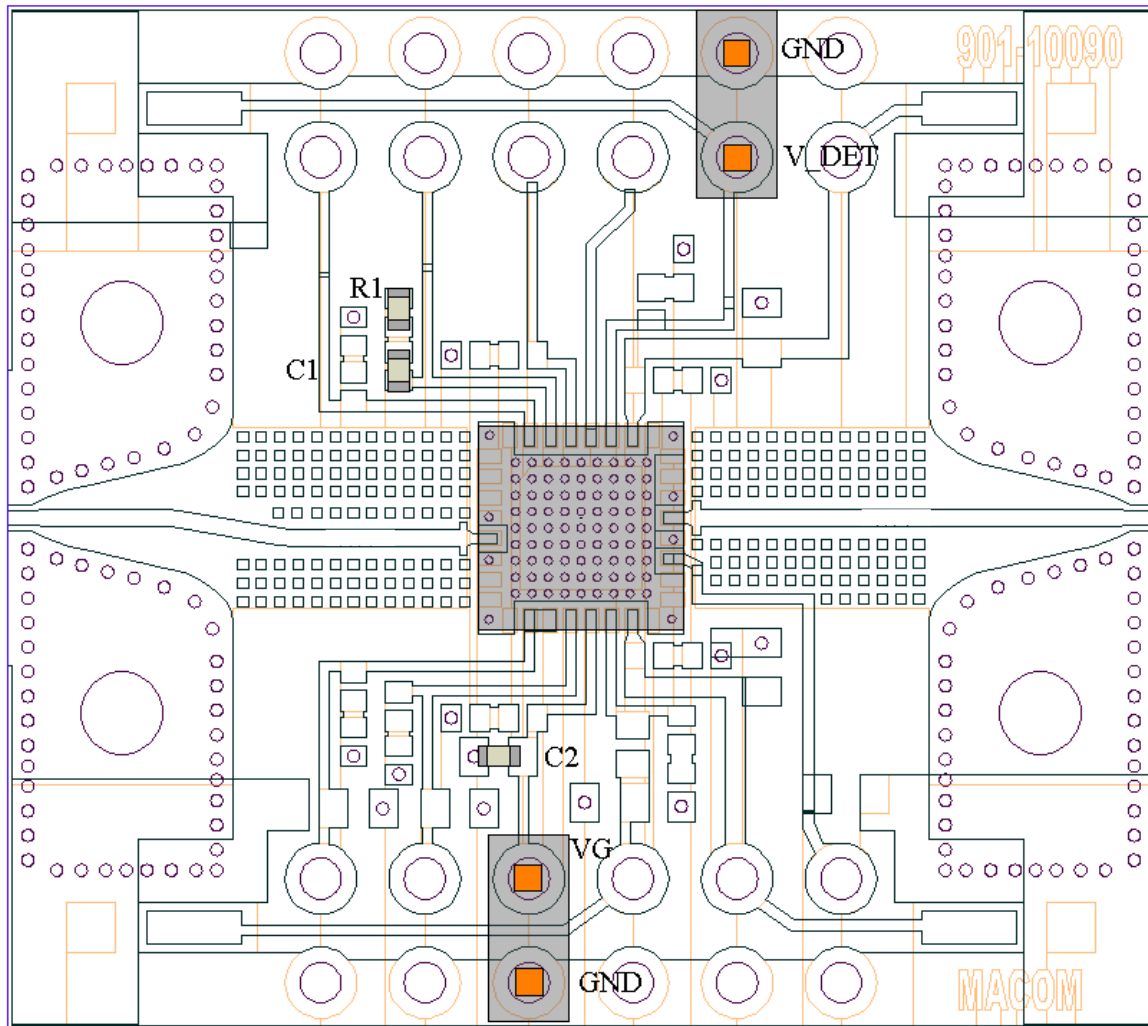

Sample Board Material Specifications

Top Layer: 1/2 oz Copper Cladding, 0.017 mm thickness
Dielectric Layer: Rogers RO4003C 0.203 mm thickness
Bottom Layer: 1/2 oz Copper Cladding, 0.017 mm thickness

Typical Performance Curves $V_{DD} = 8\text{ V}$, $I_{DSQ} = 220\text{ mA}$, $V_G = -0.53\text{ V}$ typical

S Parameters

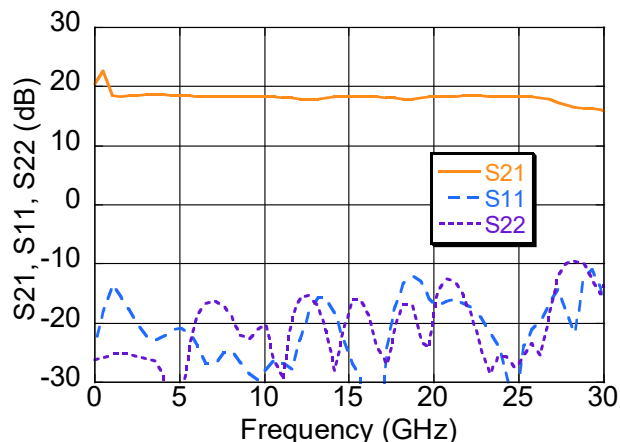

Gain

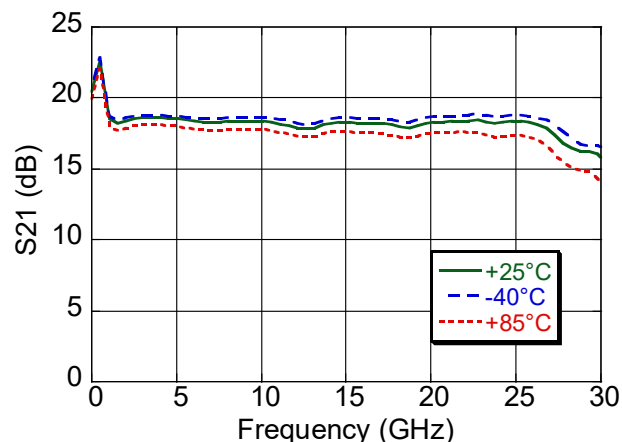

Input Return Loss

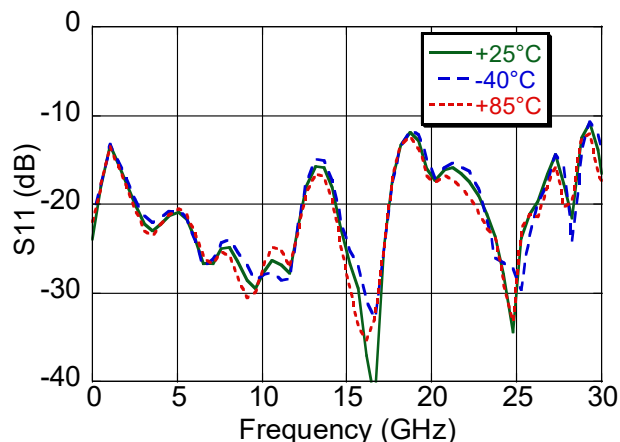

Output Return Loss

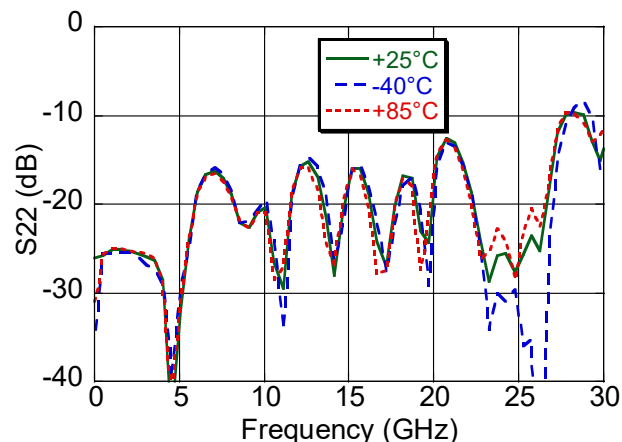

Isolation

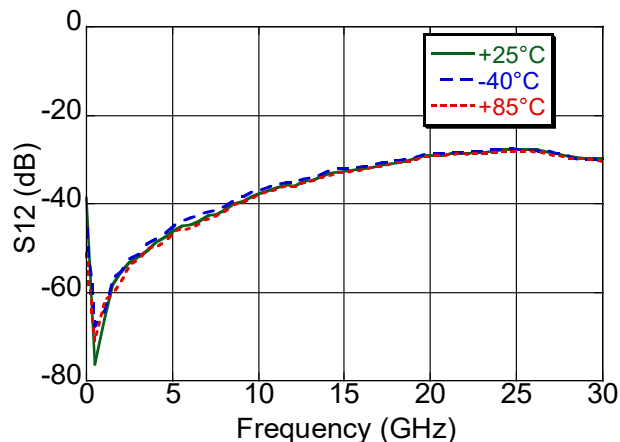

Typical Performance Curves $V_{DD} = 8\text{ V}$, $I_{DSQ} = 220\text{ mA}$, $V_G = -0.53\text{ V}$ typical

Noise Figure over Temperature

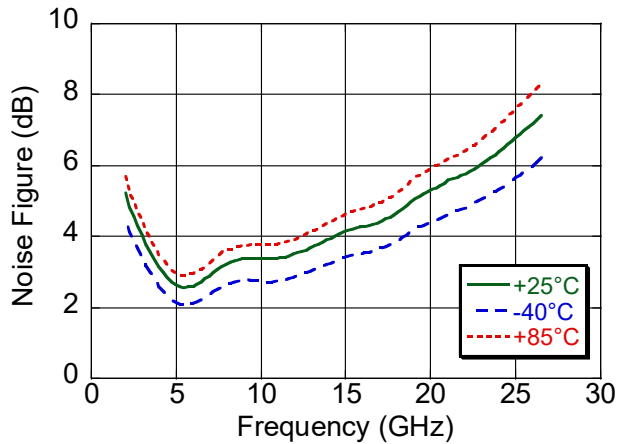

P1dB over Temperature

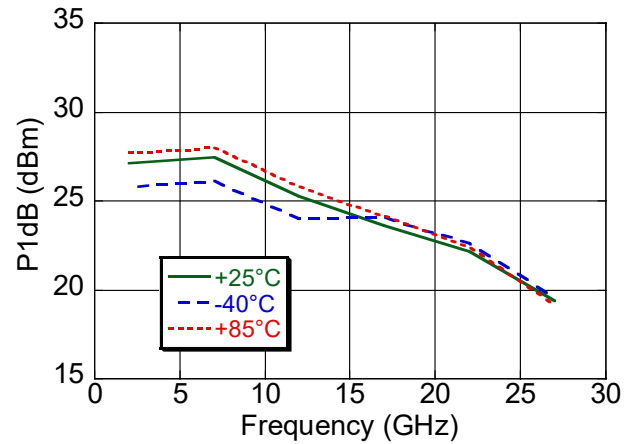

P_{SAT} over Temperature

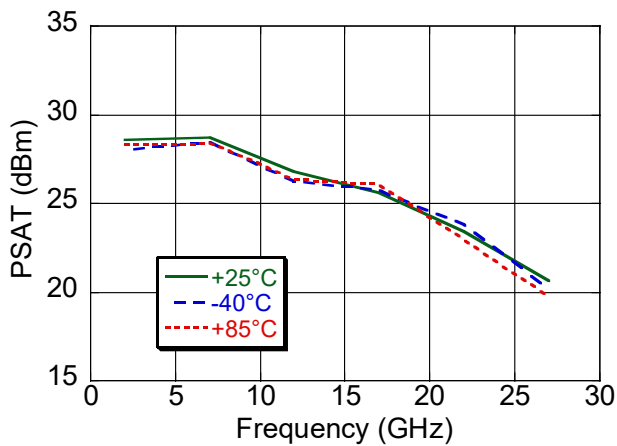

Output IP3 over Temperature @ 14 dBm per tone

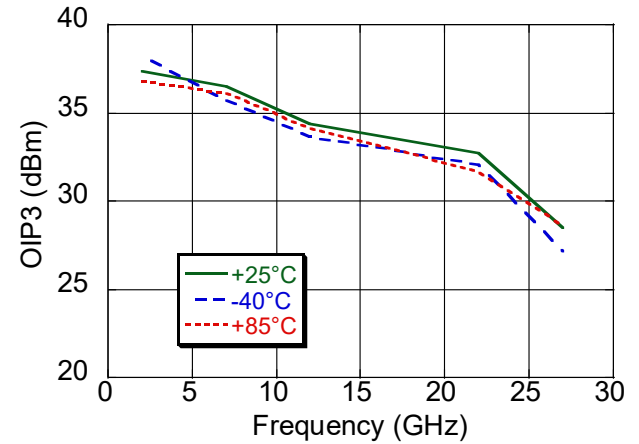

2nd Harmonic

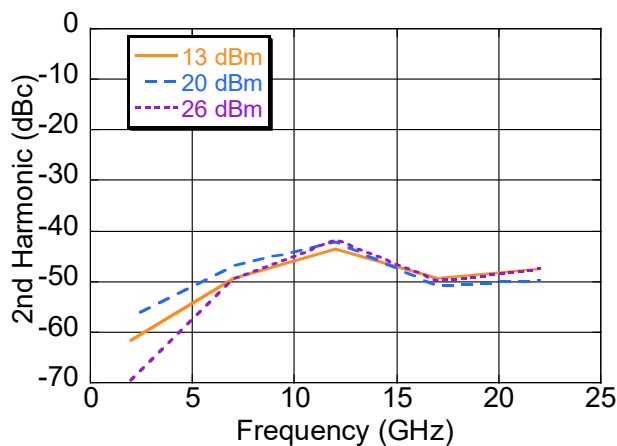

Detected Voltage

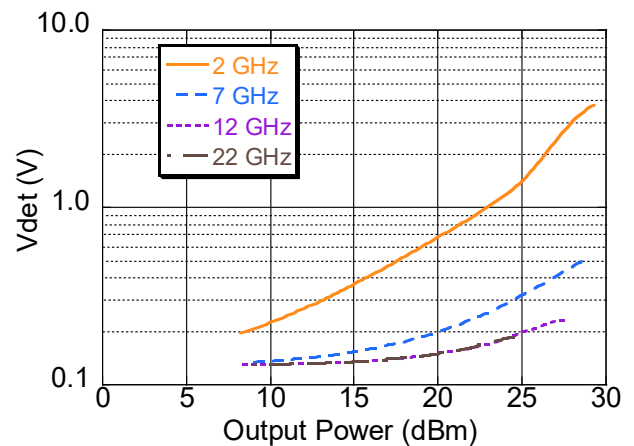

Typical Performance Curves $V_{DD} = 8\text{ V}$, $I_{DSQ} = 220\text{ mA}$, $V_G = -0.53\text{ V}$ typical

Power Compression @ 2 GHz

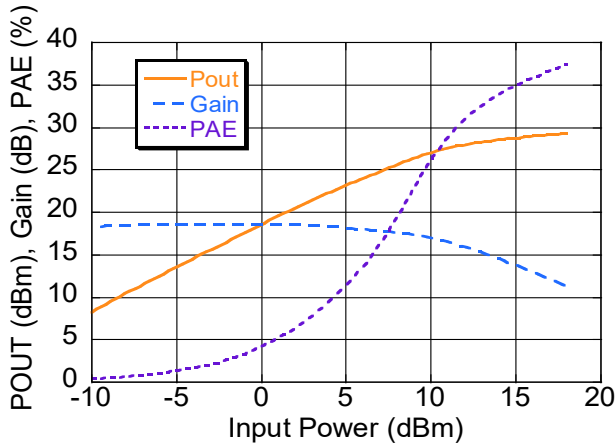

Power Compression @ 12 GHz

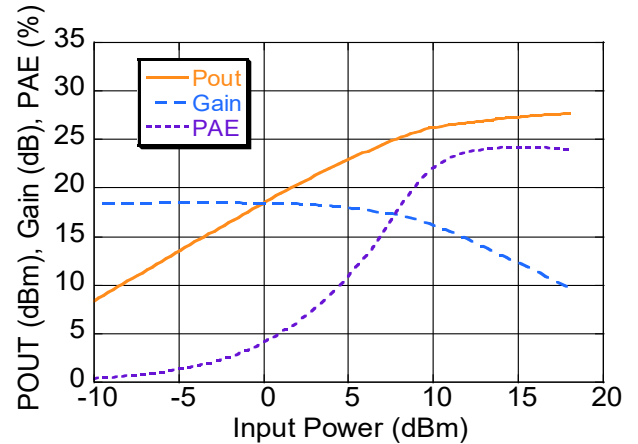

Power Compression @ 22 GHz

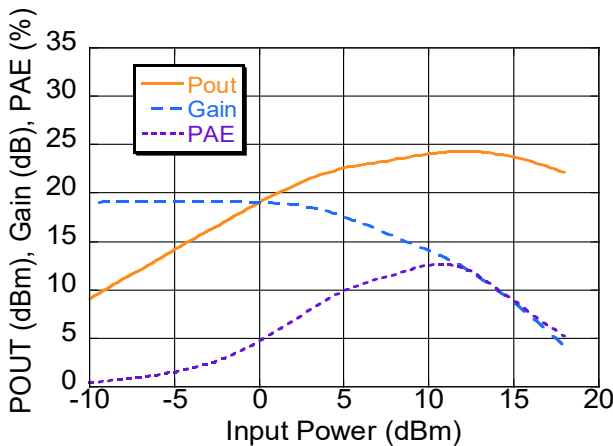

Power Compression @ 27 GHz

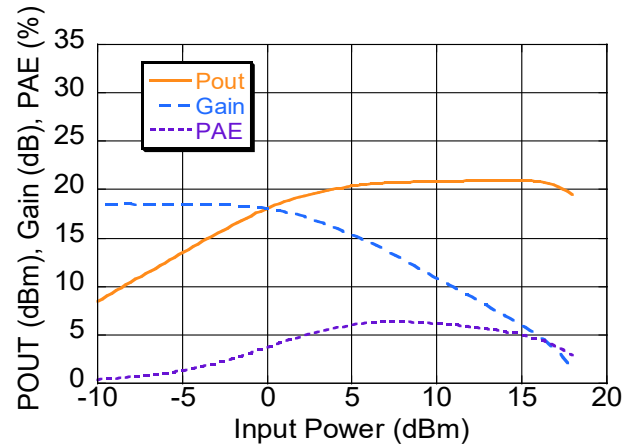

Current

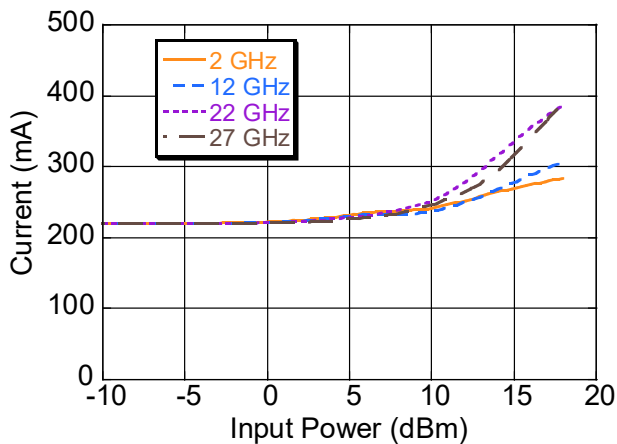

Test Board Loss including Connector

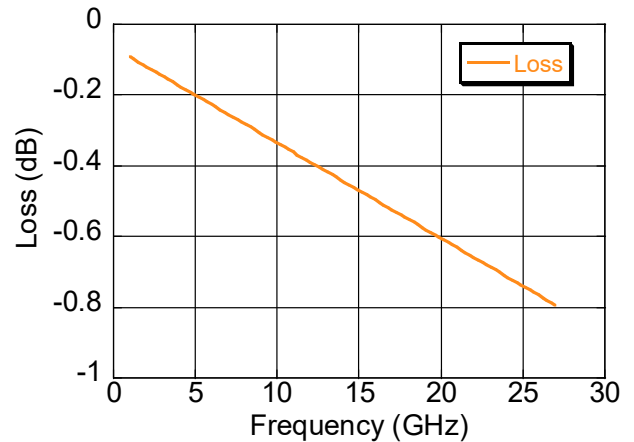

Lead-Free 5 mm 32-lead AQFN Package[†]

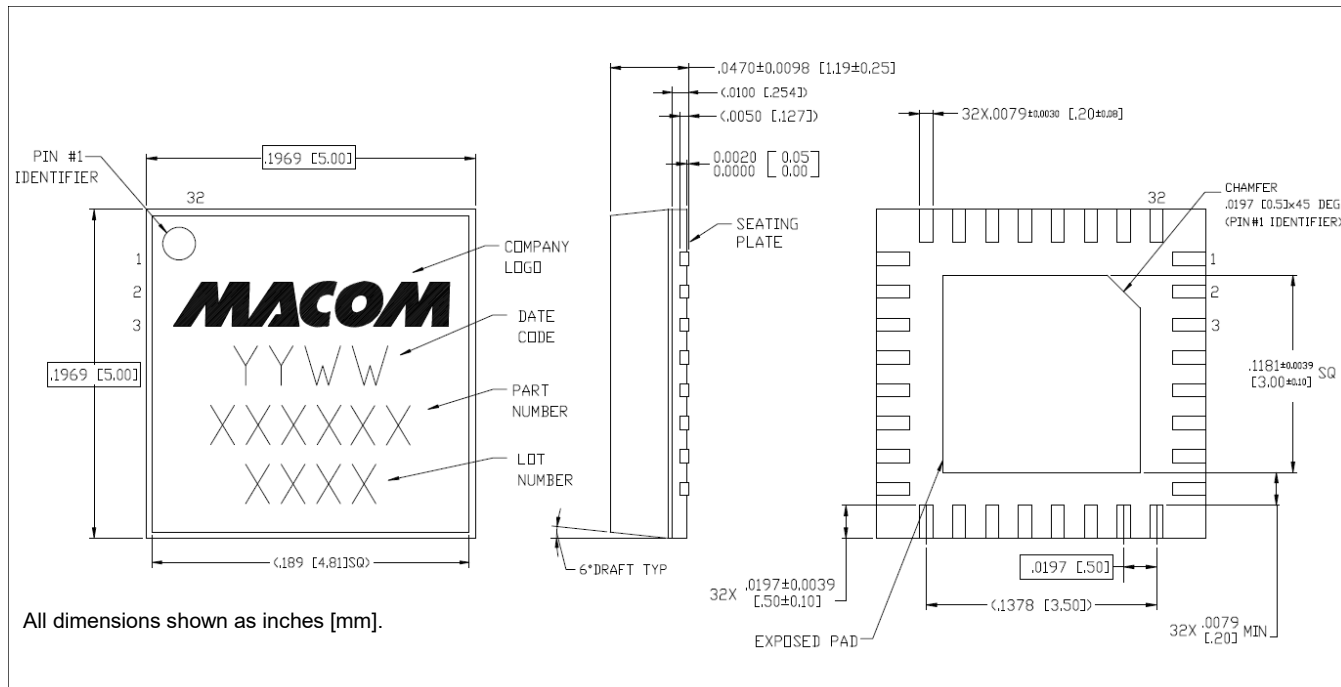

[†] Reference Application Note S2083 for lead-free solder reflow recommendations.
Meets JEDEC moisture sensitivity level 3 requirements.
Plating is NiPdAu.

MACOM Technology Solutions Inc. ("MACOM"). All rights reserved.

These materials are provided in connection with MACOM's products as a service to its customers and may be used for informational purposes only. Except as provided in its Terms and Conditions of Sale or any separate agreement, MACOM assumes no liability or responsibility whatsoever, including for (i) errors or omissions in these materials; (ii) failure to update these materials; or (iii) conflicts or incompatibilities arising from future changes to specifications and product descriptions, which MACOM may make at any time, without notice. These materials grant no license, express or implied, to any intellectual property rights.

THESE MATERIALS ARE PROVIDED "AS IS" WITH NO WARRANTY OR LIABILITY, EXPRESS OR IMPLIED, RELATING TO SALE AND/OR USE OF MACOM PRODUCTS INCLUDING FITNESS FOR A PARTICULAR PURPOSE, MERCHANTABILITY, INFRINGEMENT OF INTELLECTUAL PROPERTY RIGHT, ACCURACY OR COMPLETENESS, OR SPECIAL, INDIRECT, INCIDENTAL, OR CONSEQUENTIAL DAMAGES WHICH MAY RESULT FROM USE OF THESE MATERIALS.

MACOM products are not intended for use in medical, lifesaving or life sustaining applications. MACOM customers using or selling MACOM products for use in such applications do so at their own risk and agree to fully indemnify MACOM for any damages resulting from such improper use or sale.