

ANNA-40-4-M

~20° medium beam with 4 optics

TECHNICAL SPECIFICATIONS:

Dimensions	Ø 40.0 mm
Height	10.7 mm
Fastening	glue, pin
Colour	clear
Box size	480 x 280 x 300 mm
Box weight	5.7 kg
Quantity in Box	760 pcs
ROHS compliant	yes ⓘ



MATERIAL SPECIFICATIONS:

Component	Type	Material	Colour
ANNA-40-4-M	Multi-lens	PMMA	clear

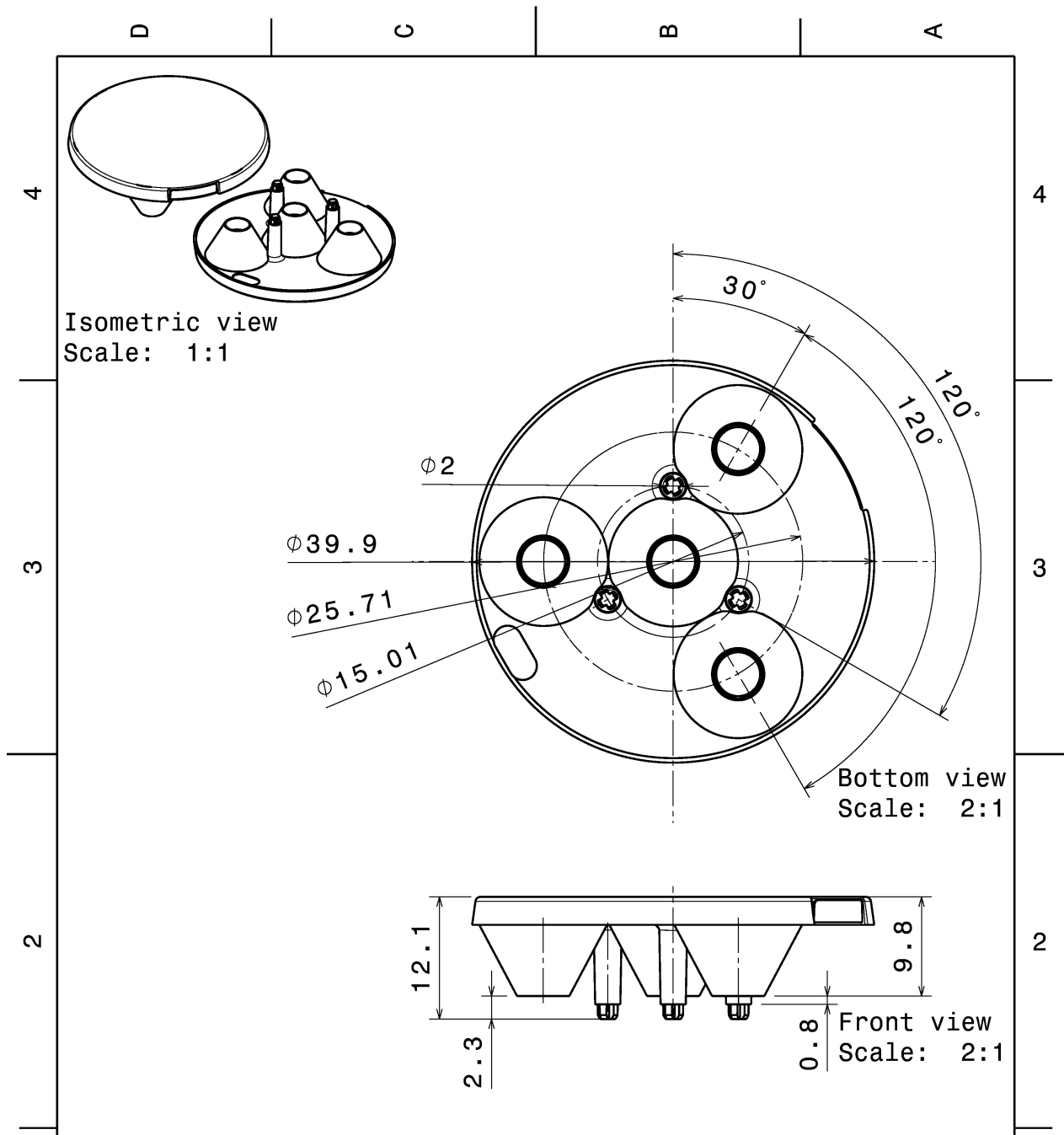

Tolerances if not otherwise shown
According to DIN ISO 2768-1
Linear measures:
Up to 30mm class M, otherwise class C.
According to DIN ISO 2768-2
Form and position: class L

LEDiL LediL Oy
Salorankatu 10
FIN 24240 SALO
Finland

THIRD ANGLE PROJECTION:

DRAWING TITLE
C11794_ANNA-40-4-M

This drawing is the property of LEDiL Oy. It may not be reproduced, copied or communicated without a written agreement with LEDiL Oy."

SIZE	PART NUMBER
A4	C11794

SCALE	2:1	WEIGHT	-	SHEET	1/1
-------	-----	--------	---	-------	-----

PHOTOMETRIC DATA (MEASURED):

CREE ⇄

LED XB-D
FWHM 22.0°
Efficiency 87 %
Peak intensity 3.450 cd/lm
LEDs/each optic 1
Light colour White
Required components:

CREE ⇄

LED XP-E
FWHM 19.0°
Efficiency 91 %
Peak intensity 5.200 cd/lm
LEDs/each optic 1
Light colour White
Required components:

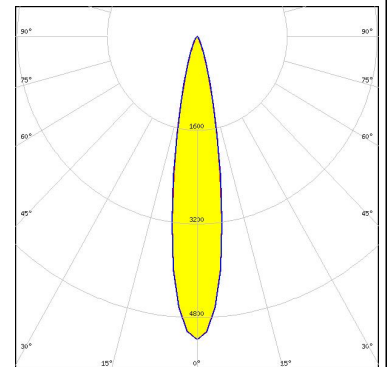

CREE ⇄

LED XP-G
FWHM 25.0°
Efficiency 91 %
Peak intensity 3.600 cd/lm
LEDs/each optic 1
Light colour White
Required components:

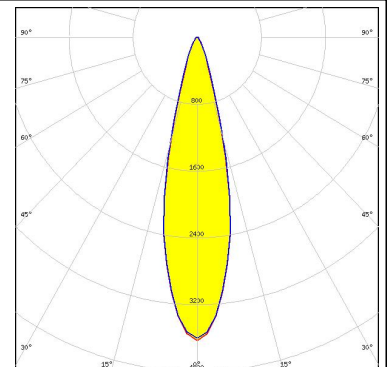

LUMILEDS

LED LUXEON A
FWHM 26.0°
Efficiency 84 %
Peak intensity 2.840 cd/lm
LEDs/each optic 1
Light colour White
Required components:

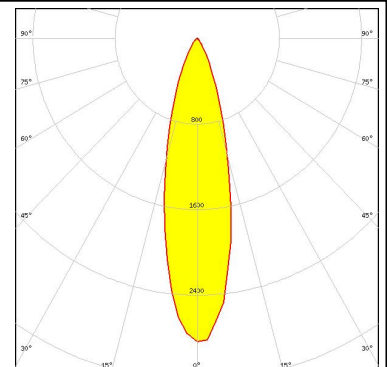

PHOTOMETRIC DATA (MEASURED):

LUMILEDS

LED LUXEON Rebel
 FWHM 18.0°
 Efficiency 87 %
 Peak intensity 5.000 cd/lm
 LEDs/each optic 1
 Light colour White
 Required components:

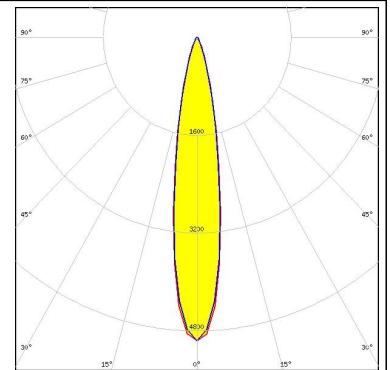

LUMILEDS

LED LUXEON Rebel ES
 FWHM 27.0°
 Efficiency 87 %
 Peak intensity 2.300 cd/lm
 LEDs/each optic 1
 Light colour White
 Required components:

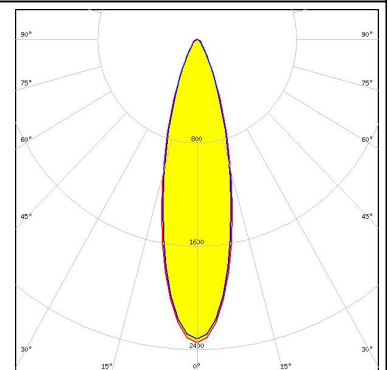

NICHIA

LED NCSxx19A
 FWHM 23.0°
 Efficiency 89 %
 Peak intensity 3.200 cd/lm
 LEDs/each optic 1
 Light colour White
 Required components:

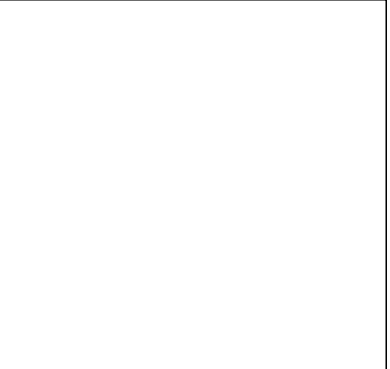

NICHIA

LED NF2x757A
 FWHM 20.0°
 Efficiency 90 %
 Peak intensity 4.080 cd/lm
 LEDs/each optic 1
 Light colour White
 Required components:

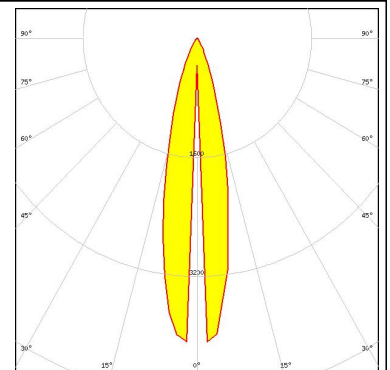

PHOTOMETRIC DATA (MEASURED):

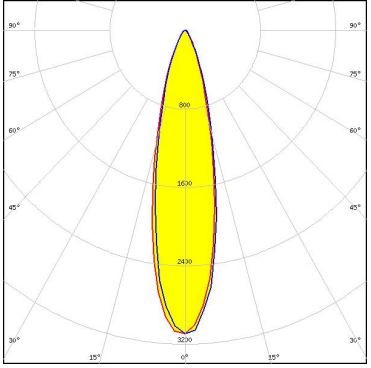
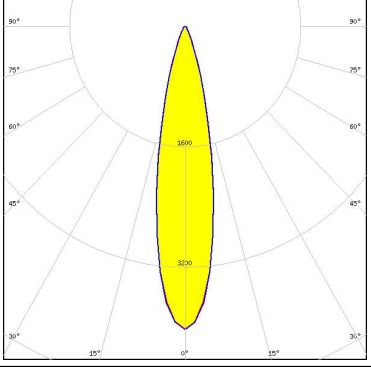
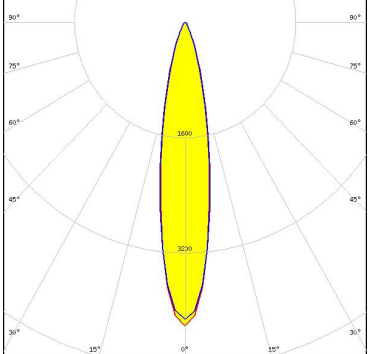
<p>NICHIA</p> <p>LED NVSxx19A FWHM 25.0° Efficiency 89 % Peak intensity 2.900 cd/lm LEDs/each optic 1 Light colour White Required components:</p>	
<p>OSRAM Opto Semiconductors</p> <p>LED Duris S5 (2 chip) FWHM 25.0° Efficiency 85 % Peak intensity 3.100 cd/lm LEDs/each optic 1 Light colour White Required components:</p>	
<p>OSRAM Opto Semiconductors</p> <p>LED Oslon SSL 150 FWHM 22.0° Efficiency 89 % Peak intensity 4.000 cd/lm LEDs/each optic 1 Light colour White Required components:</p>	
<p>OSRAM Opto Semiconductors</p> <p>LED Oslon SSL 80 FWHM 20.0° Efficiency 88 % Peak intensity 4.200 cd/lm LEDs/each optic 1 Light colour White Required components:</p>	

PHOTOMETRIC DATA (SIMULATED):

	
SEOUL SEMICONDUCTOR	
LED	Z5
FWHM	23.0°
Efficiency	%
Peak intensity	cd/lm
LEDs/each optic	1
Light colour	White
Required components:	
SHARP	
LED	Double Dome (GM2BB)
FWHM	24.0°
Efficiency	%
Peak intensity	cd/lm
LEDs/each optic	1
Light colour	White
Required components:	

GENERAL INFORMATION:

NOTE: The typical beam angle will be changed by different color, chip size and chip position tolerance. The typical total beam angle is the full angle measured where the luminous intensity is half of the peak value.

MATERIALS:

As part of our continuous research and improvement processes, and to ensure the best possible quality and availability of our products, LEDiL reserves the right to change material grades without notice.

PRODUCT DATA USER AGREEMENT AND DISCLAIMER:

The measured data in the provided downloadable LEDiL Product Datasheets and Mechanical 2D-Drawings is rounded and provided as reference for planning. LEDiL Oy's optical specifications have been verified by conducting performance testing of the products in accordance with the company's quality system. The reported data are averaged results of multiple measurements with typical variation. LEDiL Oy reserves the right to without prior notification make changes and improvements to its products.

LEDiL Oy assumes neither warranty, nor guarantee nor any other liability of any kind for the contents and correctness of the provided data. The provided data has been generated with highest diligence but the provided data may in reality not represent the complete possible variation range of all intrinsic parameters. Therefore, in certain cases a deviation from the provided data could occur.

LEDiL Oy reserves the right to undertake technical changes of its products without further notification which could lead to changes in the provided data. LEDiL Oy assumes no liability of any kind for the possible deviation from any provided data or any other damage resulting from the usage of the provided data.

The user agrees to this disclaimer and user agreement with the download or usage of the provided files.

LEDiL Oy

Joensuunkatu 13
FI-24240 SALO
Finland

LEDiL Inc.

228 West Page Street
Suite D
Sycamore IL 60178
USA

Local sales and technical support

[www.ledil.com/
where_to_buy](http://www.ledil.com/where_to_buy)

Shipping locations

Salo, Finland
Hong Kong, China

Distribution Partners

[www.ledil.com/
where_to_buy](http://www.ledil.com/where_to_buy)