

CMS80N06D-HF

N-Channel
RoHS Device
Halogen Free

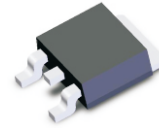

Features

- Low On-resistance.
- Low input capacitance.
- Low miller charge.
- Green device available.
- 100% EAS guaranteed.

Mechanical data

- Case: D-PAK/TO-252 standard package, molded plastic.

Circuit diagram

- G : Gate
- S : Source
- D : Drain

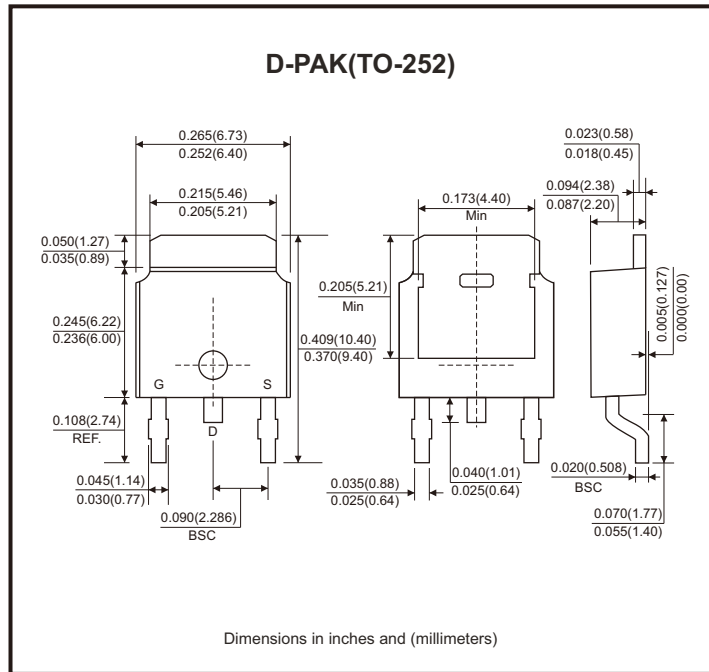
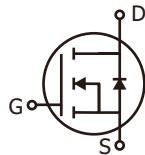

Maximum Ratings

Parameter	Conditions	Symbol	Value	Unit
Drain-source voltage		V_{DS}	60	V
Gate-source voltage		V_{GS}	± 20	V
Continuous drain current	$I_D @ T_C = 25^\circ C$		80	A
	$I_D @ T_C = 70^\circ C$		64	
Pulsed drain current (Note 1)		I_{DM}	180	A
Continuous drain current	$I_D @ T_A = 25^\circ C$		14	A
	$I_D @ T_A = 70^\circ C$		11.2	
Total power dissipation	$P_D @ T_C = 25^\circ C$		83	W
	$P_D @ T_A = 25^\circ C$		2.5	
Single pulse avalanche energy, L=0.3mH		E_{AS}	135	mJ
Single pulse avalanche current, L=0.3mH		I_{AS}	30	A
Operating junction temperature range		T_J	-55 to +150	$^\circ C$
Storage temperature range		T_{STG}	-55 to +150	$^\circ C$
Thermal resistance junction-ambient (Note 2)	Steady state	$R_{\theta JA}$	50	$^\circ C/W$
Thermal resistance junction-case (Note 2)	Steady state	$R_{\theta JC}$	1.5	$^\circ C/W$

Electrical Characteristics (at $T_J=25^\circ\text{C}$ unless otherwise noted)

Parameter	Symbol	Conditions	Min	Typ	Max	Unit
Drain-source breakdown voltage	BV_{DSS}	$V_{GS} = 0V, I_D = 250\mu A$	60			V
Gate threshold voltage	$V_{GS(th)}$	$V_{DS} = V_{GS}, I_D = 250\mu A$	2	3	4	
Gate-source leakage current	I_{GSS}	$V_{GS} = \pm 20V$			± 100	nA
Drain-source leakage current	I_{DSS}	$V_{DS} = 48V, V_{GS} = 0V$			1	μA
Static drain-source on-resistance (Note 1)	$R_{DS(on)}$	$V_{GS} = 10V, I_D = 20A$		5.5	7	m Ω
Total gate charge (Note 1)	Q_g	$I_D = 30A, V_{DS} = 30V, V_{GS} = 10V$		118		nC
Gate-source charge	Q_{gs}			28		
Gate-drain ("miller") charge	Q_{gd}			45		
Turn-on delay time (Note 1)	$t_{d(on)}$	$V_{DS} = 30V, V_{GS} = 10V$ $I_D = 30A, R_G = 3\Omega$		25		nS
Rise time	t_r			19		
Turn-off delay time	$t_{d(off)}$			85		
Fall time	t_f			43		
Input capacitance	C_{iss}	$V_{GS} = 0V, V_{DS} = 30V, f = 1MHz$		4871		pF
Output capacitance	C_{oss}			243		
Reverse transfer capacitance	C_{rss}			124		
Source-drain diode						
Diode forward voltage (Note 1)	V_{SD}	$V_{GS} = 0V, I_S = 30A$			1.3	V
Reverse recovery time	t_{rr}	$I_F = 30A, T_J = 25^\circ\text{C}$		36		nS
Reverse recovery charge	Q_{rr}	$dI/dt = 100A/\mu s$		53		nC
Guaranteed avalanche characteristics						
Single pulse avalanche energy (Note 3)	EAS	$V_{DD} = 25V, L = 0.3mH, I_{AS} = 21A$	66			mJ

Notes: 1. The data tested by pulsed, pulse width $\leq 300\mu s$, duty cycle $\leq 2\%$.

2. $R_{\theta JA}$ is the sum of the junction-to-case and case-to-ambient thermal resistance where the case thermal reference is defined as the solder mounting surface of the drain pins. $R_{\theta JC}$ is guaranteed by design while $R_{\theta CA}$ is determined by the user's board design.
 $R_{\theta JA}$ shown below for single device operation on FR-4 in still air.

3. The min. value is 100% EAS tested guarantee.

Rating and Characteristic Curves (CMS80N06D-HF)

Fig.1 - Typical Output Characteristics

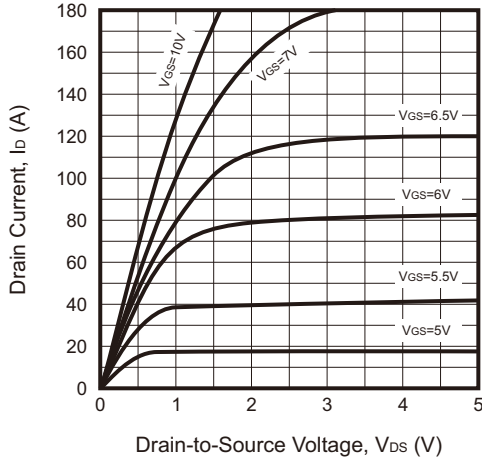

Fig.2 - On-Resistance vs. G-S Voltage

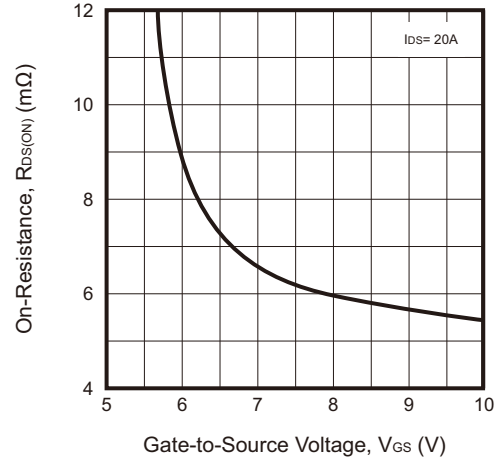

Fig.3 - On-Resistance vs. Drain Current

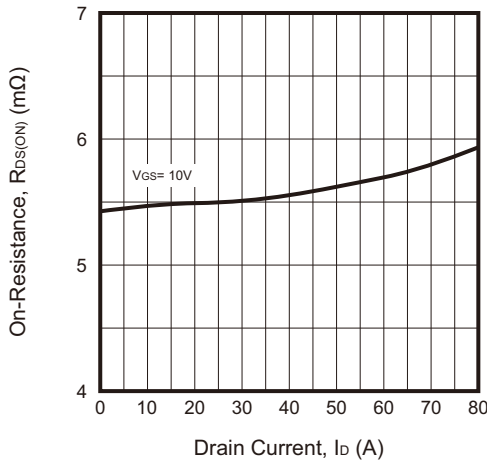

Fig.4 - Normalized $R_{DS(ON)}$ vs. T_J

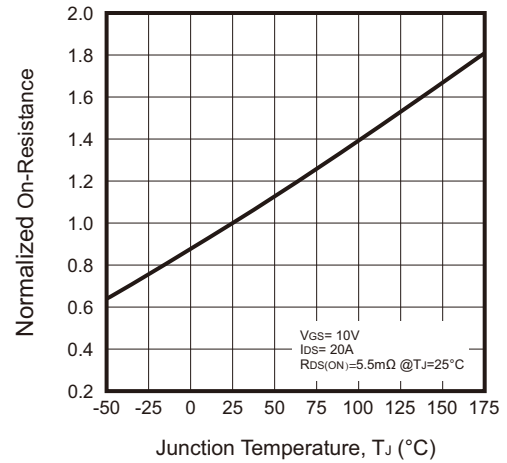

Fig.5 - Normalized $V_{GS(th)}$ vs. T_J

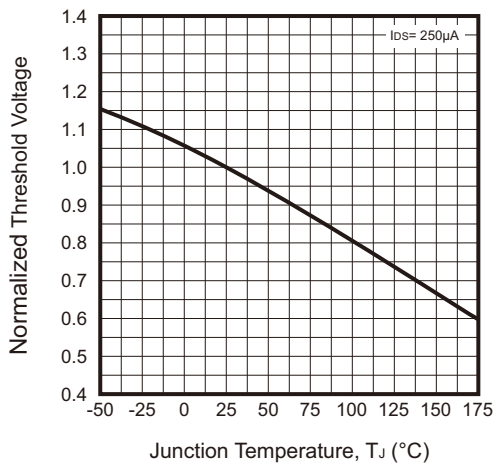
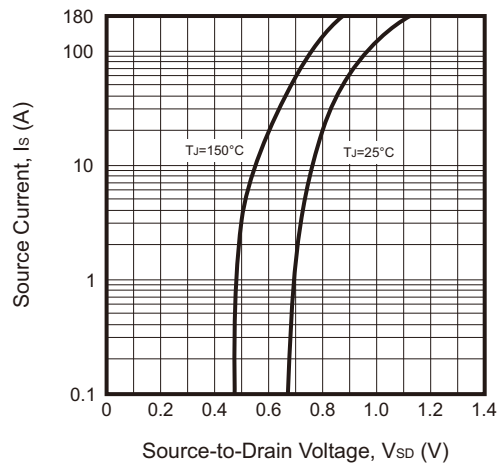

Fig.6 - Forward Characteristics of Reverse



Rating and Characteristic Curves (CMS80N06D-HF)

Fig.7 - Gate Charge Characteristics

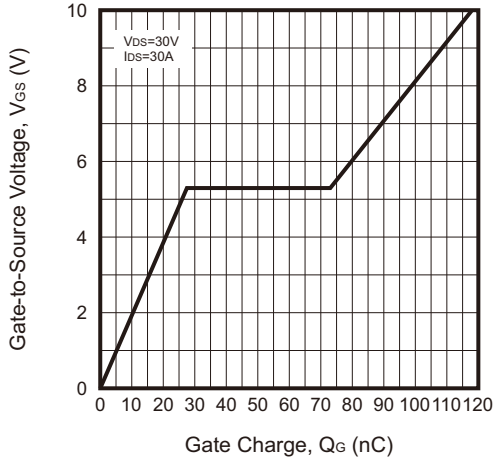

Fig.8 - Capacitance Characteristics

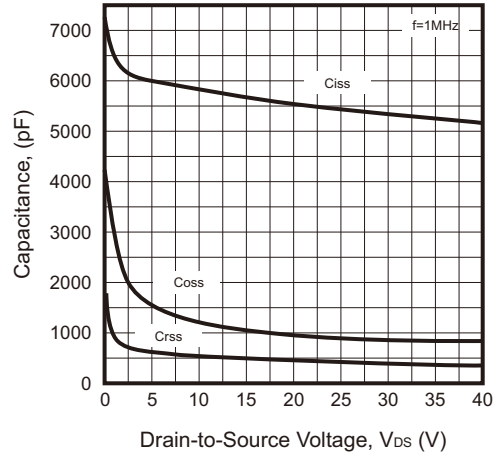

Fig.9 - Safe Operating Area

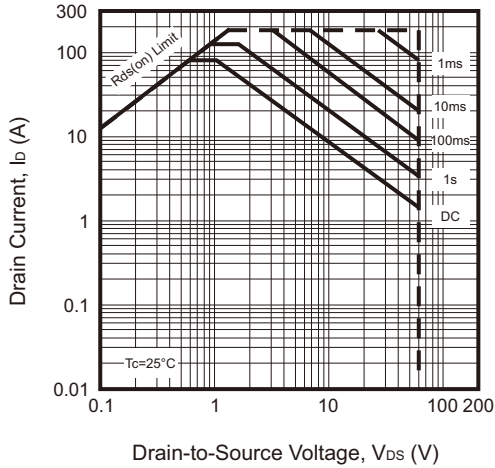

Fig.10 - Power Dissipation

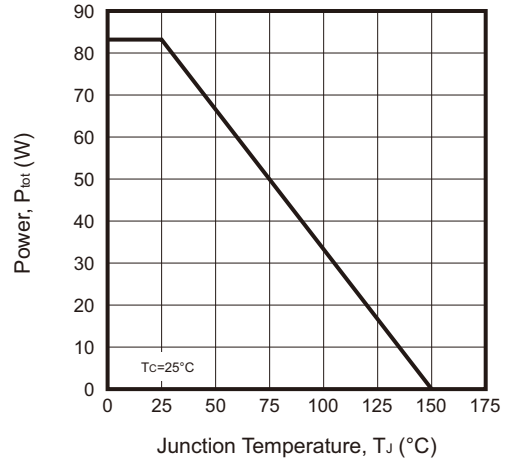
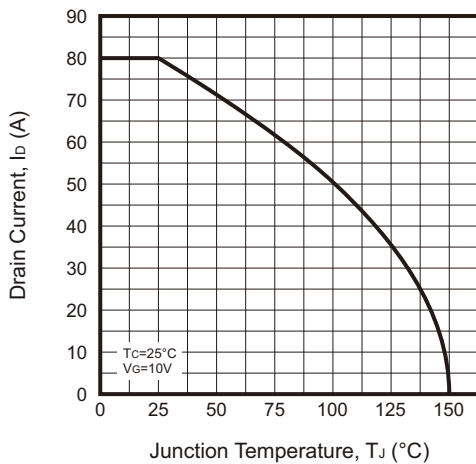
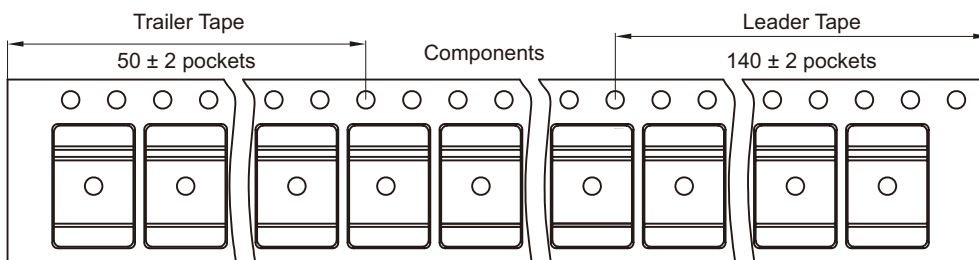
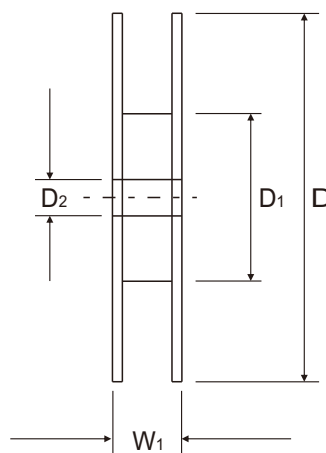
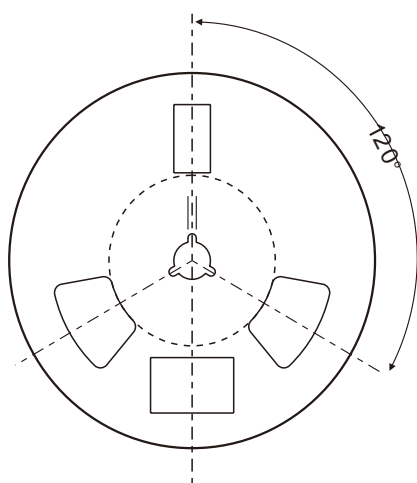
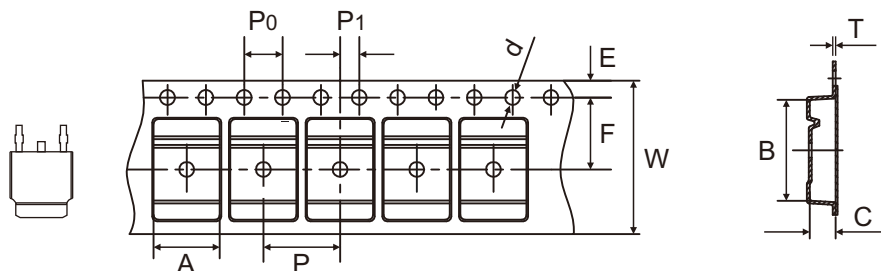

Fig.11 - Drain Current vs. T_J



Reel Taping Specification



TO-252 (D-PAK)	SYMBOL	A	B	C	d	D	D1	D2
	(mm)	6.90 ± 0.10	10.50 ± 0.10	2.70 ± 0.10	1.55 ± 0.05	332 Max	100.00 ± 2.00	13.00 Min
	(inch)	0.272 ± 0.004	0.413 ± 0.004	0.106 ± 0.004	0.061 ± 0.002	13.071 Max	3.937 ± 0.079	0.512 Min

TO-252 (D-PAK)	SYMBOL	E	F	P	P0	P1	T	W	W1
	(mm)	1.75 ± 0.10	7.50 ± 0.10	8.00 ± 0.10	4.00 ± 0.10	2.00 ± 0.10	0.30 ± 0.05	16.00 ± 0.10	22.4 Max
	(inch)	0.069 ± 0.004	0.295 ± 0.004	0.315 ± 0.004	0.157 ± 0.004	0.079 ± 0.004	0.012 ± 0.002	0.630 ± 0.004	0.882 Max

Company reserves the right to improve product design, functions and reliability without notice. REV:A

Marking Code

Part Number	Marking Code
CMS80N06D-HF	60N02

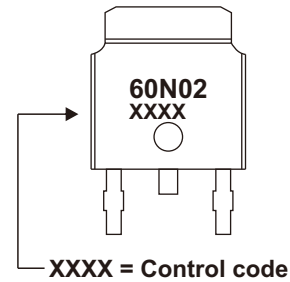

Suggested PAD Layout

SIZE	TO-252/D-PAK	
	(mm)	(inch)
A	6.00	0.236
B	6.50	0.256
C	3.00	0.118
D	1.40	0.055
E	6.25	0.246
F	4.60	0.181

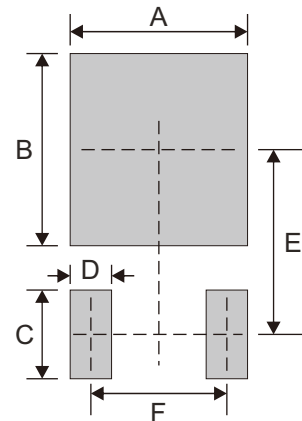

Note: 1. The pad layout is for reference purposes only.

Standard Packaging

Case Type	REEL PACK	
	REEL (pcs)	Reel Size (inch)
TO-252/D-PAK	3,000	13