

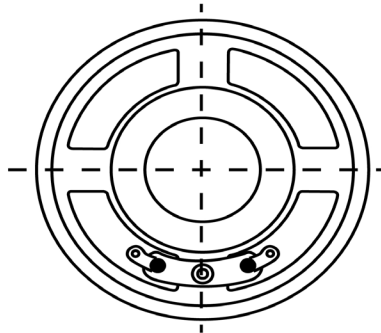

TOP VIEW

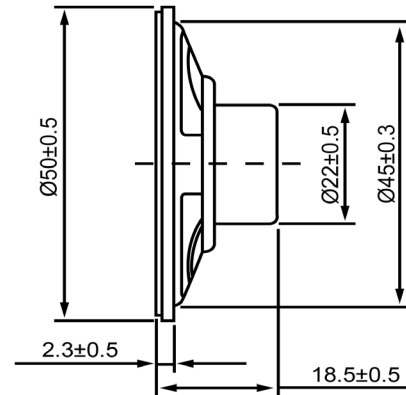

SIDE VIEW



Specifications			Notes	Revision History					
Description	Value	Unit		Version	Description	Date	Approved		
Shape	Round		1) All dimensions are in mm unless otherwise noted 2) All parts meet RoHS  DB UNLIMITED	1	Released from Engineering	2/5/2014	J.S.		
Resonant Frequency	550	(Hz)							
Frequency Range	550 ~ 4,500	(Hz)							
SPL @ 10cm	104	(dBA)							
Impedance	8	(Ohm)							
Cone Material	Paper								
Nominal Power	0.2	(W)							
Max Power	0.4	(W)							
Mount Type	Flush Mount								
Operating Temperature	-30 ~ +60	°C							
Storage Temperature	-30 ~ +60	°C							
Weight	31	(g)							
				Dynamic Speaker		SP500508-3			
				Drawn by	Date	Checked by	Date	Approved by	Date
				G.W.	1/27/2014	C.E.	2/5/2014	J.S.	2/5/2014