

FLARE-B

29 x 23 mm lens with ~100° x 10° oval beam

SPECIFICATION:

Dimensions	29.0 x 23.0 mm
Height	12.7 mm
Fastening	glue, screw
ROHS compliant	yes ⓘ

MATERIALS:

Component	Type	Material	Colour	Finish
FLARE-B	Single lens	PMMA	clear	

ORDERING INFORMATION:

Component	Qty in box	MOQ	MPQ	Box weight (kg)
C10946_FLARE-B » Box size: 460 x 250 x 300 mm	1792	224	224	8.6



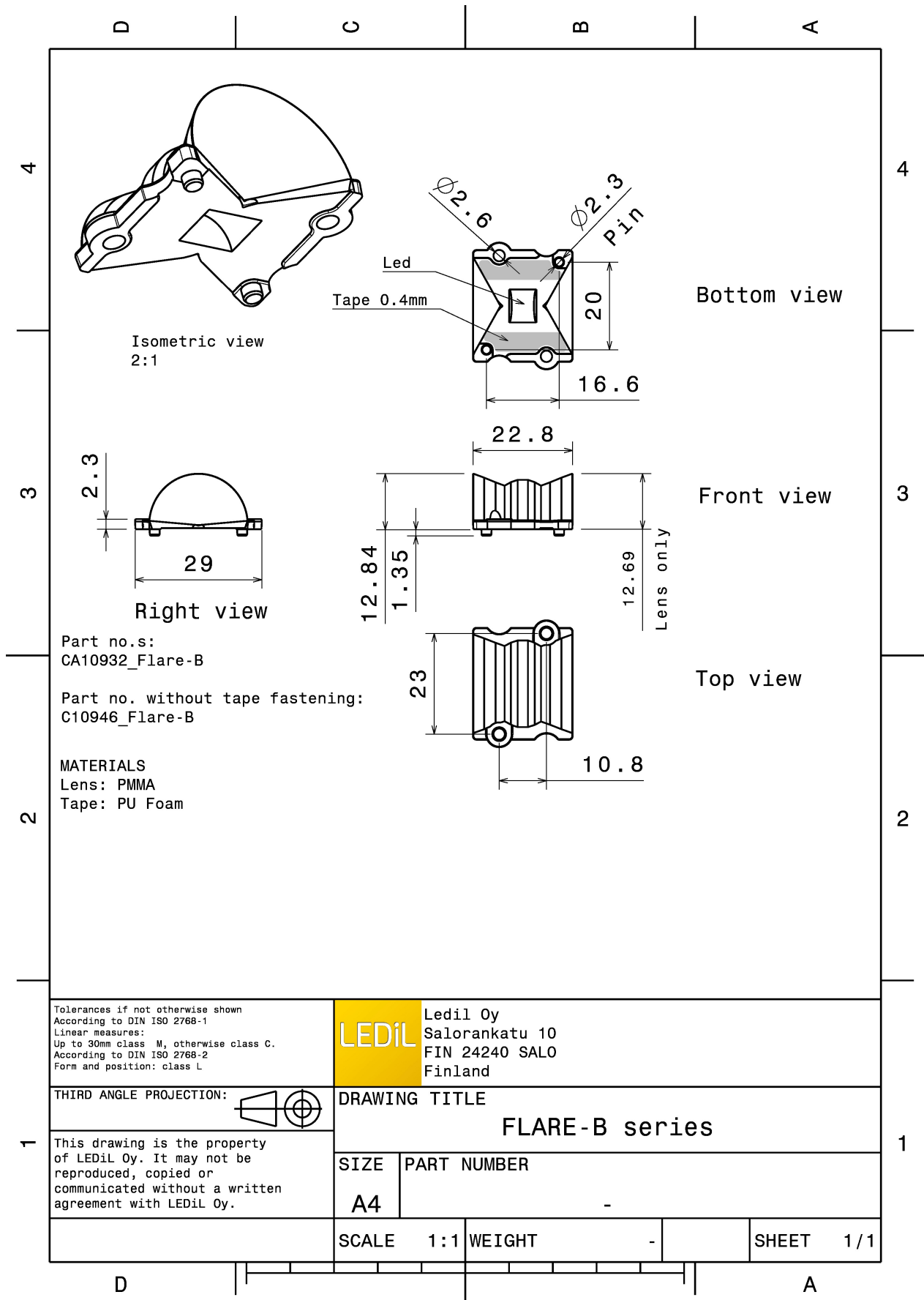

See also our general installation guide: www.ledil.com/installation_guide

OPTICAL RESULTS (MEASURED):

CREE LED

LED XB-D
 FWHM / FWTM 10.0 + 108.0° / 30.0 + 167.0°
 Efficiency 93 %
 Peak intensity 1.5 cd/lm
 LEDs/each optic 1
 Light colour White
 Required components:

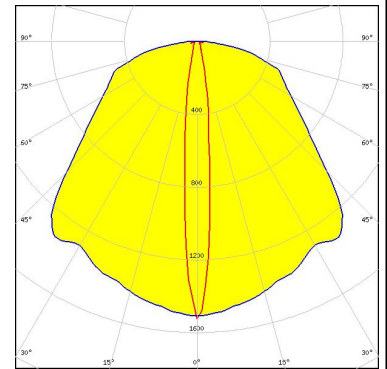

CREE LED

LED XP-E
 FWHM / FWTM 12.0 + 96.0°
 Efficiency 94 %
 LEDs/each optic 1
 Light colour White
 Required components:

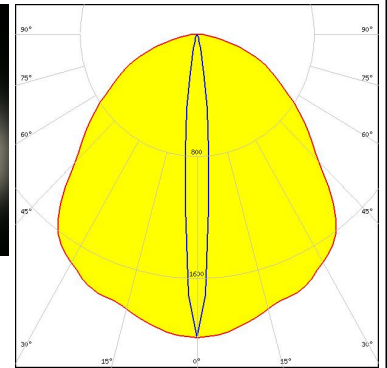

CREE LED

LED XP-G
 FWHM / FWTM 14.0 + 112.0°
 Efficiency 94 %
 LEDs/each optic 1
 Light colour White
 Required components:

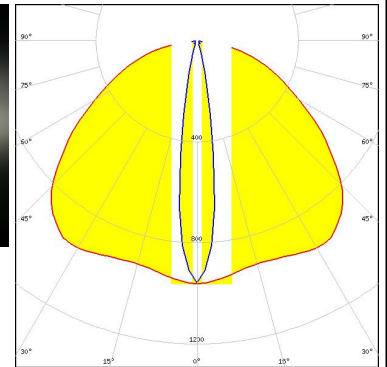
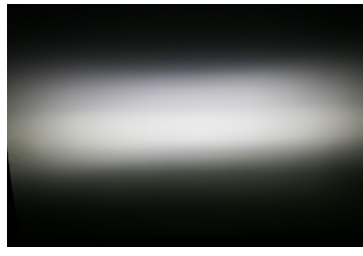

LUMILEDS

LED LUXEON Rebel
 FWHM / FWTM 11.0 + 93.0°
 Efficiency 94 %
 LEDs/each optic 1
 Light colour White
 Required components:

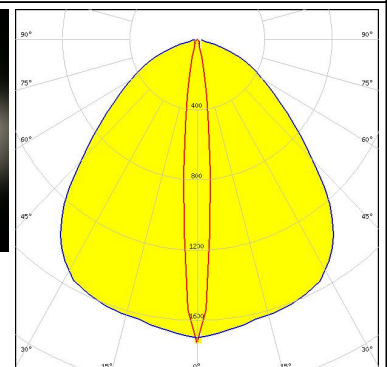

OPTICAL RESULTS (MEASURED):

LUMILEDS

LED LUXEON Rebel ES
FWHM / FWTM 12.0 + 104.0° / 35.0 + 154.0°
Efficiency 94 %
Peak intensity 1.4 cd/lm
LEDs/each optic 1
Light colour White
Required components:

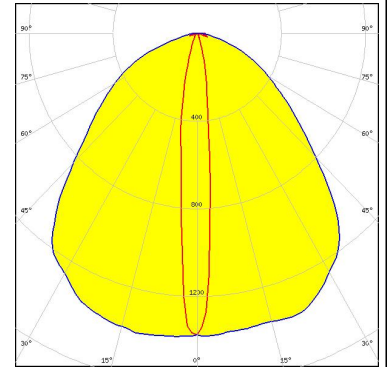

NICHIA

LED NCSxx19A
FWHM / FWTM 9.0 + 88.0°
Efficiency 94 %
LEDs/each optic 1
Light colour White
Required components:

NICHIA

LED NVSW219F
FWHM / FWTM 16.0 + 111.0° / 29.0 + 151.0°
Efficiency 94 %
Peak intensity 1.5 cd/lm
LEDs/each optic 1
Light colour White
Required components:

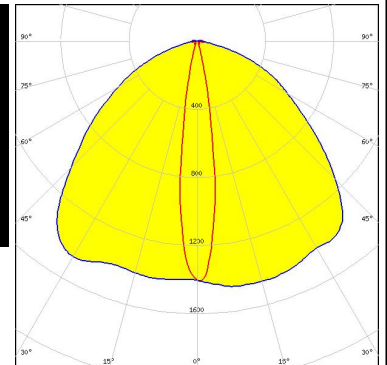
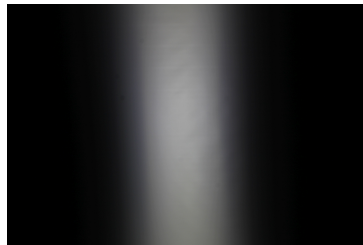

OSRAM Opto Semiconductors

LED OSLOM Square EC
FWHM / FWTM 13.0 + 107.0° / 23.0 + 158.0°
Efficiency 94 %
Peak intensity 1.8 cd/lm
LEDs/each optic 1
Light colour White
Required components:

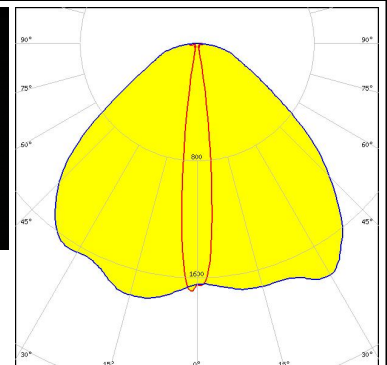
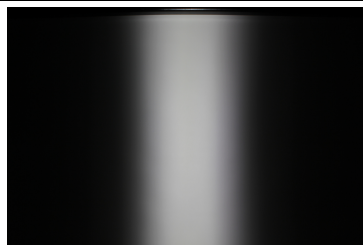

OPTICAL RESULTS (MEASURED):

OSRAM

Opto Semiconductors

LED OSLON SSL 150
 FWHM / FWTM 9.0 + 117.0°
 Efficiency 93 %
 Peak intensity 1.6 cd/lm
 LEDs/each optic 1
 Light colour White
 Required components:

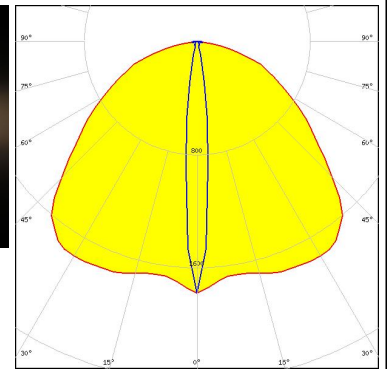

OSRAM

Opto Semiconductors

LED OSLON SSL 80
 FWHM / FWTM 9.0 + 88.0°
 Efficiency 94 %
 LEDs/each optic 1
 Light colour White
 Required components:

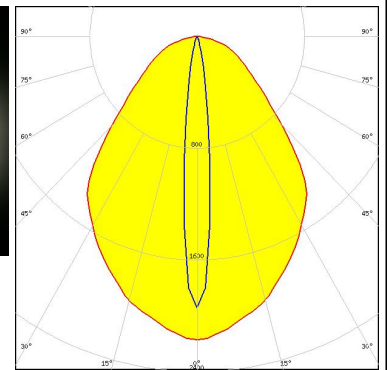
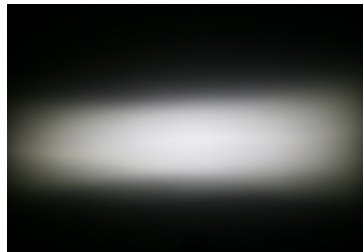

SAMSUNG

LED LH351Z
 FWHM / FWTM 14.0 + 106.0° / 24.0 + 134.0°
 Efficiency 94 %
 Peak intensity 1.9 cd/lm
 LEDs/each optic 1
 Light colour White
 Required components:

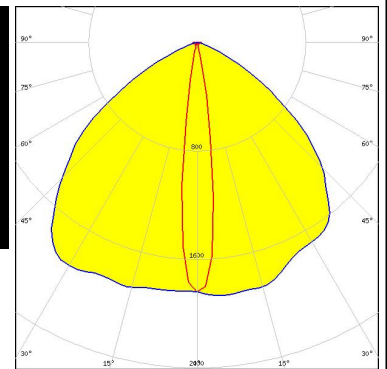
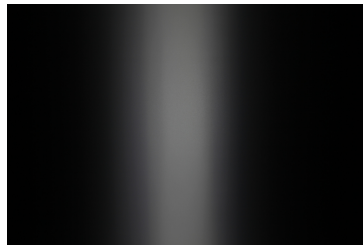

SEOUL SEMICONDUCTOR

LED Z5
 FWHM / FWTM 12.0 + 96.0°
 Efficiency %
 LEDs/each optic 1
 Light colour White
 Required components:

OPTICAL RESULTS (MEASURED):

SHARP

LED	Double Dome (GM2BB)
FWHM / FWTM	11.0 + 104.0°
Efficiency	%
LEDs/each optic	1
Light colour	White
Required components:	



OPTICAL RESULTS (SIMULATED):



LED MHB-A/B
FWHM / FWTM 26.0 + 100.0° / 48.0 + 150.0°
Efficiency 94 %
Peak intensity 1 cd/lm
LEDs/each optic 1
Light colour White
Required components:

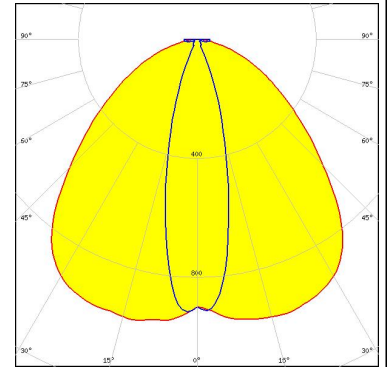

LED XHP50.3 HD
FWHM / FWTM 104.0 + 26.0° / 151.0 + 112.0°
Efficiency 95 %
Peak intensity 1 cd/lm
LEDs/each optic 1
Light colour White
Required components:

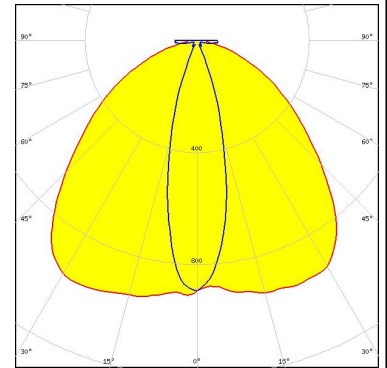

LED XP-E2
FWHM / FWTM 18.0 + 108.0° / 32.0 + 155.0°
Efficiency 94 %
Peak intensity 1.6 cd/lm
LEDs/each optic 1
Light colour White
Required components:



LED XP-G2
FWHM / FWTM 110.0 + 30.0° / 151.0 + 41.0°
Efficiency 96 %
Peak intensity 1 cd/lm
LEDs/each optic 1
Light colour White
Required components:

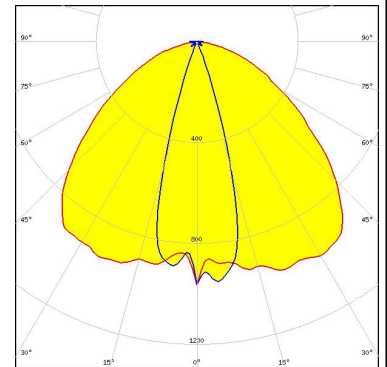

OPTICAL RESULTS (SIMULATED):



LED XP-G2 HE
FWHM / FWTM 16.0 + 99.0° / 29.0 + 150.0°
Efficiency 95 %
Peak intensity 15.2 cd/lm
LEDs/each optic 1
Light colour White
Required components:



LED XP-G3
FWHM / FWTM 99.0 + 14.0° / 154.0 + 28.0°
Efficiency 96 %
Peak intensity 1.6 cd/lm
LEDs/each optic 1
Light colour White
Required components:

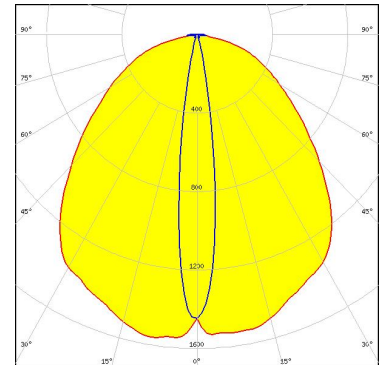

LED Duris S8
FWHM / FWTM 19.0 + 97.0° / 37.0 + 148.0°
Efficiency 94 %
Peak intensity 1.2 cd/lm
LEDs/each optic 1
Light colour White
Required components:

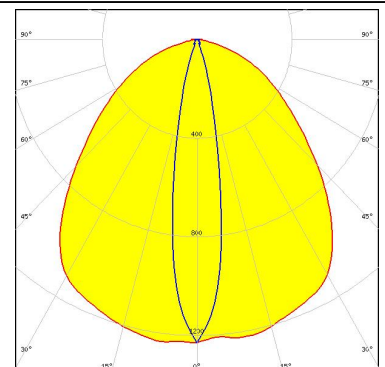

LED OSLOM Signal
FWHM / FWTM 8.0 + 80.0° / 18.0 + 149.0°
Efficiency 97 %
Peak intensity 2.8 cd/lm
LEDs/each optic 1
Light colour White
Required components:

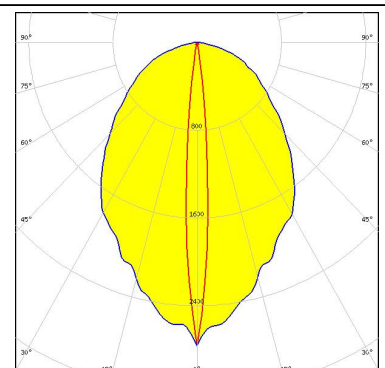

OPTICAL RESULTS (SIMULATED):

OSRAM
Opto Semiconductors

LED OSLON Signal
FWHM / FWTM 9.0 + 82.0° / 18.0 + 150.0°
Efficiency 97 %
Peak intensity 2.6 cd/lm
LEDs/each optic 1
Light colour White
Required components:

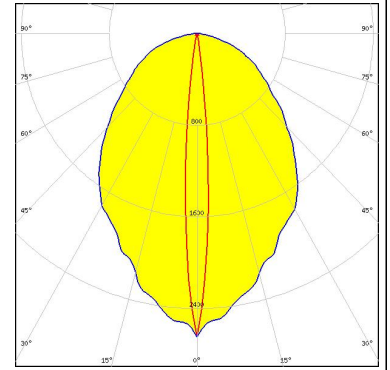

OSRAM
Opto Semiconductors

LED OSLON Signal
FWHM / FWTM 8.0 + 80.0° / 18.0 + 149.0°
Efficiency 97 %
Peak intensity 2.8 cd/lm
LEDs/each optic 1
Light colour White
Required components:

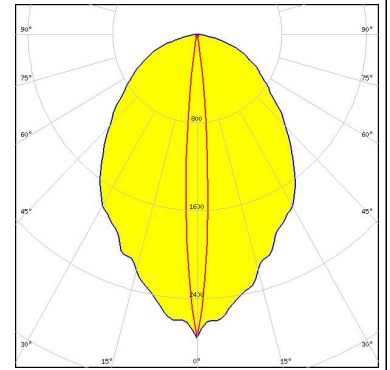

GENERAL INFORMATION:

NOTE: The typical beam angle will be changed by different color, chip size and chip position tolerance. The typical total beam angle is the full angle measured where the luminous intensity is half of the peak value.

MATERIALS:

As part of our continuous research and improvement processes, and to ensure the best possible quality and availability of our products, LEDiL reserves the right to change material grades without notice.

PRODUCT DATA USER AGREEMENT AND DISCLAIMER:

The measured data in the provided downloadable LEDiL Product Datasheets and Mechanical 2D-Drawings is rounded and provided as reference for planning. LEDiL Oy's optical specifications have been verified by conducting performance testing of the products in accordance with the company's quality system. The reported data are averaged results of multiple measurements with typical variation. LEDiL Oy reserves the right to without prior notification make changes and improvements to its products.

LEDiL Oy assumes neither warranty, nor guarantee nor any other liability of any kind for the contents and correctness of the provided data. The provided data has been generated with highest diligence but the provided data may in reality not represent the complete possible variation range of all intrinsic parameters. Therefore, in certain cases a deviation from the provided data could occur.

LEDiL Oy reserves the right to undertake technical changes of its products without further notification which could lead to changes in the provided data. LEDiL Oy assumes no liability of any kind for the possible deviation from any provided data or any other damage resulting from the usage of the provided data.

The user agrees to this disclaimer and user agreement with the download or usage of the provided files.

LEDiL Oy

Joensuunkatu 13
FI-24240 SALO
Finland

LEDiL Inc.

228 West Page Street
Suite D
Sycamore IL 60178
USA

Ledil Optics Technology (Shenzhen) Co., Ltd.

405 , Block B
Casic Motor Building
Shenzhen 518057
P.R.CHINA

Local sales and technical support

[www.ledil.com/
where_to_buy](http://www.ledil.com/where_to_buy)

Shipping locations

Salo, Finland
Hong Kong, China

Distribution Partners

[www.ledil.com/
where_to_buy](http://www.ledil.com/where_to_buy)