

DUAL N-Channel Enhancement Mode Power MOSFET

Description

The GT090N06D52 uses advanced trench technology to provide excellent $R_{DS(ON)}$, low gate charge. It can be used in a wide variety of applications.

General Features

- V_{DS} 60V
- I_D (at $V_{GS} = 10V$) 40A
- $R_{DS(ON)}$ (at $V_{GS} = 10V$) < 14m Ω
- $R_{DS(ON)}$ (at $V_{GS} = 4.5V$) < 18m Ω
- 100% Avalanche Tested
- RoHS Compliant

Application

- Power switch
- DC/DC converters

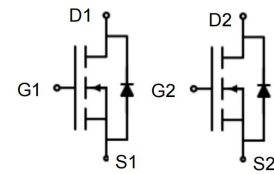

Schematic diagram

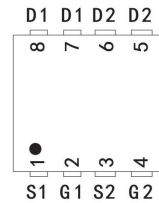

pin assignment

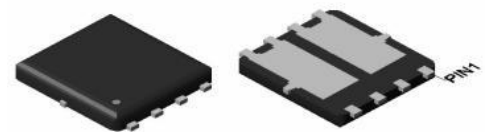

DFN5X6 Dual

Ordering Information

Device	Package	Marking	Packaging
GT090N06D52	DFN5X6 Dual	GT090N06	5000pcs/Reel

Absolute Maximum Ratings $T_C = 25^\circ\text{C}$, unless otherwise noted

Parameter	Symbol	Value	Unit
Drain-Source Voltage	V_{DS}	60	V
Continuous Drain Current	I_D	40	A
Pulsed Drain Current (note1)	I_{DM}	160	A
Gate-Source Voltage	V_{GS}	± 20	V
Power Dissipation	P_D	62	W
Single pulse avalanche energy (note2)	E_{AS}	20	mJ
Operating Junction and Storage Temperature Range	T_J, T_{stg}	-55 To 150	$^\circ\text{C}$

Thermal Resistance

Parameter	Symbol	Value	Unit
Thermal Resistance, Junction-to-Ambient	R_{thJA}	65	$^\circ\text{C/W}$
Maximum Junction-to-Case	R_{thJC}	2	$^\circ\text{C/W}$

Specifications $T_J = 25^\circ\text{C}$, unless otherwise noted						
Parameter	Symbol	Test Conditions	Value			Unit
			Min.	Typ.	Max.	
Static Parameters						
Drain-Source Breakdown Voltage	$V_{(BR)DSS}$	$V_{GS} = 0V, I_D = 250\mu A$	60	--	--	V
Zero Gate Voltage Drain Current	I_{DSS}	$V_{DS} = 60V, V_{GS} = 0V$	--	--	1	μA
Gate-Source Leakage	I_{GSS}	$V_{GS} = \pm 20V$	--	--	± 100	nA
Gate-Source Threshold Voltage	$V_{GS(th)}$	$V_{DS} = V_{GS}, I_D = 250\mu A$	1	1.4	2.5	V
Drain-Source On-Resistance	$R_{DS(on)}$	$V_{GS} = 10V, I_D = 14A$	--	9	14	m Ω
		$V_{GS} = 4.5V, I_D = 10A$	--	12	18	
Forward Transconductance	g_{FS}	$V_{GS} = 5V, I_D = 14A$	--	24	--	S
Dynamic Parameters						
Input Capacitance	C_{iss}	$V_{GS} = 0V,$ $V_{DS} = 30V,$ $f = 1.0\text{MHz}$	--	1011	--	pF
Output Capacitance	C_{oss}		--	304	--	
Reverse Transfer Capacitance	C_{rss}		--	25	--	
Total Gate Charge	Q_g	$V_{DD} = 30V,$ $I_D = 14A,$ $V_{GS} = 10V$	--	24	--	nC
Gate-Source Charge	Q_{gs}		--	5	--	
Gate-Drain Charge	Q_{gd}		--	3	--	
Turn-on Delay Time	$t_{d(on)}$	$V_{DD} = 30V,$ $I_D = 14A,$ $R_G = 10\Omega$	--	9	--	ns
Turn-on Rise Time	t_r		--	4	--	
Turn-off Delay Time	$t_{d(off)}$		--	29	--	
Turn-off Fall Time	t_f		--	4	--	
Drain-Source Body Diode Characteristics						
Continuous Body Diode Current	I_S	$T_C = 25^\circ\text{C}$	--	--	40	A
Body Diode Voltage	V_{SD}	$T_J = 25^\circ\text{C}, I_{SD} = 14A, V_{GS} = 0V$	--	--	1.2	V
Reverse Recovery Charge	Q_{rr}	$I_F = 14A, V_{GS} = 0V$ $di/dt = 500A/\mu s$	--	65	--	nC
Reverse Recovery Time	T_{rr}		--	19	--	ns

Notes

1. Repetitive Rating: Pulse width limited by maximum junction temperature
2. EAS condition : $T_J = 25^\circ\text{C}, V_{DD} = 50V, V_{GS} = 10V, L = 0.5\text{mH}, R_G = 25\Omega$
3. Identical low side and high side switch with identical R_G

Gate Charge Test Circuit



Switch Time Test Circuit



EAS Test Circuit



Typical Characteristics $T_J = 25^\circ\text{C}$, unless otherwise noted

Figure 1. Output Characteristics

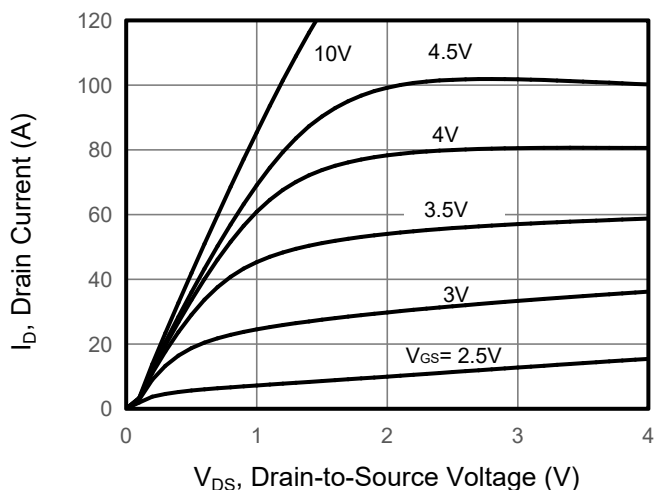

Figure 2. Transfer Characteristics

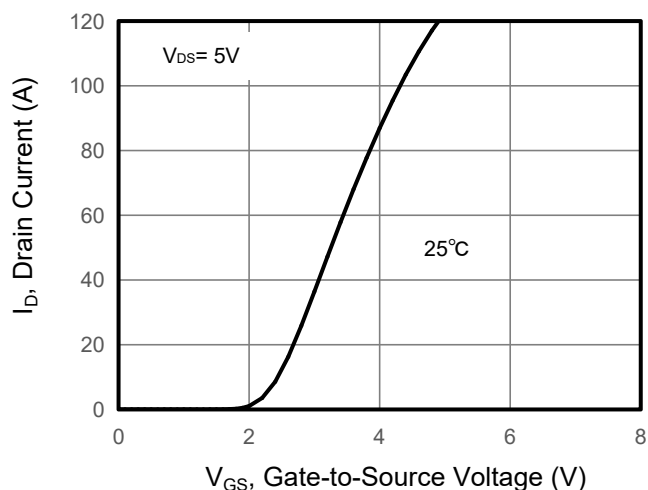

Figure 3. Drain Source On Resistance

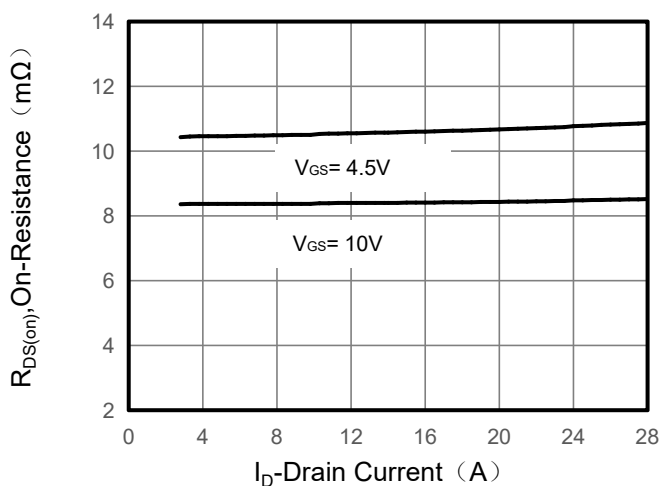

Figure 4. Gate Charge

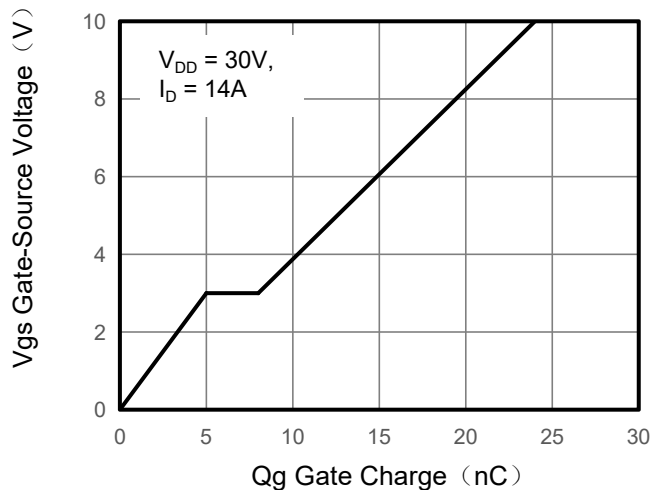

Figure 5. Capacitance

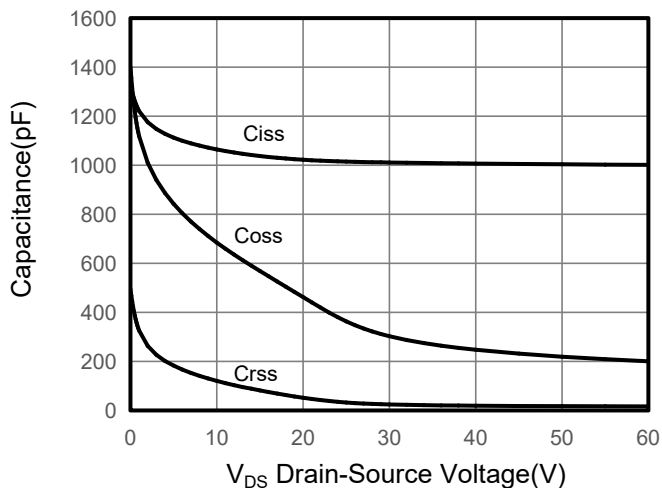
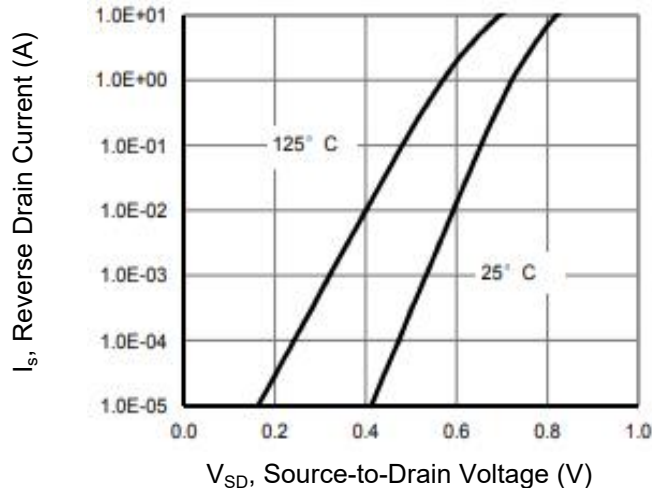

Figure 6. Source-Drain Diode Forward



Typical Characteristics $T_J = 25^\circ\text{C}$, unless otherwise noted

Figure 7. Drain-Source On-Resistance

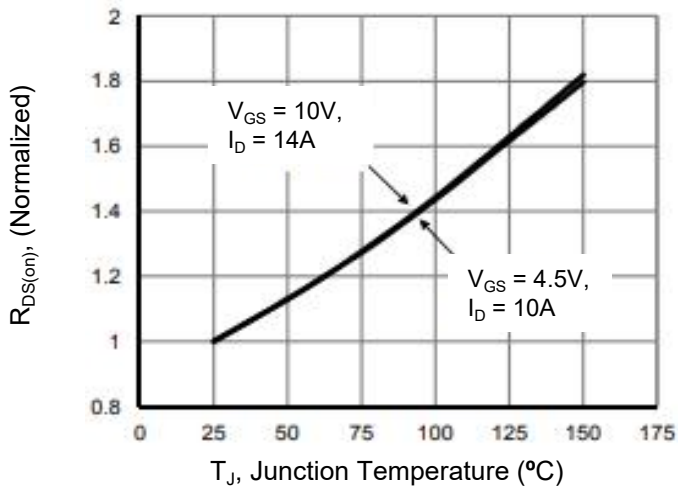

Figure 8. Safe Operation Area

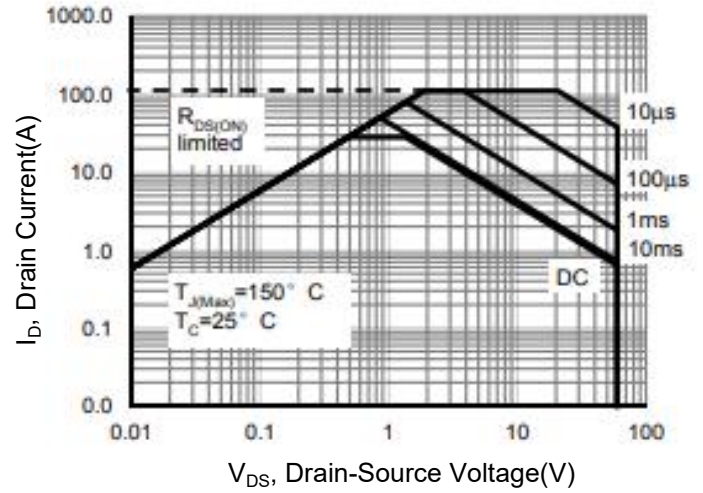
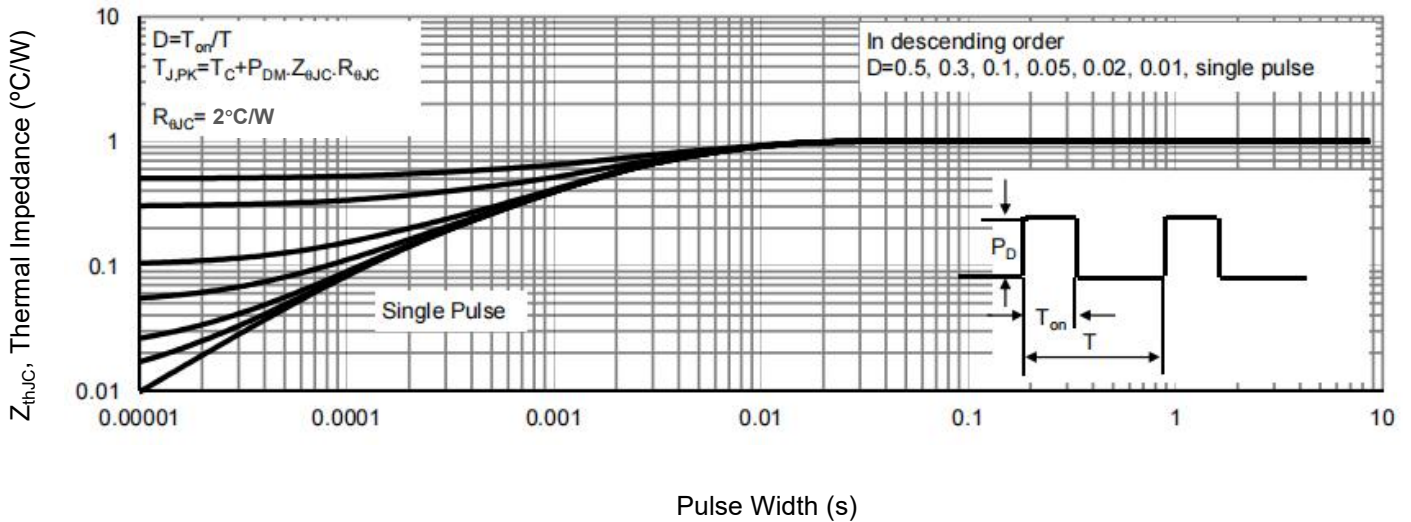
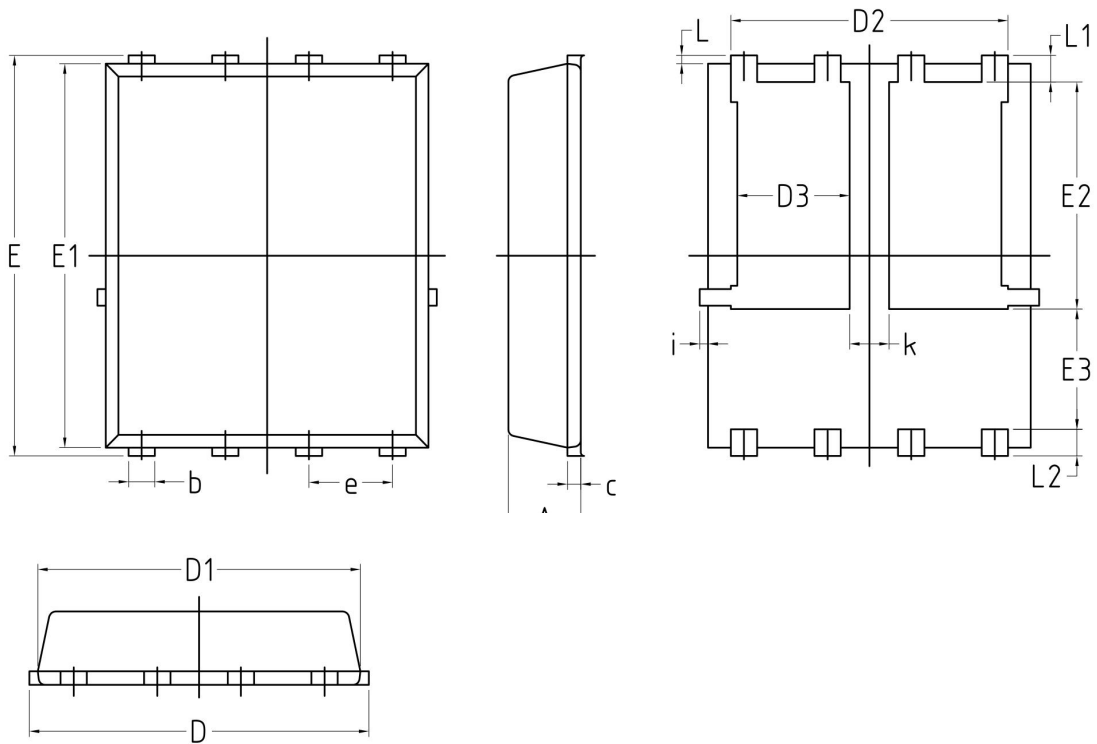

Figure 9. Normalized Maximum Transient Thermal Impedance



DFN5X6-8L Dual Package Information



S Y M B O L	COMMON			
	MM		INCH	
	MIN.	MAX.	MIN.	MAX.
A	1.03	1.17	0.0406	0.0461
b	0.34	0.48	0.0134	0.0189
c	0.203 BSC		0.0080 BSC	
D	4.80	5.40	0.1890	0.2126
D1	4.80	5.00	0.1890	0.1969
D2	4.11	4.31	0.1620	0.1700
D3	1.60	1.80	0.0629	0.0708
E	5.95	6.15	0.2343	0.2421
E1	5.65	5.85	0.2224	0.2303
E2	3.30	3.50	0.1300	0.1378
E3	1.70	/	0.0630	/
e	1.27 BSC		0.05 BSC	
L	0.05	0.25	0.0019	0.0098
L1	0.38	0.50	0.0150	0.0197
L2	0.38	0.50	0.0150	0.0197
i	/	0.18	/	0.0070
k	0.5	0.7	0.0197	0.0276