

Background suppression sensor

VT18-8-H-120-M/40a/65b/118/128



- Adjustable background suppression
- Array control panel with highly visible LED display
- Flashing power on LED in case of short-circuit
- Multiple device installation possible, no mutual interference (no cross-talk)
- Not sensitive to ambient light, even with switched energy saving lamps
- Protection class II

Triangulation sensor with background suppression, M18 threaded housing design, metal housing, front optical face, 120 mm detection range, red light, light/dark on, DC version, push-pull output, M12 plug



Dimensions

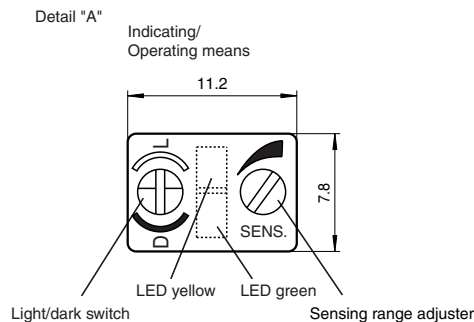
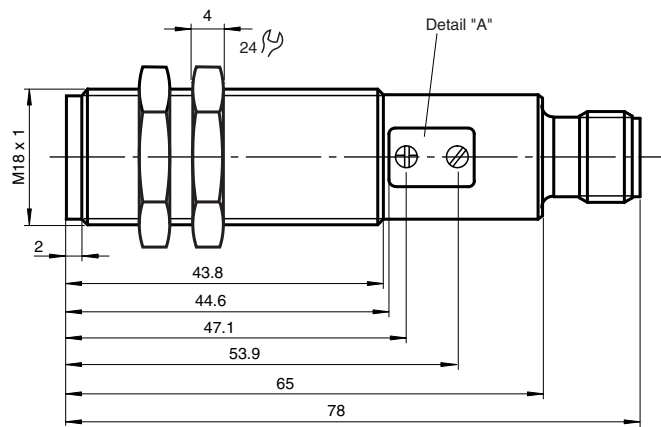

Unit connector



Release date: 2022-08-08 Date of issue: 2022-08-08 Filename: 800191_eng.pdf

Refer to "General Notes Relating to Pepperl+Fuchs Product Information".

Pepperl+Fuchs Group
www.pepperl-fuchs.com

USA: +1 330 486 0001
fa-info@us.pepperl-fuchs.com

Germany: +49 621 776 1111
fa-info@de.pepperl-fuchs.com

Singapore: +65 6779 9091
fa-info@sg.pepperl-fuchs.com

PEPPERL+FUCHS

Technical Data

General specifications		
Detection range		20 ... 120 mm , adjustable
Detection range min.		20 ... 40 mm
Detection range max.		20 ... 120 mm
Light source		LED
Light type		modulated visible red light , 660 nm
Black-white difference (6 %/90 %)		< 10 % at a distance of 120 mm
Diameter of the light spot		approx. 6 mm at a distance of 120 mm
Optical face		frontal
Ambient light limit		30000 Lux
Functional safety related parameters		
MTTF _d		860 a
Mission Time (T _M)		20 a
Diagnostic Coverage (DC)		0 %
Indicators/operating means		
Operation indicator		LED green, flashes in case of short-circuit
Function indicator		LED yellow, lights up with receiver lit
Control elements		Sensing range adjuster, light-on/dark-on changeover switch
Electrical specifications		
Operating voltage	U _B	10 ... 30 V DC
Ripple		10 %
No-load supply current	I ₀	< 35 mA
Protection class		II , rated voltage ≤ 50 V AC with pollution degree 1-2 according to IEC 60664-1
Output		
Switching type		light/dark on, switchable
Signal output		Push-pull (4 in 1) output short-circuit protected overvoltage protected
Switching voltage		30 V DC
Switching current		max. 200 mA
Switching frequency	f	500 Hz
Response time		1 ms
Conformity		
Product standard		EN 60947-5-2
Approvals and certificates		
CE conformity		yes
EAC conformity		TR CU 020/2011
UL approval		cULus Listed, Type 1 enclosure
CCC approval		CCC approval / marking not required for products rated ≤36 V
Ambient conditions		
Ambient temperature		-25 ... 70 °C (-13 ... 158 °F)
Storage temperature		-30 ... 70 °C (-22 ... 158 °F)
Mechanical specifications		
Degree of protection		IP67
Connection		4-pin, M12 x 1 connector
Material		
Housing		brass, nickel-plated
Optical face		PMMA
Mass		60 g

Connection Assignment

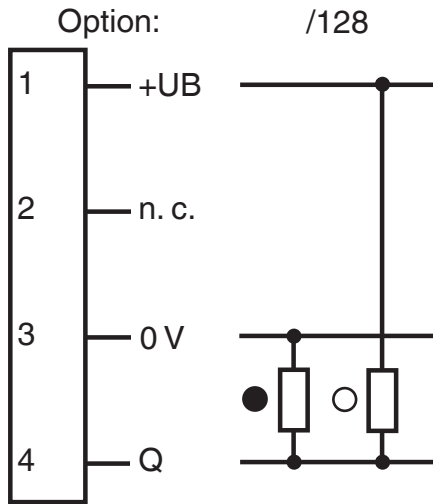

○ = Light on
● = Dark on

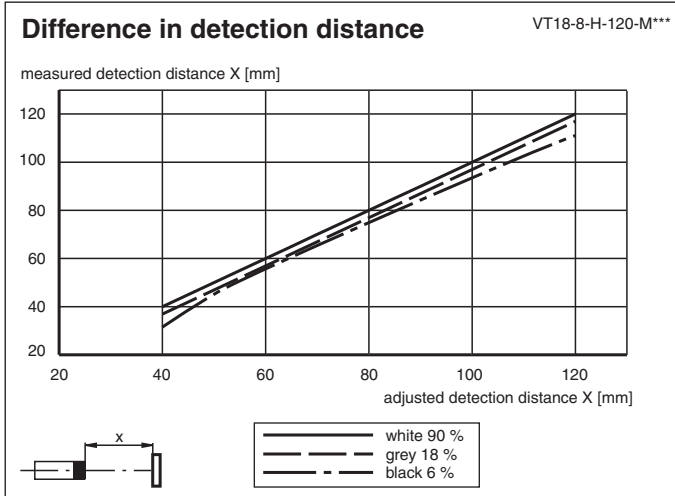
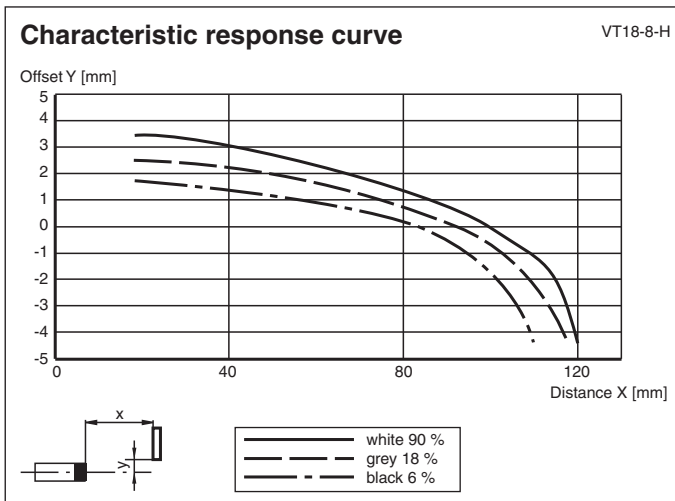

Characteristic Curve



Release date: 2022-08-08 Date of issue: 2022-08-08 Filename: 800191_eng.pdf

Refer to "General Notes Relating to Pepperl+Fuchs Product Information".

Accessories

	BF 18	Mounting flange, 18 mm
	OMH-VL18	Mounting Bracket with swivel nut