

**Data sheet | Item number: 2210-1301**

3-conductor through terminal block; with push-button; 10 mm<sup>2</sup>; with test port; side and center marking; for DIN-rail 35 x 15 and 35 x 7.5; Push-in CAGE CLAMP®; 10,00 mm<sup>2</sup>; gray

[www.wago.com/2210-1301](http://www.wago.com/2210-1301)

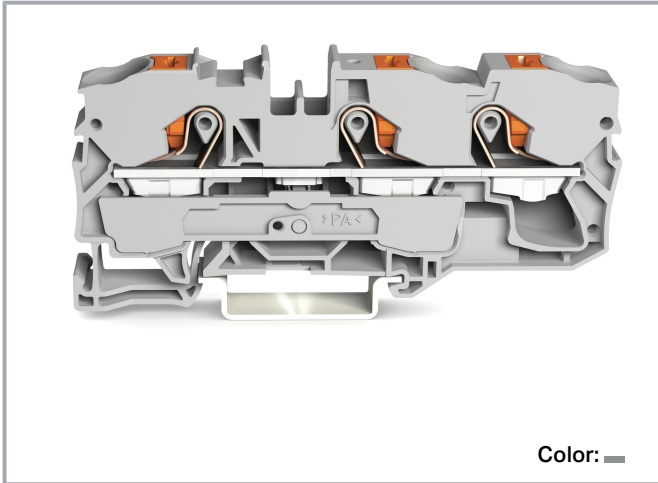

Color: ■

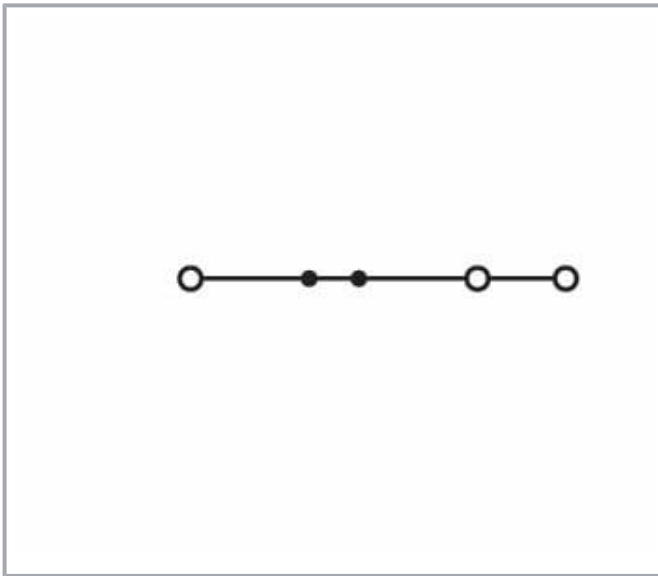
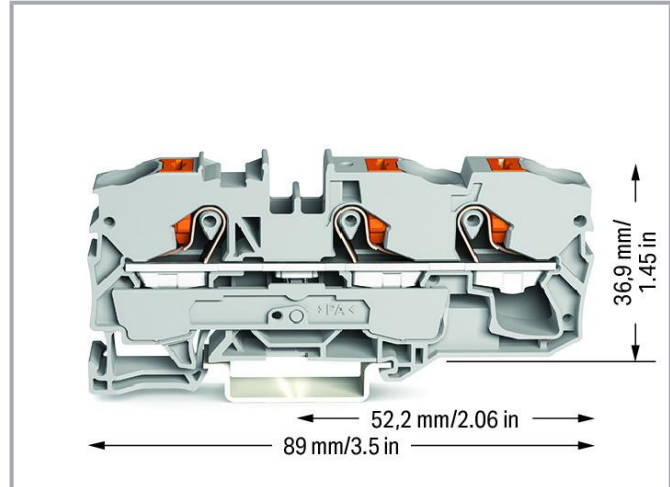

**Data**

**Electrical data**

**Ratings per IEC/EN**

Ratings per	IEC/EN 60947-7-1
Nominal voltage (III/3)	800 V

Subject to changes. Please also observe the further product documentation!

WAGO GmbH & Co. KG  
Hansastr. 27  
32423 Minden  
Phone: +49571 887-0 | Fax: +49571 887-169  
Email: [info.de@wago.com](mailto:info.de@wago.com) | Web: [www.wago.com](http://www.wago.com)

Do you have any questions about our products?  
We are always happy to take your call at +49 (571) 887-44222.



Rated impulse voltage (III/3)	8 kV
Rated current	57 A
Current at conductor cross-section (max.) mm <sup>2</sup>	76 A
Legend (ratings)	(III / 3) $\triangleq$ Overvoltage category III / Pollution degree 3

### Ratings per UL 1059

Approvals per	UL 1059
Rated voltage UL (Use Group B)	600 V
Rated current UL (Use Group B)	65 A
Rated voltage UL (Use Group C)	600 V
Rated current UL (Use Group C)	65 A

### Ratings per CSA

Approvals per	CSA 22.2 No 158
Rated voltage CSA (Use Group B)	600 V
Rated current CSA (Use Group B)	64 A
Rated voltage CSA (Use Group C)	600 V
Rated current CSA (Use Group C)	64 A

### Ex information

Reference hazardous areas	See "Downloads – Documentation – Additional Information: Technical Section; Technical Explications"
Ratings per	ATEX: PTB 18 ATEX 1008 U / IECEx: PTB 18.0015U (Ex eb IIC Gb)
Rated voltage EN (Ex e II)	550 V
Rated current (Ex e II)	54 A
Rated current (Ex e II) with jumper	50 A

### Power loss

Power loss, per pole (potential)	1.819 W
Rated current $I_N$ for specified power loss	57 A
Resistance value for specified, current-dependent power loss	0.001 $\Omega$

### Connection data

Connection points	3
Total number of potentials	1
Number of levels	1

Subject to changes. Please also observe the further product documentation!



Number of jumper slots	2
------------------------	---

### Connection 1

Connection technology	Push-in CAGE CLAMP®
Actuation type	Push-button
Connectable conductor materials	Copper
Nominal cross-section	10 mm <sup>2</sup>
Solid conductor	0.5 ... 16 mm <sup>2</sup> / 20 ... 6 AWG
Solid conductor; push-in termination	2.5 ... 16 mm <sup>2</sup> / 14 ... 6 AWG
Fine-stranded conductor	0.5 ... 16 mm <sup>2</sup> / 20 ... 6 AWG
Fine-stranded conductor; with insulated ferrule	0.5 ... 10 mm <sup>2</sup> / 20 ... 8 AWG
Fine-stranded conductor; with ferrule; push-in termination	4 ... 10 mm <sup>2</sup> / 12 ... 8 AWG
Note (conductor cross-section)	Depending on the conductor characteristic, a conductor with a smaller cross-section can also be inserted via push-in termination.
Strip length	17 ... 19 mm / 0.67 ... 0.75 inches
Wiring direction	Front-entry wiring

### Physical data

Width	10 mm / 0.394 inches
Height	89 mm / 3.504 inches
Depth from upper-edge of DIN-rail	36.9 mm / 1.453 inches

### Mechanical Data

Mounting type	DIN-35 rail
Marking level	Center/side marking

### Material Data

Note (material data)	Information on material specifications can be found here
Color	gray
Material group	I
Insulation material	Polyamide (PA66)
Flammability class per UL94	V0
Fire load	0.532 MJ
Weight	25.5 g

Subject to changes. Please also observe the further product documentation!

## Environmental requirements

Processing temperature	-35 ... +85 °C
Continuous operating temperature	-60 ... +105 °C

## Commercial data

eCl@ss 10.0	27-14-11-20
eCl@ss 9.0	27-14-11-20
ETIM 8.0	EC000897
ETIM 7.0	EC000897
PU (SPU)	25 pcs
Packaging type	box
Country of origin	DE
GTIN	4055143736114
Customs tariff number	85369010000

## Environmental Product Compliance

RoHS Compliance Status	Compliant, No Exemption
------------------------	-------------------------

## Approvals / Certificates



### General approvals

Logo	Approval	Additional Approval Text	Certificate name
	CCA DEKRA Certification B.V.	EN 60947	NTR NL 7879
	CCC CNEX	GB/T 3836.3	2020312313000173 (Ex eb IIC Gb, Ex eb I Mb)
	CSA DEKRA Certification B.V.	C22.2	70175033
	KEMA/KEUR DEKRA Certification B.V.	EN 60947	71-119265
	UL Underwriters Laboratories Inc.	UL 1059	E45172





Subject to changes. Please also observe the further product documentation!



## Declarations of conformity and manufacturer's declarations

Logo	Approval	Additional Approval Text	Certificate name
	EU-Declaration of Conformity WAGO GmbH & Co. KG	-	-
	UK-Declaration of Conformity WAGO GmbH & Co. KG	-	-

## Approvals for marine applications

Logo	Approval	Additional Approval Text	Certificate name
	ABS American Bureau of Shipping	-	19- HG1866350- PDA
	BV Bureau Veritas S.A.	IEC 60947	58186/A0 BV
	DNV GL Det Norske Veritas, Germanischer Lloyd	-	TAE00003JT
	LR Lloyds Register	-	19/20050

## Approvals for hazardous areas





Logo	Approval	Additional Approval Text	Certificate name
	ATEX Physikalisch Technische Bundesanstalt	IEC 60079-0	PTB 18 ATEX 1008 U (II 2 G Ex eb IIC Gb bzw. I M 2 Ex eb I Mb)
	ATEX UL International Demko A/S	UL 60079	E185892 (AEx eb IIC resp. Ex eb IIC)

Subject to changes. Please also observe the further product documentation!

WAGO GmbH & Co. KG  
Hansastr. 27  
32423 Minden  
Phone: +49571 887-0 | Fax: +49571 887-169  
Email: [info.de@wago.com](mailto:info.de@wago.com) | Web: [www.wago.com](http://www.wago.com)

Do you have any questions about our products?  
We are always happy to take your call at +49 (571) 887-44222.



# AEx

	<b>CCC</b> CNEX	GB/T 3836.3	2020312313000173 (Ex eb IIC Gb, Ex eb I Mb)
	<b>EAC</b> Brjansker Zertifizierungsstelle	TP TC 012/2011	RU C-DE.AM02.B. 00127/19 (Ex e IIC Gb U)
	<b>IECEX</b> Physikalisch Technische Bundesanstalt	IEC 60079	IECEX PTB 18.0015U (Ex eb IIC Gb and Ex eb I Mb)
	<b>INMETRO</b> TÜV Rheinland do Brasil Ltda.	IEC 60079	TÜV 19.0821 U

## Required accessories

### End plate

End plate

	<b>Item no.: 2010-1391</b> End and intermediate plate; 1 mm thick; gray	<a href="http://www.wago.com/2010-1391">www.wago.com/2010-1391</a>
	<b>Item no.: 2010-1392</b> End and intermediate plate; 1 mm thick; orange	<a href="http://www.wago.com/2010-1392">www.wago.com/2010-1392</a>
	<b>Item no.: 209-191</b> Separator for Ex e/Ex i applications; 3 mm thick; 120 mm wide; orange	<a href="http://www.wago.com/209-191">www.wago.com/209-191</a>

## Optional accessories

### Tool

Operating tool

	<b>Item no.: 210-721</b> Operating tool; Blade: 5.5 x 0.8 mm; with a partially insulated shaft; multicoloured	<a href="http://www.wago.com/210-721">www.wago.com/210-721</a>
--	--	--

### Mounting

Cover carrier

Subject to changes. Please also observe the further product documentation!



**Item no.: 709-169**  
Cover carrier; Type 3; gray

[www.wago.com/709-169](http://www.wago.com/709-169)

Cover



**Item no.: 709-156**  
Cover; Type 3; suitable for cover carrier, type 3; 1 m long; transparent

[www.wago.com/709-156](http://www.wago.com/709-156)

Jumpers

Jumper



**Item no.: 2010-402**  
Jumper; 2-way; insulated; light gray

[www.wago.com/2010-402](http://www.wago.com/2010-402)



**Item no.: 2010-404**  
Jumper; 4-way; insulated; light gray

[www.wago.com/2010-404](http://www.wago.com/2010-404)



**Item no.: 2010-403**  
Jumper; 3-way; insulated; light gray

[www.wago.com/2010-403](http://www.wago.com/2010-403)



**Item no.: 2010-405/011-000**  
Star point jumper; 3-way; insulated; light gray

[www.wago.com/2010-405/011-000](http://www.wago.com/2010-405/011-000)



**Item no.: 2010-405**  
Jumper; 5-way; insulated; light gray

[www.wago.com/2010-405](http://www.wago.com/2010-405)



**Item no.: 2010-435**  
Jumper; from 1 to 5; insulated; light gray

[www.wago.com/2010-435](http://www.wago.com/2010-435)



**Item no.: 2010-433**  
Jumper; from 1 to 3; insulated; light gray

[www.wago.com/2010-433](http://www.wago.com/2010-433)



**Item no.: 2010-434**  
Jumper; from 1 to 4; insulated; light gray

[www.wago.com/2010-434](http://www.wago.com/2010-434)



**Item no.: 2016-499**  
Step-down jumper; from 2016/2010 to 2010/2006/2004/2002 series; from 2216/2210 to 2210/2206 /2204/2202 series; insulated; light gray

[www.wago.com/2016-499](http://www.wago.com/2016-499)



**Item no.: 285-430**  
Step-down jumper; from 285 (35mm<sup>2</sup>) to 2016/2010 series; insulated; gray

[www.wago.com/285-430](http://www.wago.com/285-430)

Testing and measuring

Testing accessories



**Item no.: 2009-174**  
Test plug adapter; for 4 mm Ø test plugs; for testing TOPJOB®S rail-mounted terminal blocks; gray















[www.wago.com/2009-174](http://www.wago.com/2009-174)

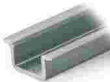

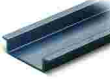
**Item no.: 2009-182**  
Testing tap; for max. 2.5 mm<sup>2</sup>; tool-free connection for individual test wires 0.08 - 2.5 mm; gray

[www.wago.com/2009-182](http://www.wago.com/2009-182)

Subject to changes. Please also observe the further product documentation!

	<b>Item no.: 2010-511</b> Modular TOPJOB®S connector; modular; for jumper contact slot; 1-pole; 4,00 mm <sup>2</sup> ; gray	<a href="http://www.wago.com/2010-511">www.wago.com/2010-511</a>
	<b>Item no.: 2010-549</b> Spacer module; modular; e.g., for bridging commoned terminal blocks; gray	<a href="http://www.wago.com/2010-549">www.wago.com/2010-549</a>
<b>Cover</b>		
Cover		
	<b>Item no.: 2010-100</b> Finger guard; touchproof cover protects unused conductor entries; yellow	<a href="http://www.wago.com/2010-100">www.wago.com/2010-100</a>
<b>Carrier rail</b>		
Mounting accessories		
	<b>Item no.: 210-197</b> Steel carrier rail; 35 x 15 mm; 1.5 mm thick; 2 m long; slotted; similar to EN 60715; silver-colored	<a href="http://www.wago.com/210-197">www.wago.com/210-197</a>
	<b>Item no.: 210-198</b> Copper carrier rail; 35 x 15 mm; 2.3 mm thick; 2 m long; unslotted; according to EN 60715; copper-colored	<a href="http://www.wago.com/210-198">www.wago.com/210-198</a>
	<b>Item no.: 210-113</b> Steel carrier rail; 35 x 7.5 mm; 1 mm thick; 2 m long; unslotted; according to EN 60715; silver-colored	<a href="http://www.wago.com/210-113">www.wago.com/210-113</a>
	<b>Item no.: 210-118</b> Steel carrier rail; 35 x 15 mm; 2.3 mm thick; 2 m long; unslotted; according to EN 60715; silver-colored	<a href="http://www.wago.com/210-118">www.wago.com/210-118</a>
	<b>Item no.: 210-114</b> Steel carrier rail; 35 x 15 mm; 1.5 mm thick; 2 m long; unslotted; similar to EN 60715; silver-colored	<a href="http://www.wago.com/210-114">www.wago.com/210-114</a>
	<b>Item no.: 210-196</b> Aluminum carrier rail; 35 x 8.2 mm; 1.6 mm thick; 2 m long; unslotted; similar to EN 60715; silver-colored	<a href="http://www.wago.com/210-196">www.wago.com/210-196</a>
<b>Ferrule</b>		
Ferrule		
	<b>Item no.: 216-284</b> Ferrule; Sleeve for 1.5 mm <sup>2</sup> / AWG 16; insulated; electro-tin plated; electrolytic copper; gastight crimped; acc. to DIN 46228, Part 4/09.90; black	<a href="http://www.wago.com/216-284">www.wago.com/216-284</a>
	<b>Item no.: 216-286</b> Ferrule; Sleeve for 2.5 mm <sup>2</sup> / AWG 14; insulated; electro-tin plated; electrolytic copper; gastight crimped; acc. to DIN 46228, Part 4/09.90; blue	<a href="http://www.wago.com/216-286">www.wago.com/216-286</a>
	<b>Item no.: 216-287</b> Ferrule; Sleeve for 4 mm <sup>2</sup> / AWG 12; insulated; electro-tin plated; electrolytic copper; gastight crimped; acc. to DIN 46228, Part 4/09.90; gray	<a href="http://www.wago.com/216-287">www.wago.com/216-287</a>
	<b>Item no.: 216-288</b> Ferrule; Sleeve for 6 mm <sup>2</sup> / AWG 10; insulated; electro-tin plated; electrolytic copper; gastight crimped; acc. to DIN 46228, Part 4/09.90; yellow	<a href="http://www.wago.com/216-288">www.wago.com/216-288</a>
	<b>Item no.: 216-289</b>	

Subject to changes. Please also observe the further product documentation!



Ferrule; Sleeve for 10 mm<sup>2</sup> / AWG 8; insulated; electro-tin plated; electrolytic copper; gastight crimped; [www.wago.com/216-289](http://www.wago.com/216-289)  
acc. to DIN 46228, Part 4/09.90; red

### Marking accessories

#### Marking strip



**Item no.: 2009-110**

Marking strips; for Smart Printer; on reel; not stretchable; plain; snap-on type; white

[www.wago.com/2009-110](http://www.wago.com/2009-110)

#### Marker carrier



**Item no.: 2009-198**

Adaptor; gray

[www.wago.com/2009-198](http://www.wago.com/2009-198)

#### Marker



**Item no.: 2009-115/000-002**

WMB-Inline; for Smart Printer; 1500 pieces on roll; stretchable 5 - 5.2 mm; plain; snap-on type; yellow

[www.wago.com/2009-115/000-002](http://www.wago.com/2009-115/000-002)



**Item no.: 2009-115/000-007**

WMB-Inline; for Smart Printer; 1500 pieces on roll; stretchable 5 - 5.2 mm; plain; snap-on type; gray

[www.wago.com/2009-115/000-007](http://www.wago.com/2009-115/000-007)



**Item no.: 2009-115/000-017**

WMB-Inline; for Smart Printer; 1500 pieces on roll; stretchable 5 - 5.2 mm; plain; snap-on type; light green

[www.wago.com/2009-115/000-017](http://www.wago.com/2009-115/000-017)



**Item no.: 2009-115/000-023**

WMB-Inline; for Smart Printer; 1500 pieces on roll; stretchable 5 - 5.2 mm; plain; snap-on type; green

[www.wago.com/2009-115/000-023](http://www.wago.com/2009-115/000-023)



**Item no.: 2009-115/000-024**

WMB-Inline; for Smart Printer; 1500 pieces on roll; stretchable 5 - 5.2 mm; plain; snap-on type; violet

[www.wago.com/2009-115/000-024](http://www.wago.com/2009-115/000-024)



**Item no.: 2009-145/000-006**

Mini-WSB Inline; for Smart Printer; 1700 pieces on roll; stretchable 5 - 5.2 mm; plain; snap-on type; blue

[www.wago.com/2009-145/000-006](http://www.wago.com/2009-145/000-006)



**Item no.: 2009-145**

Mini-WSB Inline; for Smart Printer; 1700 pieces on roll; stretchable 5 - 5.2 mm; plain; snap-on type; white

[www.wago.com/2009-145](http://www.wago.com/2009-145)



**Item no.: 2009-145/000-002**

Mini-WSB Inline; for Smart Printer; 1700 pieces on roll; stretchable 5 - 5.2 mm; plain; snap-on type; yellow

[www.wago.com/2009-145/000-002](http://www.wago.com/2009-145/000-002)



**Item no.: 2009-145/000-007**

Mini-WSB Inline; for Smart Printer; 1700 pieces on roll; stretchable 5 - 5.2 mm; plain; snap-on type; gray

[www.wago.com/2009-145/000-007](http://www.wago.com/2009-145/000-007)

Subject to changes. Please also observe the further product documentation!

WAGO GmbH & Co. KG

Hansastr. 27













32423 Minden

Phone: +49571 887-0 | Fax: +49571 887-169

Email: [info.de@wago.com](mailto:info.de@wago.com) | Web: [www.wago.com](http://www.wago.com)

Do you have any questions about our products?

We are always happy to take your call at +49 (571) 887-44222.

	<p><b>Item no.: 2009-145/000-005</b>                  Mini-WSB Inline; for Smart Printer; 1700 pieces on roll; stretchable 5 - 5.2 mm; plain; snap-on type; red</p>	<p><a href="http://www.wago.com/2009-145/000-005">www.wago.com/2009-145/000-005</a></p>
	<p><b>Item no.: 2009-145/000-012</b>                  Mini-WSB Inline; for Smart Printer; 1700 pieces on roll; stretchable 5 - 5.2 mm; plain; snap-on type; orange</p>	<p><a href="http://www.wago.com/2009-145/000-012">www.wago.com/2009-145/000-012</a></p>
	<p><b>Item no.: 2009-145/000-023</b>                  Mini-WSB Inline; for Smart Printer; 1700 pieces on roll; stretchable 5 - 5.2 mm; plain; snap-on type; green</p>	<p><a href="http://www.wago.com/2009-145/000-023">www.wago.com/2009-145/000-023</a></p>
	<p><b>Item no.: 2009-145/000-024</b>                  Mini-WSB Inline; for Smart Printer; 1700 pieces on roll; stretchable 5 - 5.2 mm; plain; snap-on type; violet</p>	<p><a href="http://www.wago.com/2009-145/000-024">www.wago.com/2009-145/000-024</a></p>
	<p><b>Item no.: 2009-115</b>                  WMB-Inline; for Smart Printer; 1500 pieces on roll; stretchable 5 - 5.2 mm; plain; snap-on type; white</p>	<p><a href="http://www.wago.com/2009-115">www.wago.com/2009-115</a></p>
	<p><b>Item no.: 248-501/000-006</b>                  Mini-WSB marking card; as card; not stretchable; plain; snap-on type; blue</p>	<p><a href="http://www.wago.com/248-501/000-006">www.wago.com/248-501/000-006</a></p>
	<p><b>Item no.: 248-501/000-007</b>                  Mini-WSB marking card; as card; not stretchable; plain; snap-on type; gray</p>	<p><a href="http://www.wago.com/248-501/000-007">www.wago.com/248-501/000-007</a></p>
	<p><b>Item no.: 248-501/000-002</b>                  Mini-WSB marking card; as card; not stretchable; plain; snap-on type; yellow</p>	<p><a href="http://www.wago.com/248-501/000-002">www.wago.com/248-501/000-002</a></p>
	<p><b>Item no.: 248-501/000-012</b>                  Mini-WSB marking card; as card; not stretchable; plain; snap-on type; orange</p>	<p><a href="http://www.wago.com/248-501/000-012">www.wago.com/248-501/000-012</a></p>
	<p><b>Item no.: 248-501</b>                  Mini-WSB marking card; as card; not stretchable; plain; snap-on type; white</p>	<p><a href="http://www.wago.com/248-501">www.wago.com/248-501</a></p>
	<p><b>Item no.: 248-501/000-017</b>                  Mini-WSB marking card; as card; not stretchable; plain; snap-on type; light green</p>	<p><a href="http://www.wago.com/248-501/000-017">www.wago.com/248-501/000-017</a></p>
	<p><b>Item no.: 248-501/000-005</b>                  Mini-WSB marking card; as card; not stretchable; plain; snap-on type; red</p>	<p><a href="http://www.wago.com/248-501/000-005">www.wago.com/248-501/000-005</a></p>

Subject to changes. Please also observe the further product documentation!



**Item no.:** 248-501/000-024

Mini-WSB marking card; as card; not stretchable; plain; snap-on type; violet

[www.wago.com/248-501/000-024](http://www.wago.com/248-501/000-024)



**Item no.:** 248-501/000-023

Mini-WSB marking card; as card; not stretchable; plain; snap-on type; green

[www.wago.com/248-501/000-023](http://www.wago.com/248-501/000-023)



**Item no.:** 793-5501/000-007

WMB marking card; as card; for terminal block width 5 - 17.5 mm; stretchable 5 - 5.2 mm; plain; snap-on type; gray

[www.wago.com/793-5501/000-007](http://www.wago.com/793-5501/000-007)



**Item no.:** 793-5501/000-012

WMB marking card; as card; for terminal block width 5 - 17.5 mm; stretchable 5 - 5.2 mm; plain; snap-on type; orange

[www.wago.com/793-5501/000-012](http://www.wago.com/793-5501/000-012)



**Item no.:** 793-5501/000-017

WMB marking card; as card; for terminal block width 5 - 17.5 mm; stretchable 5 - 5.2 mm; plain; snap-on type; light green

[www.wago.com/793-5501/000-017](http://www.wago.com/793-5501/000-017)



**Item no.:** 793-5501/000-023

WMB marking card; as card; for terminal block width 5 - 17.5 mm; stretchable 5 - 5.2 mm; plain; snap-on type; green

[www.wago.com/793-5501/000-023](http://www.wago.com/793-5501/000-023)



**Item no.:** 793-5501/000-024

WMB marking card; as card; for terminal block width 5 - 17.5 mm; stretchable 5 - 5.2 mm; plain; snap-on type; violet

[www.wago.com/793-5501/000-024](http://www.wago.com/793-5501/000-024)



**Item no.:** 793-501/000-002

WMB marking card; as card; not stretchable; plain; snap-on type; yellow

[www.wago.com/793-501/000-002](http://www.wago.com/793-501/000-002)



**Item no.:** 793-501/000-007

WMB marking card; as card; not stretchable; plain; snap-on type; gray

[www.wago.com/793-501/000-007](http://www.wago.com/793-501/000-007)



**Item no.:** 793-501/000-017

WMB marking card; as card; not stretchable; plain; snap-on type; light green

[www.wago.com/793-501/000-017](http://www.wago.com/793-501/000-017)



**Item no.:** 793-501/000-012

WMB marking card; as card; not stretchable; plain; snap-on type; orange

[www.wago.com/793-501/000-012](http://www.wago.com/793-501/000-012)

Subject to changes. Please also observe the further product documentation!

WAGO GmbH & Co. KG

Hansastr. 27

32423 Minden

Phone: +49571 887-0 | Fax: +49571 887-169

Email: [info.de@wago.com](mailto:info.de@wago.com) | Web: [www.wago.com](http://www.wago.com)

Do you have any questions about our products?

We are always happy to take your call at +49 (571) 887-44222.



**Item no.: 793-501/000-023**  
WMB marking card; as card; not stretchable; plain; snap-on type; green

[www.wago.com/793-501/000-023](http://www.wago.com/793-501/000-023)



**Item no.: 793-501/000-006**  
WMB marking card; as card; not stretchable; plain; snap-on type; blue

[www.wago.com/793-501/000-006](http://www.wago.com/793-501/000-006)



**Item no.: 793-501/000-005**  
WMB marking card; as card; not stretchable; plain; snap-on type; red

[www.wago.com/793-501/000-005](http://www.wago.com/793-501/000-005)



**Item no.: 793-501**  
WMB marking card; as card; not stretchable; plain; snap-on type; white

[www.wago.com/793-501](http://www.wago.com/793-501)



**Item no.: 793-501/000-024**  
WMB marking card; as card; not stretchable; plain; snap-on type; violet

[www.wago.com/793-501/000-024](http://www.wago.com/793-501/000-024)



**Item no.: 793-5501/000-005**  
WMB marking card; as card; for terminal block width 5 - 17.5 mm; stretchable 5 - 5.2 mm; plain; snap-on type; red

[www.wago.com/793-5501/000-005](http://www.wago.com/793-5501/000-005)



**Item no.: 793-5501/000-002**  
WMB marking card; as card; for terminal block width 5 - 17.5 mm; stretchable 5 - 5.2 mm; plain; snap-on type; yellow

[www.wago.com/793-5501/000-002](http://www.wago.com/793-5501/000-002)



**Item no.: 793-5501/000-006**  
WMB marking card; as card; for terminal block width 5 - 17.5 mm; stretchable 5 - 5.2 mm; plain; snap-on type; blue

[www.wago.com/793-5501/000-006](http://www.wago.com/793-5501/000-006)



**Item no.: 793-5501**  
WMB marking card; as card; for terminal block width 5 - 17.5 mm; stretchable 5 - 5.2 mm; plain; snap-on type; white

[www.wago.com/793-5501](http://www.wago.com/793-5501)



**Item no.: 2009-115/000-012**  
WMB-Inline; for Smart Printer; 1500 pieces on roll; stretchable 5 - 5.2 mm; plain; snap-on type; orange

[www.wago.com/2009-115/000-012](http://www.wago.com/2009-115/000-012)



**Item no.: 2009-115/000-006**  
WMB-Inline; for Smart Printer; 1500 pieces on roll; stretchable 5 - 5.2 mm; plain; snap-on type; blue

[www.wago.com/2009-115/000-006](http://www.wago.com/2009-115/000-006)

Group marker carrier



**Item no.: 2009-193**  
Group marker carrier; gray

[www.wago.com/2009-193](http://www.wago.com/2009-193)

Subject to changes. Please also observe the further product documentation!



Item no.: 2009-192  
Group marker carrier; gray

[www.wago.com/2009-192](http://www.wago.com/2009-192)



Item no.: 2009-191  
Group marker carrier; gray

[www.wago.com/2009-191](http://www.wago.com/2009-191)

## Downloads

### Documentation

#### Bid Text

2210-1301 docx - Datei	2019 Apr 15	docx 15.3 kB	Download
---------------------------	-------------	-----------------	----------

2210-1301 X81 - Datei	2019 Apr 15	xml 4.1 kB	Download
--------------------------	-------------	---------------	----------

#### Additional Information

Technical Section Technical explanations		pdf 2.2 MB	Download
---	--	---------------	----------

## CAD/CAE-Data

### CAE data

ZUKEN Portal 2210-1301		URL	Download
------------------------	--	-----	----------

EPLAN Data Portal 2210-1301		URL	Download
-----------------------------	--	-----	----------

### CAD data

2D/3D Models 2210-1301		URL	Download
------------------------	--	-----	----------

## Environmental Product Compliance

### Compliance Search

Environmental Product Compliance 2210-1301		URL	Download
--	--	-----	----------

3-conductor through terminal block; with push-button; 10 mm<sup>2</sup>; with test port; side and center marking; for DIN-rail 35 x 15 and 35 x 7.5; Push-in CAGE CLAMP®; 10,00 mm<sup>2</sup>; gray

Subject to changes. Please also observe the further product documentation!

## Installation Notes

### Conductor termination

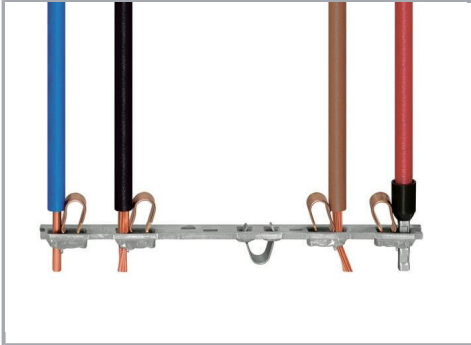

All conductor types at a glance



Push-in termination of solid and ferruled conductors



Insert fine-stranded conductors via operating tool.



Removing all conductors via operating tool.

### Commoning



Insert a push-in type jumper bar and push down until it hits the backstop.

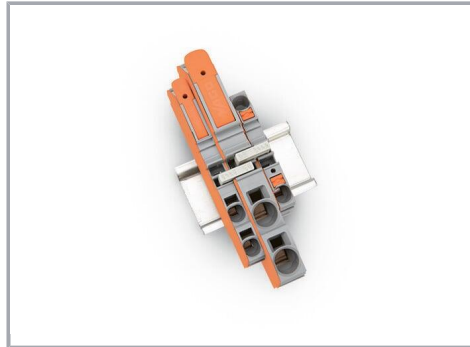

Commoning with step-down jumpers.

### Testing

Subject to changes. Please also observe the further product documentation!

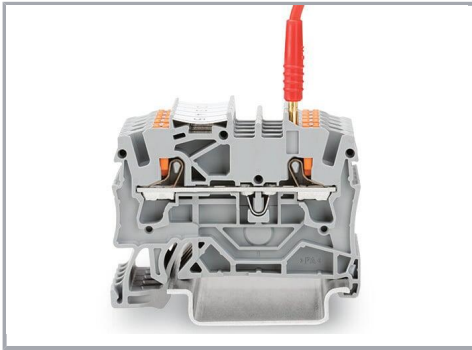

Testing with a 2 mm Ø test plug (max. 42 V).

### Marking

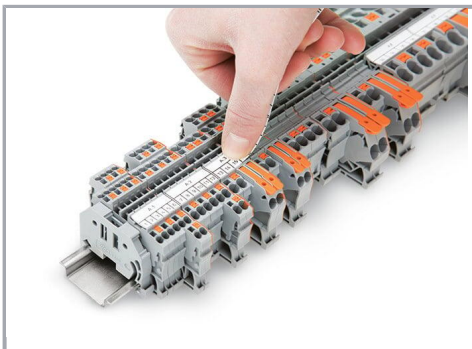

Snapping a marking strip into a marker slot.

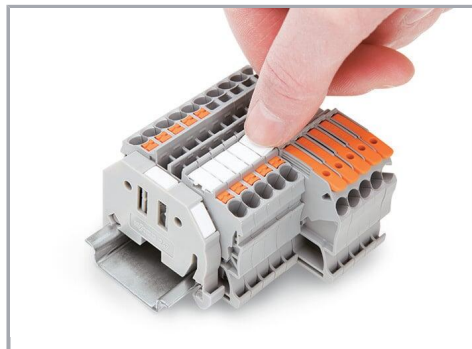

Snapping a marking strip into the marker slot.

### Product family

#### TOPJOB® S

TOPJOB® S: In various industrial applications and modern building installations, WAGO's wide and versatile range of rail-mount terminal blocks provides more than just reliable electrical connections.

[Show all products from the family](#)

Subject to changes. Please also observe the further product documentation!